

SOLARTEC®

KS100T

HIGH EFFICIENCY POLYCRYSTALLINE PHOTOVOLTAIC MODULE

TYPICAL OUTPUT 100 Wp

MADE IN ARGENTINA



SPECIFICATIONS

Solartec modules are manufactured with highly efficient polycrystalline photovoltaic cells produced by Kyocera in Japan. The conversion efficiency of these cells is over 14 %.

These cells are encapsulated between a tempered glass cover and an EVA pottant with TPE back sheet to provide maximum protection from the severest environmental conditions.

The entire laminate is installed in an anodized aluminum frame to provide structural strength and ease of installation. The junction box at the back sheet is used for the interconnection with the other components of the system.

■ Electrical Specifications

Nominal Power (NP)	100 Wp
Voltage @ NP	18,3 V
Current @ NP	5,46 A
Open Circuit Voltage	22,1 V
Short Circuit Current	5,86 A

■ Physical Specifications

Length	1028 mm
Width	668 mm
Depth	36 mm
Weight	8,00 Kg

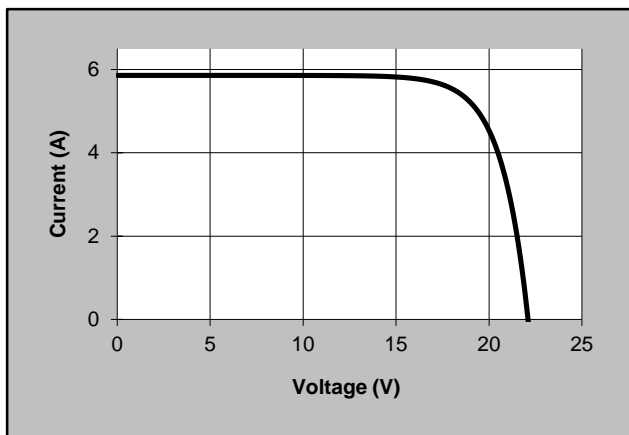

The electrical specifications are under test conditions of irradiance of 1 kW/m², Spectrum of 1.5 air mass and cell temperature of 25°C.
Minimum Power Output = Nominal Power - 10 %

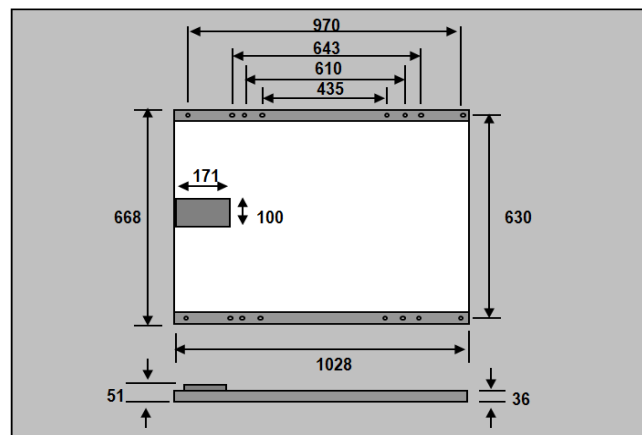

All the distances are in mm.

SOLARTEC S.A.

México 2145 – 1640 Martínez - Buenos Aires – Argentina
TE: 54-11-4836-1040 Fax: 54-11-4836-1381
info@solartec.com.ar www.solartec.com.ar

The contents of this catalogue are subjected to change without prior notice.

ETE KS100T v1