







ABOUT GREALTEC

GREALTEC, with over 10 years of industry experience, has been an integral part in the development of alternative energy in Europe, bringing their knowledge, experience and management in the entire process of product design and manufacturing of solar photovoltaic systems, from standard solutions to products developed to suit the requirements of our customers.

KEY FEATURE

-  High module conversion efficiency, up to 16 %, through latest manufacturing technology.
-  Exceptional behavior under low light intensity.
-  Qualified and personal technical support.
-  Constant innovation and research.
-  Entire module certified to withstand snow loads (5400 Pascal) and high wind loads (2400 Pascal).

QUALITY & SAFETY

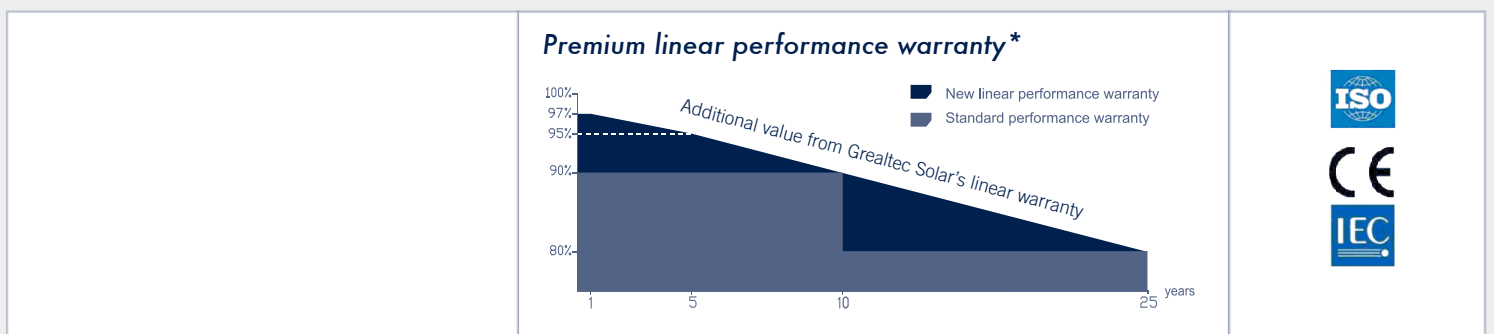

RECOMMENDED APPLICATIONS

-  OFFGRID ROOF-TOPS
-  SOLAR POWER PLANTS
-  OFFGRID SYSTEMS

CONSTRUCTIVE CHARACTERISTICS



- 1 JUNCTION BOX
- 2 BACKSIDE FOIL
- 3 EVA
- 4 MULTI-CRYSTALLINE CELL
- 5 EVA
- 6 GLASS PLATE
- 7 FRAME

ENGINEERING DRAWING

Unit: mm

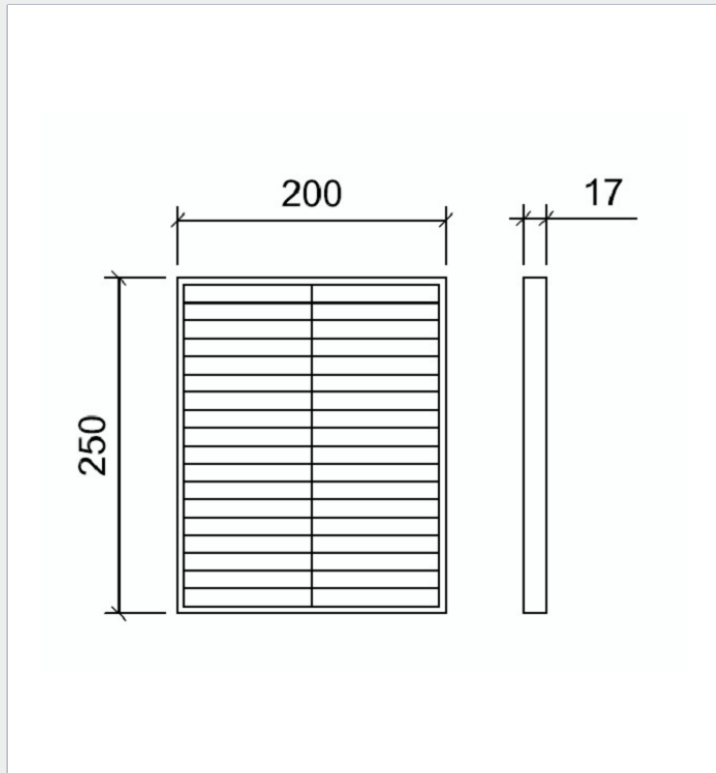

ELECTRICAL PERFORMANCE & TEMPERATURE DEPENDENCE

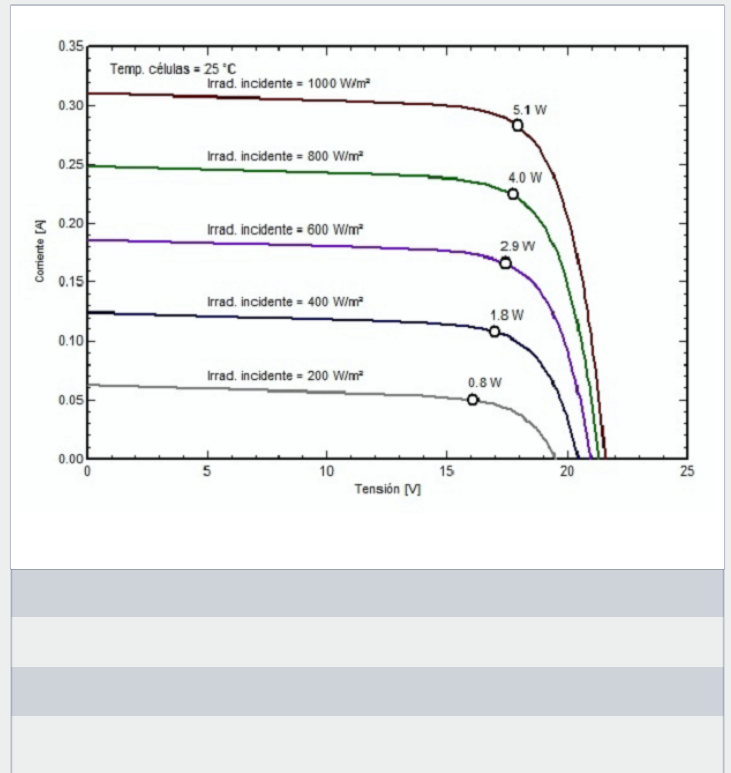

ELECTRICAL DATA

MECHANICAL DATA

PACKAGING SPECIFICATIONS

STC



IRRADIANCE 1000W/M2



MODULE TEMPERATURE 25°C



AM=1.5



Read the instruction manual in its entirety before handling, installing, and operating Grealtec solar modules. Due to continuous innovation, research and product improvement, technical datasheet are subject to change without prior notice.

Grealtec reserves the final right for explanation on any of the information presented hereby.