



EnerSol 30

+ 0/+5 WP POSITIVE TOLERANCE

🏠 ROOFTOP AND OFF-GRID DESIGN

✓ HIGH QUALITY

25 year linear performance warranty
10 year product warranty



enerSol

High quality solar panels designed
for rooftop and off-grid applications



EnerSol 30

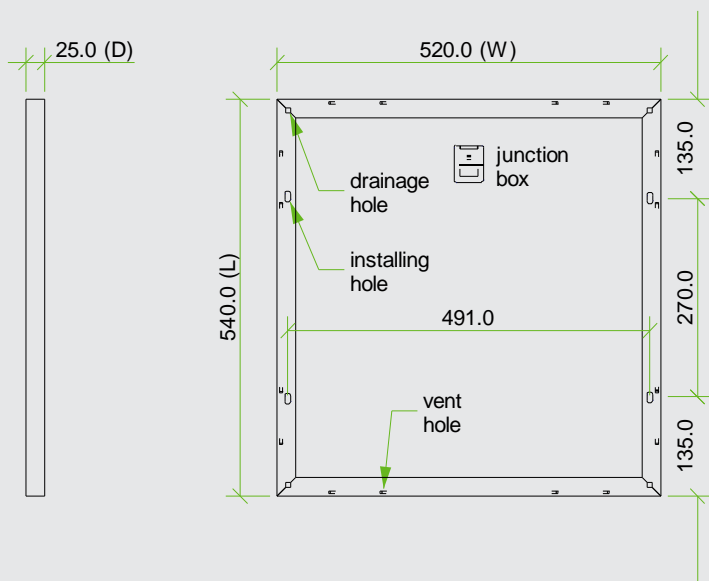

General characteristics

Cell	Polycrystalline solar cell 78 x 73 mm
No. of Cells (Connections)	36 (6x6)
Panel Dimensions	540 x 520 x 25 mm
Weight	3.4 kg
Connectors and Cables	Available upon request

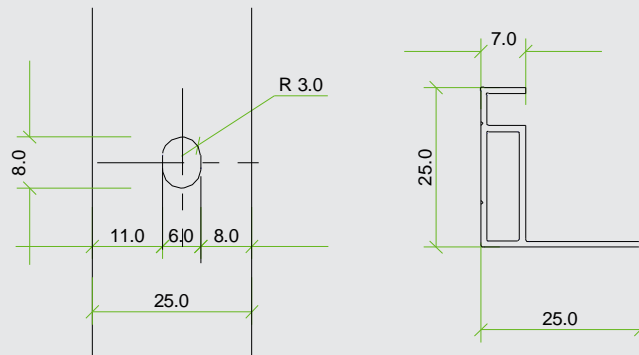

Thermal conditions

Normal Operating Cell Temperature 800W/m ² Irradiance, 20°C, AM = 1.5	48°C ± 2°C
Power Temperature Coefficient	- 0.5%/K
Current Temperature Coefficient	0.035%/K
Voltage Temperature Coefficient	- 0.37 MV/K

Limits

Operating Temperature	- 40°C to 85°C
Maximum System Voltage	1000V DC

Electric performance at STC *

Maximum Power	30 Wp
Power Tolerance	0/+5 Wp
Maximum Power Voltage	18 V
Maximum Power Current	1.67 A
Open Circuit Voltage	22.0 V
Short Circuit Current	2.01 A

*Standard Test Conditions : 1000W/m² irradiance, 25°C and AM = 1.5

High performance

25 25 Years
linear performance

10 10 Years
product warranty

