

PVT SOLID PRO M.60 300

GLASS/GLASS MONOCRYSTALLINE 60 cell module

PVT
AUSTRIA

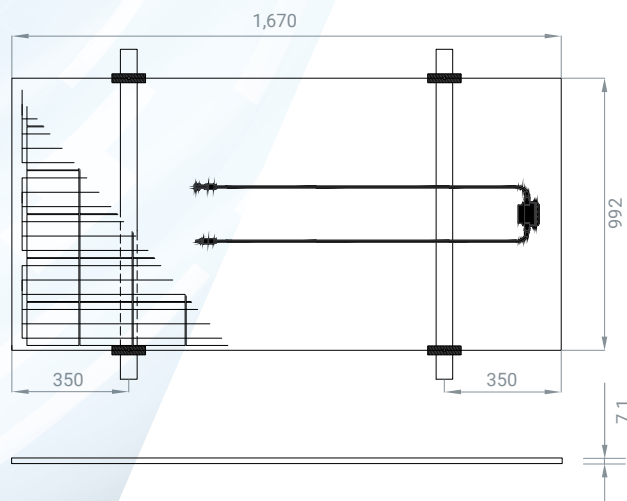

Working conditions

MAX. SYSTEM VOLTAGE	1,000 V
OPERATING TEMPERATURE	-40°C / +85°C
MAX. CURRENT	15 A
MAX. WIND/SNOW LOAD	2,400 Pa / 8,000 Pa
POWER TOLARANCE	0/+5 W
IP PROTECTION LEVEL	67
SAFETY CLASS	II

Electrical data (STC*)

MAX. POWER* (PMPP)	300 W
RATED VOLTAGE (VMPP)	32.15 V
RATED CURRENT (IMPP)	9.35 A
OPEN CIRCUIT VOLTAGE (VOC)	39.45 V
SHORT CIRCUIT CURRENT	9.90 A
POWER TOLARANCE	0/+5%
MODULE EFFICIENCY	18.11%

Flash testing measurement accuracy of +/-5%

*Under standard test conditions (STC) of irradiance of 1000 W/sq.m., spectrum AM 1.5 and cell temp. of 25°C

Temperatur ratings

VOLTAGE TEMP. COEFF. (β)	-0.35%/K
CURRENT TEMP. COEFF. (α)	+0.04%/K
POWER TEMP. COEFF. (δ)	-0.47%/K

Mechanical data

CELL SIZE	156.75 x 156.75 mm
NUMBER OF CELLS	6 x 10
FRONT/BACK GLASS	3.15 mm hardened solar glass
WEIGHT	27 kg
DIMENSIONS (L x W x H mm)	1,670 x 992 x 7.1
J-BOX	TE Connectivity J-box IP67
CABEL LENGTH	0.8–1.1 m
CABEL CROSS SECTION SIZE	4 mm ²
NUMBER OF DIODES	3
PLU-IN CONNECTION	PV4-S Male/Female
FRAME	frameless
TRANSPARENCY	10%

Certific



Product warranty



Efficiency guarantee

