







# SOLAR MODULE EGE-110M-36 MONOCRYSTALLINE MODULE

110 W / 36 Cells / 5 Busbars cells



Eco Green Energy's modules are only made of grade A solar cells with a very high efficiency and ensured more than 25 years lifespan.

## KEY FEATURES

-  5 bus bars cells, with efficiency up to 19 %
-  IP65 or IP67 junction box for long term weather endurance
-  High quality aluminum frame, resisting load up to 5400 Pa and wind pressure up to 2400 Pa
-  High transmissivity, low-iron tempered glass
-  High performance in low-light environment
-  Double EL test before and after lamination

## CERTIFICATES

IEC 61215 / IEC 61730 / CE  
ISO 9001:2015

**25 YEARS** OUTPUT POWER WARRANTY

**10 YEARS** PRODUCT WARRANTY

## LINEAR PERFORMANCE WARRANTY

10-Year Product Warranty · 25-Year Linear Power Warranty

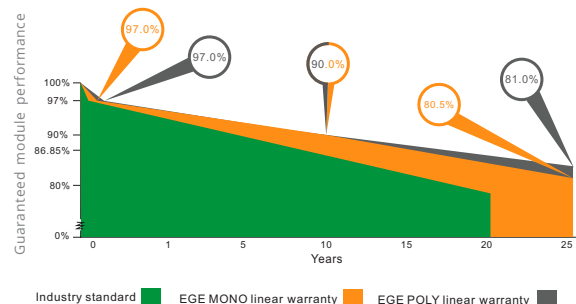

## ELECTRICAL DATA AT STC\*

Power output (Pmax)	110 W
Power tolerance	0~+5 %
Module efficiency	16.10 %
Maximum power voltage (Vmp)	18.74 V
Maximum power current (Imp)	5.87 A
Open circuit voltage (Voc)	22.64 V
Short circuit current (Isc)	6.15 A

\*Standard Test Conditions: Irradiance: 1 000 W / m<sup>2</sup>  
Cell temperature: 25 °C • AM: 1.5

## ELECTRICAL DATA AT NOCT\*

Power output (Pmax)	82.02 W
Maximum power voltage (Vmp)	17.57 V
Maximum power current (Imp)	4.66 A
Open circuit voltage (Voc)	21.00 V
Short circuit current (Isc)	5.00 A

\*Nominal Operating Cell Temperature: Irradiance: 800 W / m<sup>2</sup>  
Ambiant temperature: 20 °C • AM: 1.5 • Wind speed: 1 m/s

## TEMPERATURE CHARACTERISTICS

NOCT	45 °C ±2 °C
Temperature coefficient of Pmax	-0.41%/°C
Temperature coefficient of Voc	-0.31%/°C
Temperature coefficient of Isc	+0.06%/°C

## MAXIMUM RATINGS

Operating temperature range	-45 °C ~+85 °C
Maximum system voltage	1000 V
Max series fuse rating	10 A
Max front load (e.g.: snow)	5 400 Pa
Max back load (e.g.: wind)	2 400 Pa

## MECHANICAL CHARACTERISTICS

Cell type	Monocrystalline (156x104 mm)
Number of cells	36
Dimensions	1020x670x30 mm
Weight	7.7 kg
Glass	3.2 mm tempered glass
Frame	Anodized aluminium alloy
Junction box	IP65 or IP67
Cable	0.9 m
Connector	MC4 or MC4 compatible

## EGE-110M-36 / I-V CURVES

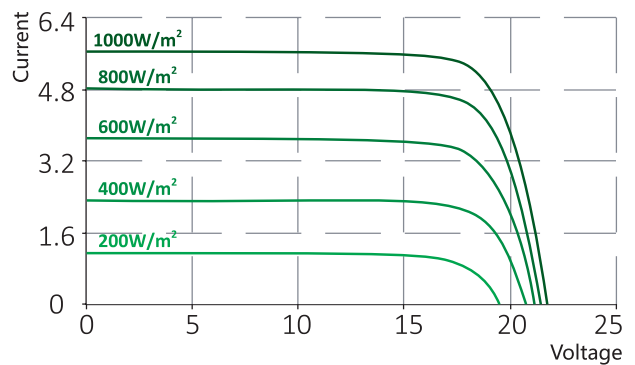

## ENGINEERING DRAWINGS (mm)

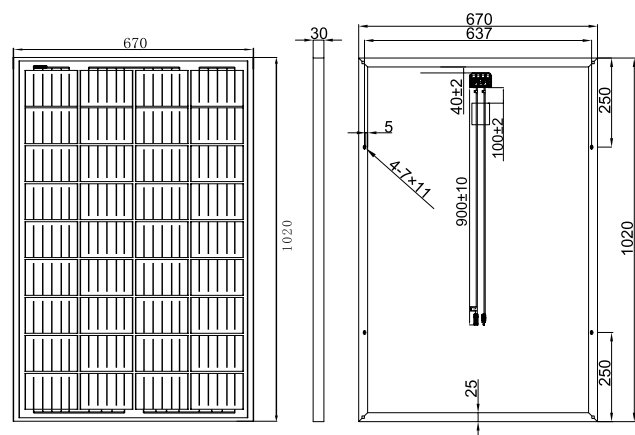

## PACKAGING

Type	Pcs/ Type	Weight
Per Box	2 pcs	17 kgs
20ft GP Container	1000 pcs	8.2 t
40ft GP Container	2100 pcs	17.22 t
40ft HQ Container	2400 pcs	19.68 t