

AB-60PHC

Lower current and series resistance

Half Cell polycrystalline PV modules

280W
285W
290W



Higher output, efficiency & ROI due to reduced "Cell To Module" loss.



6% Less Internal Power Loss due to shorter ribbon length.



50% Higher Yield due to better shading response



Twice Less Mismatch Loss due to double internal strings of cells.

WHY ABI-SOLAR?

- ① Manufacturing and assembly of PV modules are performed only on East Asian enterprises from **Bloomberg Tier 1** list.
- ① PV modules are tested and demonstrate high reliability in various climatic conditions and in a wide range of insolation.
- ① High efficiency and return on investment guaranteed around the world.
- ① Modules certified by global testing facilities: IEC61215, IEC61730, CE, ROHS, TÜV.
- ① Manufacturing with international quality standards and environment management system: ISO9001 and ISO14001.
- ① Maximum power and performance at minimal price ensure fast return of investments.
- ① Compatibility with both on-grid and off-grid PV systems guaranteed.

12

YEAR

Manufacturing Warranty

25

YEAR WARRANTY

80% Power Output

INDUSTRY-LEADING WARRANTY BASED ON NOMINAL POWER

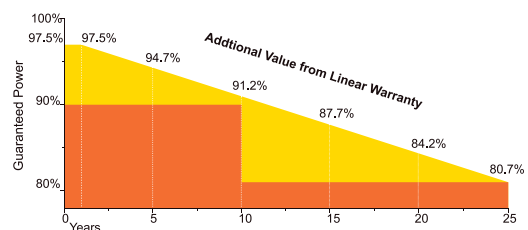

Specifications are subject to change without prior notification

MECHANICAL DRAWINGS

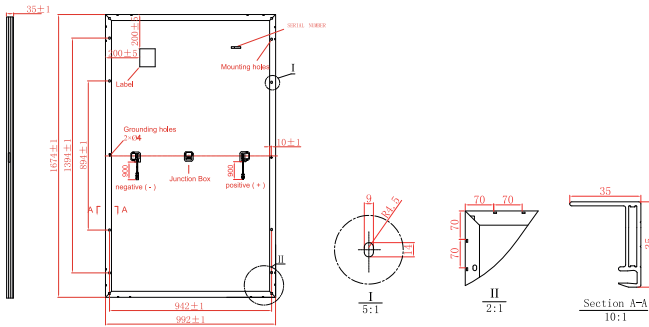

MECHANICAL SPECIFICATIONS

Cell type	Poly Crystalline
Dimensions (A×B×C)	1674x992x35 mm
Weight	18.5 kg
Front Glass	High transmission tempered glass
Frame	Anodized aluminium alloy
Junction Box	IP67
Connector	MC4 compatible
Output cables	4.0mm ² (IEC) cable length: 900mm
Maximum snow load (IEC 61215)	5400 Pa

ELECTRICAL CHARACTERISTICS (STC)

	AB280-60PHC	AB285-60PHC	AB290-60PHC
Maximum Power (Pmax)	280W	285W	290 W
Short Circuit Current (Isc)	9.24A	9.32A	9.39A
Open Circuit Voltage (Voc)	38.2 V	38.5 V	38.8 V
Maximum Power Current (Impp)	8.75A	8.83A	8.9A
Maximum Power Voltage (Vmpp)	32.0 V	32.3 V	32.6 V
Module Efficiency	16.8%	17.16%	17.46%
Power Tolerance	0~+4.99 W		
Maximum Series Fuse	20A		
Maximum System Voltage	1000V/1500V DC(IEC)		

NOCT

	AB280-60PHC	AB285-60PHC	AB290-60PHC
Maximum Power (Pmax)	205.8W	209.4W	213.1W
Short Circuit Current (Isc)	7.43A	7.50A	7.55A
Open Circuit Voltage (Voc)	35.44V	35.72V	36.0V
Maximum Power Current (Impp)	6.98A	7.05A	7.34A
Maximum Power Voltage (Vmpp)	29.48V	29.76V	30.03V

STC irradiance: 1000 W/m² module temperature: +25 °C AM=1.5

NOCT irradiance: 800 W/m² module temperature: +20 °C AM=1.5

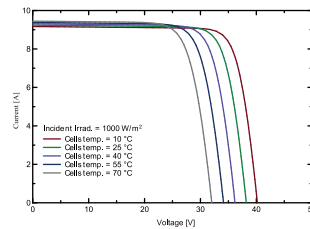
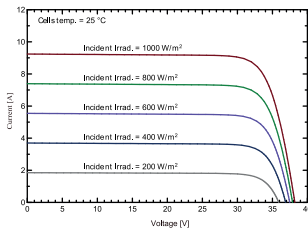

TEMPERATURE CHARACTERISTICS

Nominal Operating Cell Temperature (NOCT)	45° C ± 2 °C
Temperature Coefficient of Pmax	- 0.38% °C
Temperature Coefficient of Voc	- 0.30% °C
Temperature Coefficient of Isc	0.05 °C
Operating Temperature	- 40 °C ... +85 °C

PACKING CONFIGURATION

	1674x 992x 35 mm	
Container	20'HQ	40'HQ
Pieces per Pallet	30	30
Pallets per Container	12	26
Pieces per Container	360	780

QUALIFICATIONS AND CERTIFICATES





Half Cell PV Modules. What does it mean?

Half Cell module consists of conventional polycrystalline silicon cells cut in half. So 60-cells standard PV module becomes 120-cells half-cell PV module.

Why Do We Cut the Cells?

Shorter Bus Bars

The shorter conductor, the less amperage, the lower resistance. Lower resistance reduces power loss up to 6% and increase the output power from 5W to 8W.

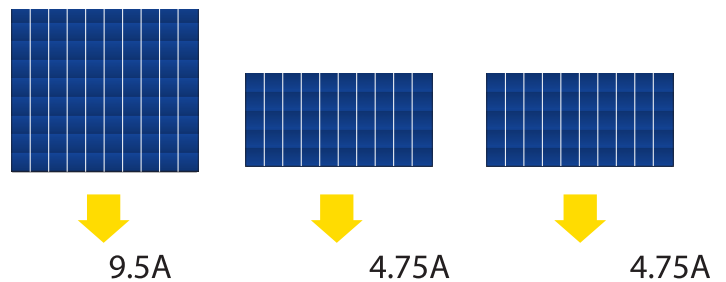

More Strings

Instead of 6 strings of cells in conventional 60-cells module, half-cell module includes 12 strings. It deals with the performance mismatch happened between cells caused by shading, cells' initial heterogeneity and uneven degradation.

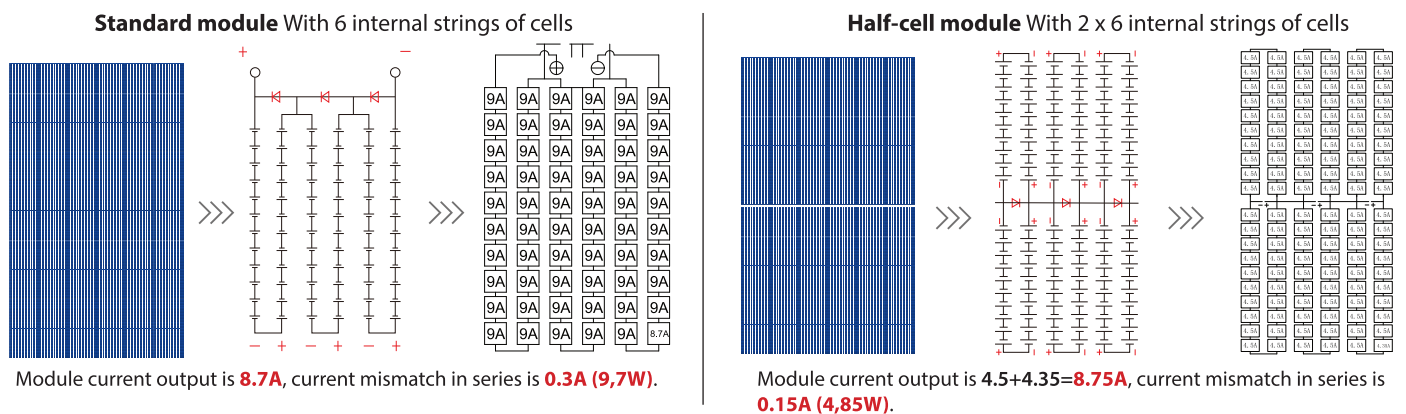

Smaller Cells

The twice smaller cells generate smaller currents that help reduce "Cell To Module" loss. Smaller cell also means twice less damage from micro-cracks in the cell and stains on the glass for the hole module.

How does it improve our modules?

Compared to standard PV modules our new half-cell modules are more efficient, have higher performance and less prone to overheating. They better cope with partial shading and are less vulnerable to point mechanical damage and dirt.

half-cell module

standard module

Performance & Efficiency

Efficiency upto **17.41%**

Efficiency **16%**

Overheating

Cell's operating current 4.75A
16.5% lower risk of hot-spots due to lower temperature in partially shaded cells

Cell's operating current 9.5A
Higher risk of hot-spots in partially shaded cells

Partial Shading

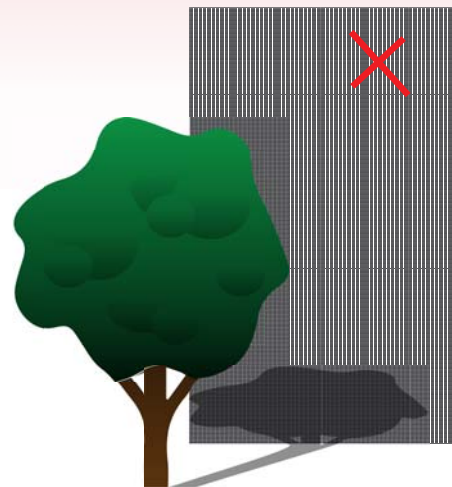
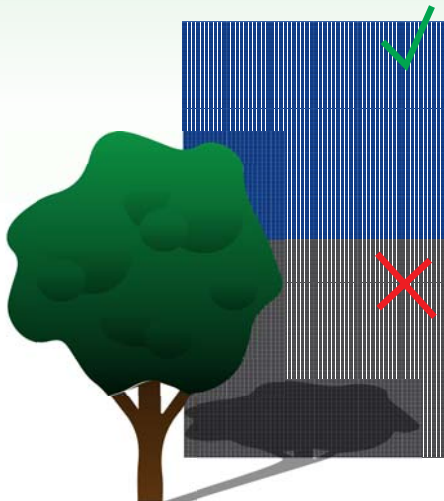

Point mechanical damage and dirt

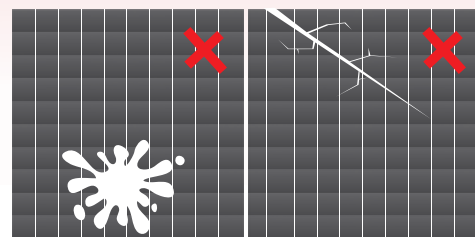
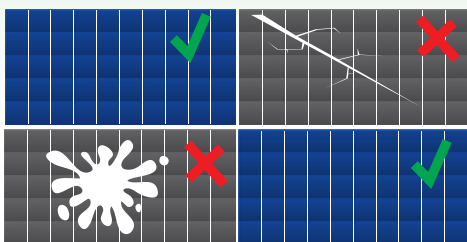

And the last, but not least, half-cell PV modules has higher ROI!