

Leading - edge Technology

- ▶ Special for commercial plant application
- ▶ Dual independent MPP tracking and advanced MPPT algorithms lead to optimal energy harvesting
- ▶ Consistent and stable performance across entire input voltage and output power range
- ▶ Integrated DC disconnect switch
- ▶ High efficiency of 97.5% delivery more energy
- ▶ Ethernet / RF technology / WiFi
- ▶ Easy installation and maintenance procedure
- ▶ Innovative device designed and Intelligent applications
- ▶ Comprehensive protection for IGBTs, overvoltage, short-circuit, overload, overheat, etc
- ▶ Flexible system design with safety fuse module, lightning protection module and AFCI module

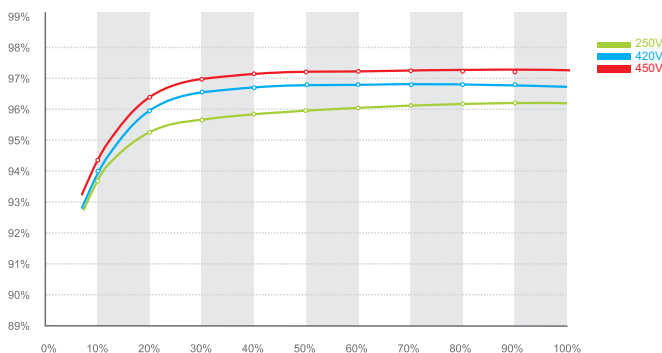

Growatt 20000 TL3-US efficiency



Growatt 10-20K TL3-US topology

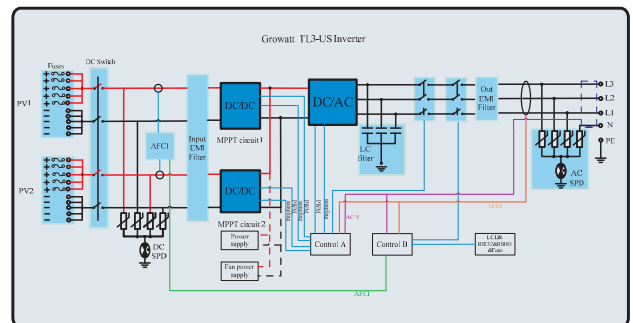

Datasheet	Growatt 10000TL3-US	Growatt 12000TL3-US	Growatt 18000TL3-US	Growatt 20000TL3-US
Input Data				
Max. DC power	10500W	12500W	18750W	20850W
Max. DC voltage	600V	600V	600V	600V
Start voltage	120V	120V	120V	120V
DC nominal voltage	375V	375V	375V	375V
PV voltage range	80V - 600V	80V - 600V	80V - 600V	80V - 600V
MPP voltage range (Full load)	250V - 600V	250V - 600V	250V - 600V	250V - 600V
Number of independent MPP trackers/strings per MPP tracker	2 / 3	2 / 3	2 / 5	2 / 5
Max. input current of MPP Tracker A / Tracker B	21A / 21A	25A / 25A	38A / 38A	42A / 42A
Output (AC)				
Rated AC output power	10000W	12000W	18000W	20000W
Rated AC voltage	480V	480V	480V	480V
AC voltage range	422-528VAC	422-528VAC	422-528VAC	422-528VAC
AC grid frequency; range	60 Hz;59.3-60.5 Hz	60 Hz;59.3-60.5 Hz	60 Hz;59.3-60.5 Hz	60 Hz;59.3-60.5 Hz
Max. output current(cos φ=1)	12A	14.5A	21.5A	24A
Power factor (cos φ)	>0.99 (0.9Leading - 0.9Lagging)	>0.99 (0.9Leading - 0.9Lagging)	>0.99 (0.9Leading - 0.9Lagging)	>0.99 (0.9Leading - 0.9Lagging)
Harmonics	<3%	<3%	<3%	<3%
Grid connection type	3/N/E	3/N/E	3/N/E	3/N/E
Efficiency				
Max. efficiency	97%	97%	97.5%	97.5%
CEC-Weighted Efficiency	95.5%	95.5%	96%	96.5%
MPPT efficiency	99.5%	99.5%	99.5%	99.5%
Protectopm devices				
DC switch for each MPP tracker	yes	yes	yes	yes
DC reverse-polarity protection	yes	yes	yes	yes
DC/AC over voltage protection-Varistor	yes	yes	yes	yes
DC/AC over voltage protection -DIN rail surge arrester(Optional)	Class II	Class II	Class II	Class II
DC insulation measure	yes	yes	yes	yes
AC short circuit protection	yes	yes	yes	yes
AFCI compliant to UL 1699B	yes	yes	yes	yes
General Data				
Dimensions (W / H / D) in inch	20.9/27.7/9.7	20.9/27.7/9.7	25.6/29.1/9.7	25.6/29.1/9.7
Weight	46kg/101.4lb	46kg/101.4lb	63kg/138.9lb	63kg/138.9lb
Operating temperature range	-25..+60°C/(-13...+ 140°F)	-25..+60°C/(-13...+ 140°F)	-25..+60°C/(-13...+ 140°F)	-25..+60°C/(-13...+ 140°F)
Noise emission	≤50dB(A)	≤50dB(A)	≤50dB(A)	≤50dB(A)
Self-Consumption (night)	< 3 W	< 3 W	< 3 W	< 3 W
Topology	Transformerless	Transformerless	Transformerless	Transformerless
Cooling concept	Fan Cool	Fan Cool	Fan Cool	Fan Cool
Electronics protection rating/connection area	NEMA 3R	NEMA 3R	NEMA 3R	NEMA 3R
Altitude	2000m without derating	2000m without derating	2000m without derating	2000m without derating
Relative Humidity	0~100%	0~100%	0~100%	0~100%
Features				
Display	Graphic	Graphic	Graphic	Graphic
Interfaces: RS232/RS485/Ethernet/RF/WiFi	yes / yes / opt / opt / opt	yes / yes / opt / opt / opt	yes / yes / opt / opt / opt	yes / yes / opt / opt / opt
Warranty: 5 years / 10 years	yes / opt	yes / opt	yes / opt	yes / opt

Certificates and Approvals

UL1741,UL1998 ,IEEE 1547, CSA C22.2 No.107.1-1,FCC Part15(Class A&B),UL1699B