

Micro Inverter WV230 User Manual

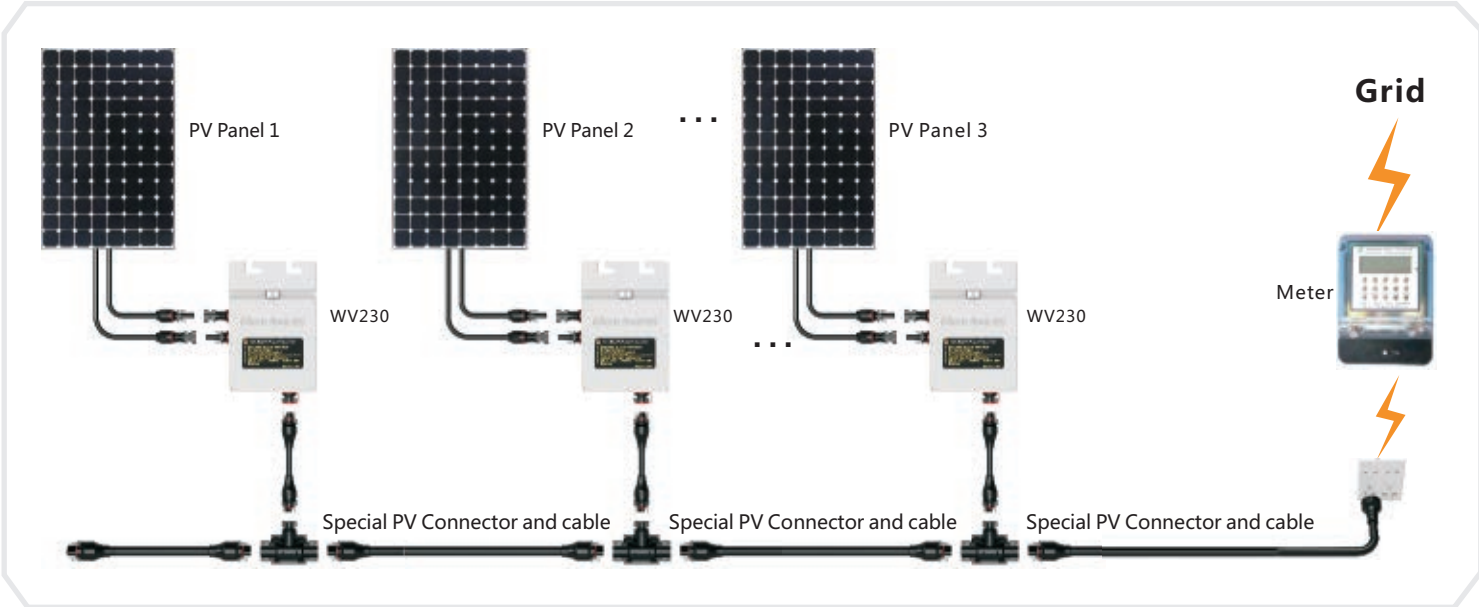

WV Series Installation



Case Diagram

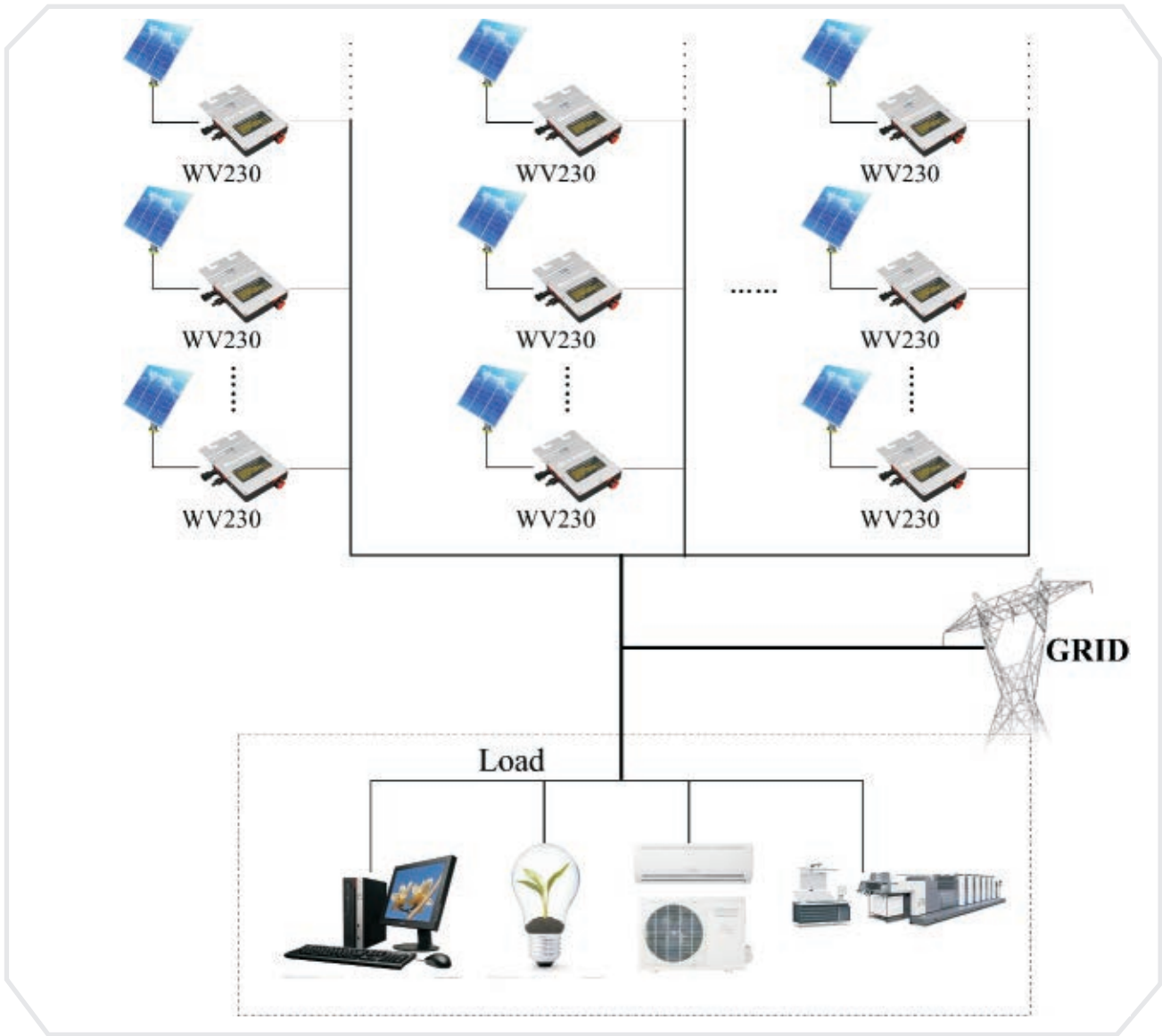

System Function

- ◆ **6-grade power search**---In overcast weather, the PV Panel' s output current is extremely tiny, then inverter will automatic open 6-grade power search function,and keep outputting efficient and steady during the low power .
- ◆ **Wide voltage input(22-50VDC)**---1.DC voltage input:22~50VDC; 2.Second level power variable voltage conversion.
- ◆ **High-frequency two-way and one-way grid function**---1.High frequency direct modulation, AC half wave synthesis;
2.Two-way grid means: Load consume directly. And can reverse AC current transmission.
- ◆ **Kinds of frequency output function**---1.It can apply to 50Hz and 60Hz frequency of AC;
2.Frequency range: 45 50 54/55 60 64 Hz;
- ◆ **Directly connected to the solar panels (do not need to connect the battery)**
- ◆ **AC 0 angle with high precision auto-detection**---High-precision analysing the AC phase angle .The phase shift rate is less than 1%, thus achieve high-precision with phase modulation AC output together.
1.AC phase shift: < 1%; 2.Over-zero protection: 0.2 VAC; 3.AC switching: 50Hz / 60Hz.
- ◆ **Synchronous High-frequency Modulation**
1.Modulation synthesis: half wave and full-bridge modulation synthesis (100Hz / 120Hz) ;
2.Synthetic way: MOSFET full-bridge; 3.High frequency: 50KHz.
- ◆ **Pure Sine Wave Output**---Use SPWM directly to make pure sine wave output.
1.Output waveform: Adopt complementary PWM to push-pull pure sine wave; 2.Generate means: enhancement-mode SPWM.
- ◆ **Power Automatically Locked (APL)**--- automatically powers locked in maximum power point, made output more stable.
- ◆ **Constant Current, Constant Power**---constant current and output power, without any overload, over-current phenomenon.
- ◆ **Exactly and timely automatic Island Effect Protection**
- ◆ **High-Frequency High Conversion Rate**---Adapt high frequency converter, the output more efficient.
- ◆ **Maximum Power Point Tracking (MPPT)**---high-precision (MPPT) operation power, automatic and immediate adjust the solar panels output power at the maximum output point,made the inverter discharge to power grid with the highest efficiency.
- ◆ **Stack using**--- Such as: 4 micro inverter of 260W stacking can achieve 1040W. the number of the stacking is unlimited.
- ◆ **DC input**---Input voltage range: 22V to 50V,PV Panel: Recommend using the power more than 30W and the standard voltage of 36V PV panels.Suggestion making the PV in parallel.
- ◆ **AC output**---220VAC: 180V - 262V, 50HZ; 110V AC: 80V - 160V, 60HZ.

Notes:

- ★Please connect the inverter following the operation instruction show above. If have any question please contact with relative persons.
- ★Non-professionals do not disassemble.Only qualified personnel may repair this product.
- ★Please install inverter in the low humidity and well-ventilated place to avoid the inverter over-heating,and clear around the inflammable and explosive materials.
- ★When using this product, avoid children touching, playing, to avoid electric shock.
- ★Connected solar panels, battery or wind generators DC input DC power supply cable.

Accessories for product:

- 1.One warranty card;
- 2.One user manual;
- 3.One certificate of quality;
- 4.1 pouch of screw for micro inverter installation;
- 5.One AC Cable;

LED Display

- 1.Red light 3 second---Red LED light 3 second while device starts , then in working condition;
- 2.Green flash fast---MPPT searching;
- 3.Green flash slow---MPPT + searching;
4. Red flash slow---MPPT - searching;
- 5.Green lights on 3s and off 0.5s---MPPT locked;
- 6.Red light steady---a. Islanding protection;b.Over-temperature protection;c.Over / low AC voltage protection;
d. Over / low DC voltage protection; e.Fault

Remarks:

LED flashing in the process of being working condition:inverters connected to AC & DC sides→Red LED light 3 second→Green LED flash fast(MPPT searching)→Green LED flash slow(MPPT + searching) / Red LED flash slow (MPPT - searching) / reen LED lights on 3s and off 0.5s (MPPT locked) .

Parameter Table

Models	WV230-230V/50Hz/120V/60Hz
Recommend use PV panels	300W/Vmp>34V/Voc<50V
DC MAX input current	15A
AC MAX output power	260Watt
DC MAX Open-circuit input-voltage	50VDC
DC input voltage range	22~50VDC
MAX output power factor	0.99
DC input Reverse voltage protection	FUSE
AC output voltage range	80V 125V 160V/180V 230V 262V
AC frequency range	45 50 54/55 60 64 Hz
THDIAC	<5%
AC Phase	<0.5%
Islanding protection	VAC ; fAC
Output short circuit protection	Current-limiting
Led Display	Refer to "LED Display"
Communication	power line carrier-current communication
Standby Power	<1W
Night Power	<1W
Ambient temperature range	-40 °C~65°C
Humidity	0~100%
Waterproof	IP67
Network test	DIN VDE 1026 UL1741
Certificate	CEC

Packing and weight

Net weight	0.65kg
Gross weight	0.85kg
Size(L x W x H)	195×130×32mm
Package(L x W x H)	Inner box:24.5x20x6CM Big box:41.8x38.8x26.8CM
Installation	fixed the inverter on the PV holder

Installation Of Micro Inverter

Step1 Installation for fixed the inverter on the PV holder with the screws attached is as following:

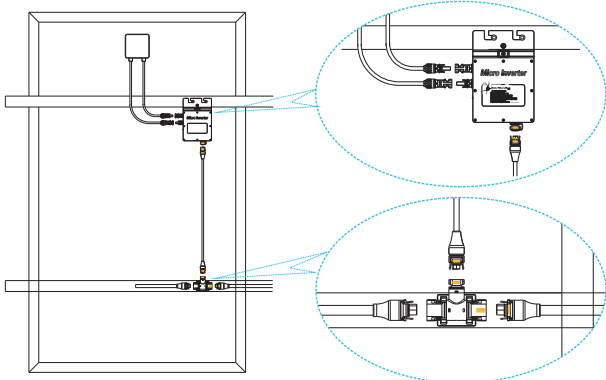

Step2 Connect the two DC terminal of the PV to the inverter, positive to positive, negative to negative. Show below:

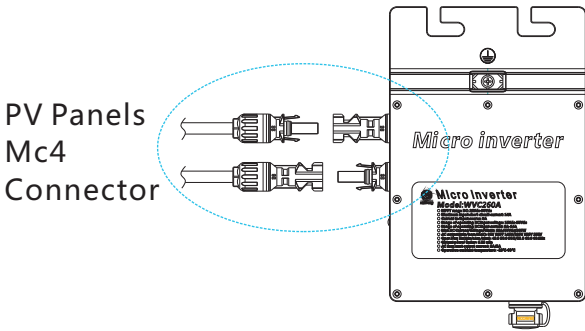

Step3 Open the waterproof cap on AC output side of the micro inverter, then plug to AC power line. Show below:

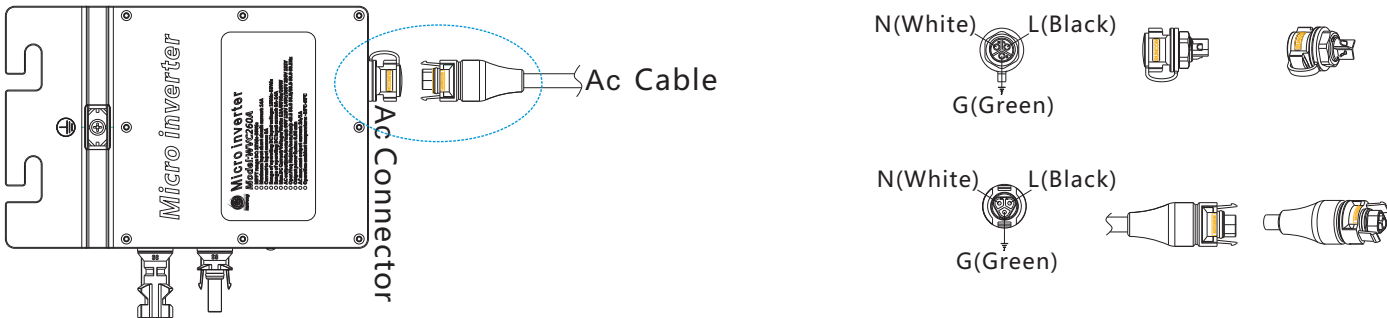

Step4 Plug the AC output line to main AC cable;

Step5 Repeat the first step to the third step to complete the installation of micro inverters;

Step6 Finally, please connect the AC main cable to the utility grid to run renewable energy and saving \$\$\$!

Installation Of Ground Wire

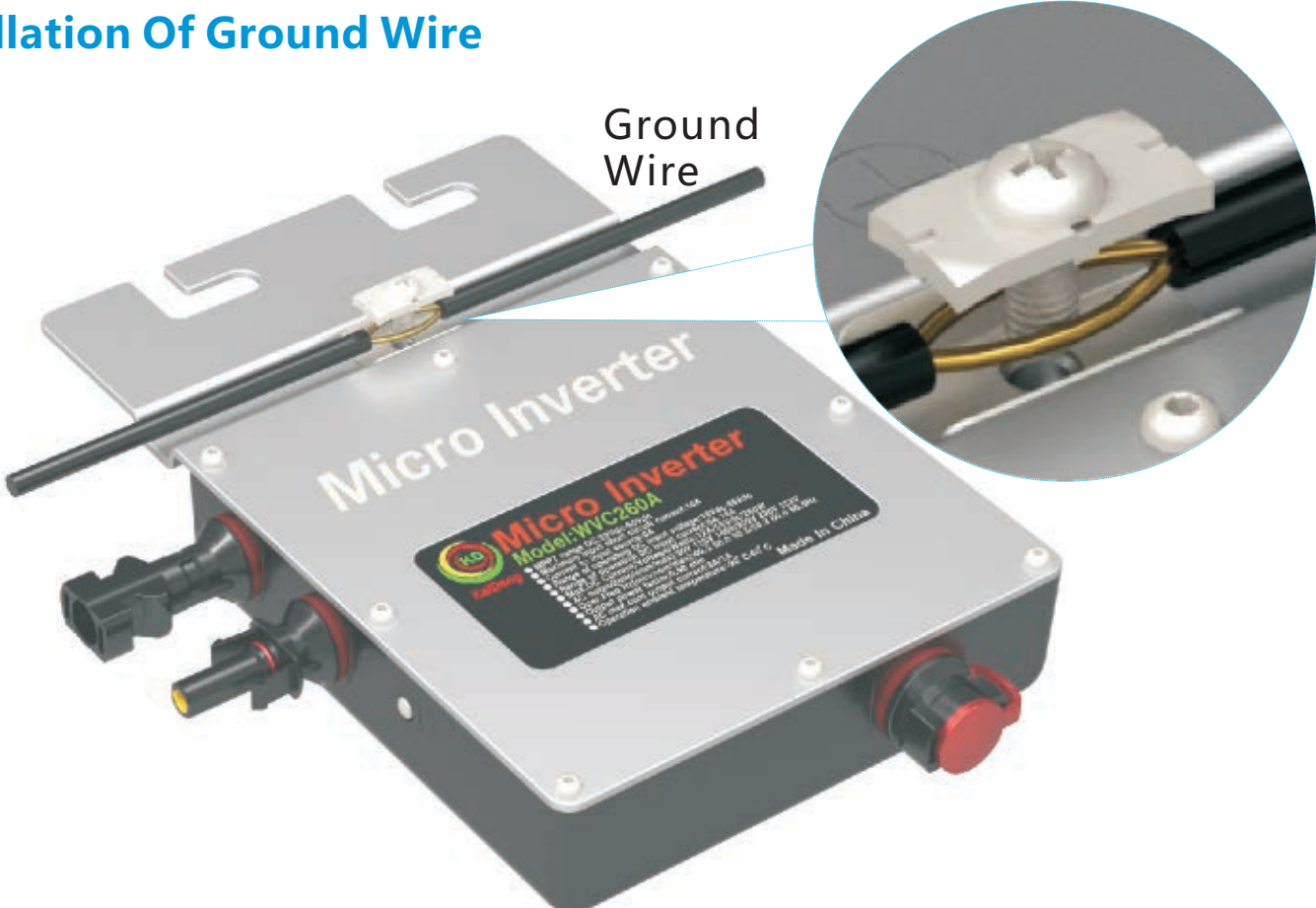

Single-Phase Connection

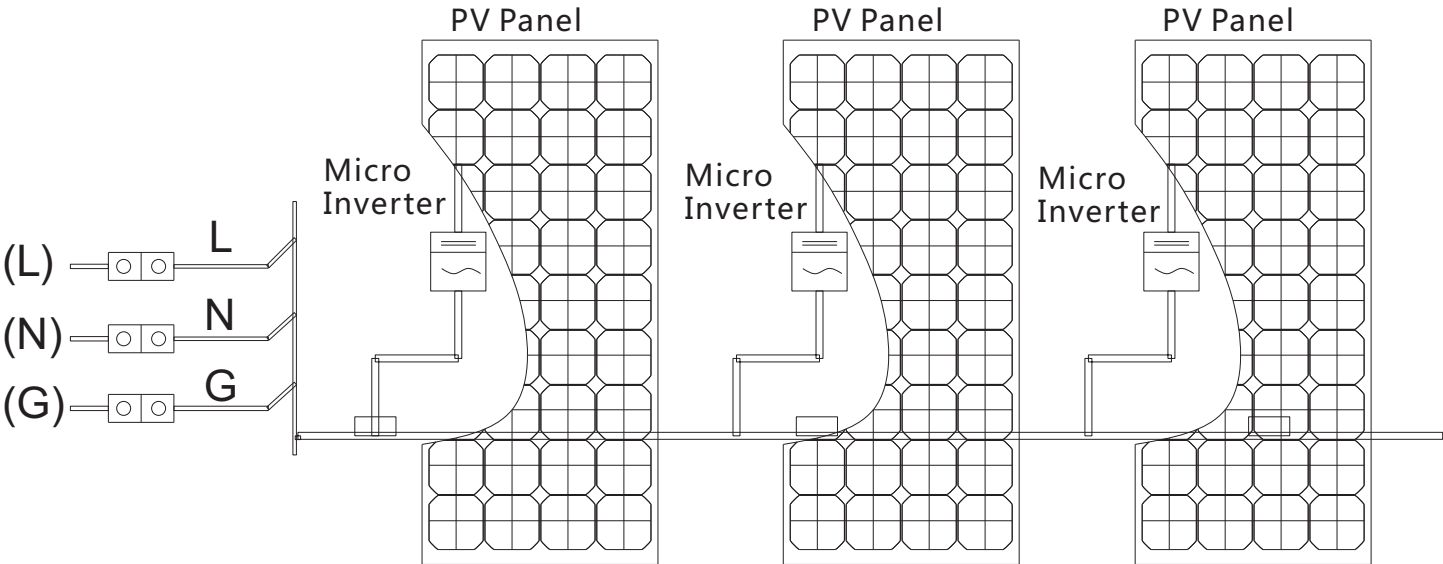

Three-Phase Connection

