



Micro inverter

Smart APP Phone monitoring GTB series instructions



Email: RunLin.info@gmail.com

WhatsApp: +086 13927402025

Wechat: chexin136 janney

Simplicity
from precision machining

USER'S
MANUAL

Product instructions

Thank you for using GTB series micro inverter! GTB series micro inverter has high efficiency MPPT engine, intelligent wifi module, multiple security protection, simple installation, reliable performance, equipped with a new generation of smart home (smart life app) wifi monitoring system to use together, to achieve the Internet of things intelligent online monitoring and control!

(GTB-400 □ GTB-600 □ GTB-800 □ GTB-1200 □ GTB-1600 □)

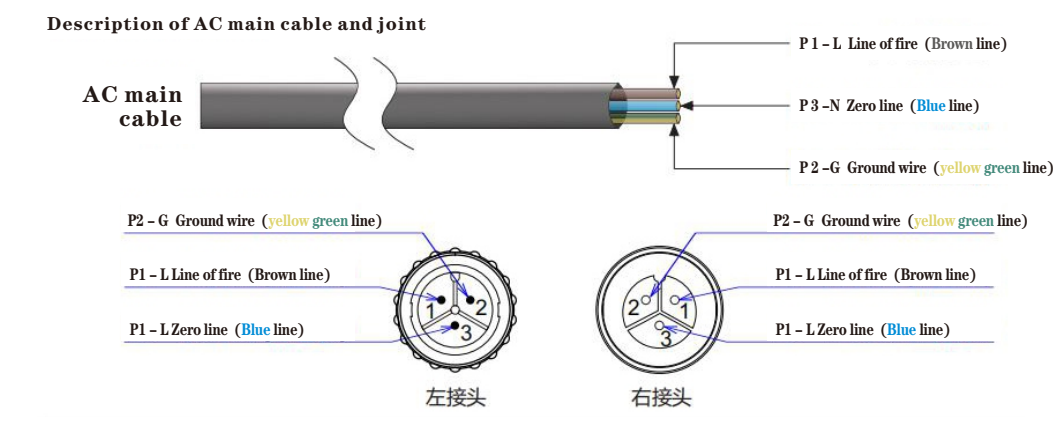
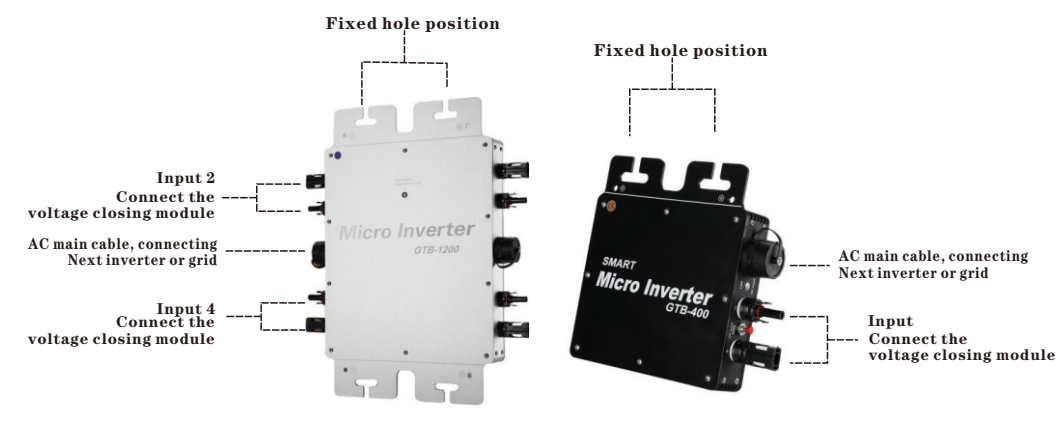

Safety Precautions

The GTB micro inverters are designed with safety requirements according to international standards (IEC 62109-1 / -2, EN61000-3-2, EN61000-3-3, EN50438, VDE4105, VDE 0126, ULL1741, AS4777.1/2, etc.). However, certain safety precautions must be taken during the installation and operation of this equipment. The installation procedure must read and follow all instructions, precautions, and warnings in the installation manual here. For safety reasons, only qualified technicians with training or proven skills should install and maintain.

This micro inverter under the guidance of this document

- Before installation, due to long-distance transportation, please check the integrity of the inverter accessories, whether the shell is damaged, whether the connector leakage, whether the model matches the problem, if there are such problems, please contact the dealer to replace and send accessories.
- Check the surrounding installation environment, micro-inverters should be installed in places with good air flow and avoid direct coverage of rain and snow, such as: the solar panel below, under the eaves or indoors, etc., around the air flow conducive to micro-inverter own heat dissipation.
- Before installation, please plan the length of the inverter AC cable, if you need to extend the cable, please check the color of the wire core and the corresponding wire type (L - Live wire, N - Neutral line, G - Ground).
- The housing of the micro inverter has a ground mark, connect it correctly to the ground wire when installing.
- Inverters cannot be installed to work underwater, they are only IP65 rated.
- The micro-inverter can only be used as an input source for the solar panel connection.
- The micro inverter has 2 indicator lights, the main LED (red \ green) is located at the front housing and will provide information on the operating status of the inverter and the secondary LED (blue) is located at the side DC connector and will provide information on the status of the WiFi signal.
- In order to maintain safety and integrity, do not disassemble the microinverter or make any internal repairs until you have been professionally trained and authorized to do so! Otherwise the manufacturer reserves the right not to provide after-sales service.
- Please make sure that the open-circuit voltage VOC and operating voltage VMP of the PV module are in accordance with the input voltage and operating voltage range of this equipment.
- When the solar panel is connected to the inverter during the installation process, multiple series connection is prohibited for each group of access ports. If the DC voltage input is too high, the machine may burn out.

Micro inverters operate when

- Do not open the micro inverter when working and cut the DC / AC cable to avoid the risk of electric shock!
- Micro inverter is a grid-connected power generation equipment, it must be connected to the grid and the grid can work properly to generate electricity, when the grid power outage, the device will also stop generating electricity.
- When the micro inverter fails, please first disconnect the AC voltage, and then remove the faulty inverter and reconnected.
- Micro inverter to adapt to the operating temperature is (-40 ° C to + 65 ° C), please do not touch the inverter shell directly with your hands to avoid burns. When the temperature of the inverter exceeds a certain value, the inverter will turn on the over-temperature protection function, and when the temperature of the inverter drops, the inverter will be restarted.
- The micro inverter has 2 indicator lights, the main LED is located on the front side of the housing and will provide information about the inverter operating status, the secondary LED is located on the side of the DC connector and will provide information about the status of the WiFi signal.

Parameter table (-300, -350, -400)



Model	GTB-300	GTB-350	GTB-400	
Import(DC)	Recommended solar panel input power (W)	200-300W	250-350W	275-400W
	Number of DC input connections (groups)	MC4*1	MC4*1	MC4*2
	Maximum DC input voltage	52V	52V	52V
	Operating voltage range	20-50V	20-50V	20-50V
	Start-up voltage	18V	18V	18V
	MPPT Tracking Range	22-48V	22-48V	22-48V
	MPPT Tracking accuracy	>99.5%	>99.5%	>99.5%
	Maximum DC input current	12	12	12A*2
	Rated power output	280W	330W	380W
	Maximum output power	300W	350W	400W
	Rated output voltage	120V	120V	230V
	Output voltage range	90-160V	90-160V	190-270V
	Rated AC current (at 120V)	2.5A	2.91A	3.3A
	Rated AC current (at 230V)	1.3A	1.52A	1.73A
	Rated output frequency	50Hz	60Hz	60Hz
	Output frequency range (Hz)	47.5-50.5Hz	58.9-61.9Hz	58.9-61.9Hz
	THD	<5%		
	Power factor	>0.99		
	Maximum number of branch circuit connections	@120VAC : 8 set / @230VAC : 16 set		
	Maximum conversion efficiency	95%	94.50%	94%
	CEC efficiency	92%	92%	92%
	Night losses	<80mW		
	Over/under voltage protection	Yes		
	Over/under frequency protection	Yes		
	Anti-islanding protection	Yes		
	Overcurrent protection	Yes		
	Overload protection	Yes		
	Over-temperature protection	Yes		
	Protection class	IP65		
	Working environment temperature	-40°C ~ +65°C		
	Weight (KG)	1.2KG		
	Indicator lights quantity	Working status LED light *1 + Wifi signal led light *1		
	Communication connection mode	WiFi/2.4G		
	Cooling method	Natural cooling (no fan)		
	Working environment	Indoor and outdoor		
	Certification standards	EN61000-3-2, EN61000-3-3, EN62109-2, EN55032, EN55035, EN50438		

Parameter table (-600, -700, -800)



Model	GTB-600	GTB-700	GTB-800	
Import(DC)	Recommended solar panel input power (W)	200-300W*2	250-350W*2	275-400W*2
	Number of DC input connections (groups)	MC4*2	MC4*2	MC4*2
	Maximum DC input voltage	52V	52V	52V
	Operating voltage range	20-50V	20-50V	20-50V
	Start-up voltage	18V	18V	18V
	MPPT Tracking Range	22-48V	22-48V	22-48V
	MPPT Tracking accuracy	>99.5%	>99.5%	>99.5%
	Maximum DC input current	12A*2	12A*2	12A*2
	Rated power output	550W	650W	750W
	Maximum output power	600W	700W	800W
	Rated output voltage	120V	120V	230V
	Output voltage range	90-160V	90-160V	190-270V
	Rated AC current (at 120V)	5A	5.83A	6.6A
	Rated AC current (at 230V)	2.6A	3A	3.47A
	Rated output frequency	50Hz	60Hz	60Hz
	Output frequency range (Hz)	47.5-50.5Hz	58.9-61.9Hz	58.9-61.9Hz
	THD	<5%		
	Power factor	>0.99		
	Maximum number of branch circuit connections	@120VAC : 5 set / @230VAC : 10 set		
	Maximum conversion efficiency	95%	94.50%	94%
	CEC efficiency	92%	92%	92%
	Night losses	<80mW		
	Over/under voltage protection	Yes		
	Over/under frequency protection	Yes		
	Anti-islanding protection	Yes		
	Overcurrent protection	Yes		
	Overload protection	Yes		
	Over-temperature protection	Yes		
	Protection class	IP65		
	Working environment temperature	-40°C ~ +65°C		
	Weight (KG)	2.5 KG		
	Indicator lights quantity	Working status LED light *1 + Wifi signal led light *1		
	Communication connection mode	WiFi/2.4G		
	Cooling method	Natural cooling (no fan)		
	Working environment	Indoor and outdoor		
	Certification standards	EN61000-3-2, EN61000-3-3, EN62109-2, EN55032, EN55035, EN50438		

Parameter table (-1200, -1400, -1600)



Model	GTB-1200	GTB-1400	GTB-1600	
Import(DC)	Recommended solar panel input power (W)	250-300W*4	300-350W*4	300-400W*4
	Number of DC input connections (groups)	MC4*4	MC4*4	MC4*4
	Maximum DC input voltage	52V	52V	52V
	Operating voltage range	20-50V	20-50V	20-50V
	Start-up voltage	18V	18V	18V
	MPPT Tracking Range	22-48V	22-48V	22-48V
	MPPT Tracking accuracy	>99.5%	>99.5%	>99.5%
	Maximum DC input current	15A*4	15A*4	15A*4
	Rated power output	1150W	1350W	1550W
	Maximum output power	1200W	1400W	1600W
	Rated output voltage	120V	120V	230V
	Output voltage range	90-160V	90-160V	190-270V
	Rated AC current (at 120V)	10A	11.6A	13.3A
	Rated AC current (at 230V)	5.2A	6A	6.9A
	Rated output frequency	50Hz	60Hz	60Hz
	Output frequency range (Hz)	47.5-50.5Hz	58.9-61.9Hz	58.9-61.9Hz
	THD	<5%		
	Power factor	>0.99		
	Maximum number of branch circuit connections	@120VAC : 2 set / @230VAC : 4 set		
	Maximum conversion efficiency	95%	94.50%	94%
	CEC efficiency	92%	92%	92%
	Night losses	<80mW		
	Over/under voltage protection	Yes		
	Over/under frequency protection	Yes		
	Anti-islanding protection	Yes		
	Overcurrent protection	Yes		
	Overload protection	Yes		
	Over-temperature protection	Yes		
	Protection class	IP65		
	Working environment temperature	-40°C ~ +65°C		
	Weight (KG)	3.5 KG		
	Indicator lights quantity	Working status LED light *1 + Wifi signal led light *1		
	Communication connection mode	WiFi/2.4G		
	Cooling method	Natural cooling (no fan)		
	Working environment	Indoor and outdoor		
	Certification standards	EN61000-3-2, EN61000-3-3, EN62109-2, EN55032, EN55035, EN50438		

Wiring

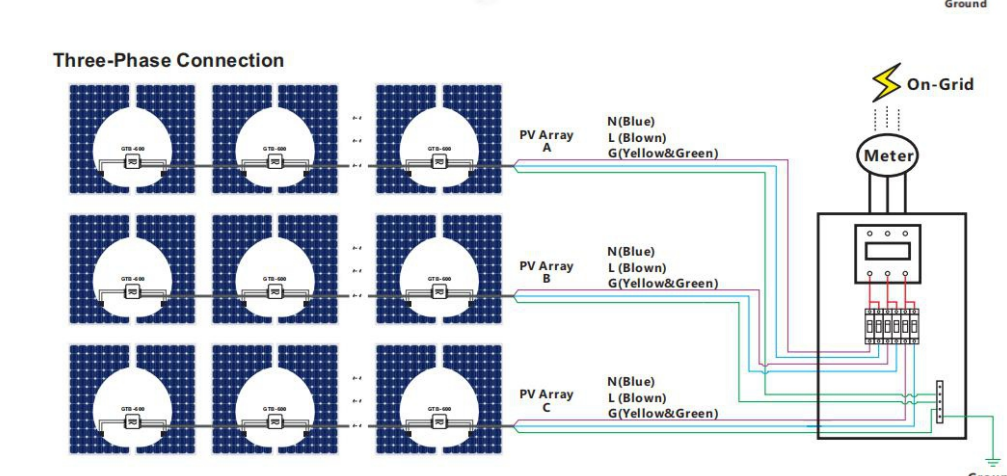
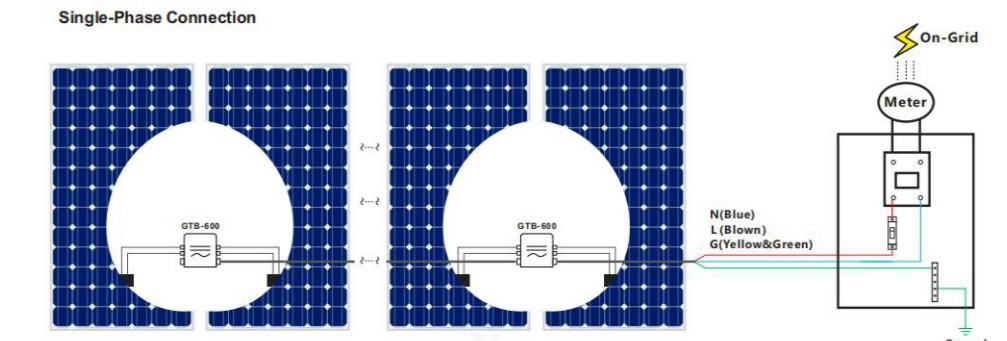
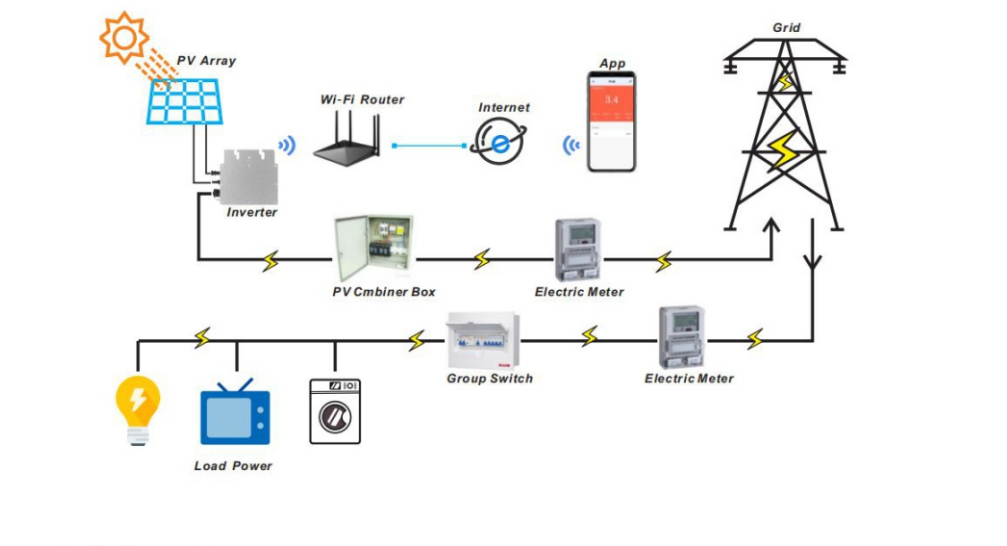

WiFi monitoring connection methods and precautions

When you try to connect the smart app mobile phone monitoring, please check whether the model you choose supports WiFi communication function. The factory machine does not support communication by default

- Scan QR code to download app - (Smart Life), or download 'Smart Life' in mobile app mall and install app of monitoring system (support Android and IOS system and multi language);
- Click create user registration and login
- Add a device, select the WiFi button
- When prompted, enter the name and password of the home WiFi network you want to connect to
- When waiting, please check the blue LED flashing on the side of the inverter. WiFi signal is in the process of connection. The blue LED needs to flash quickly. After the connection is successful, the blue LED light stops flashing and is always on. It takes about 10-60 seconds, depending on the WiFi signal strength on site.
- After the connection is successful, you can control the device on / off and view the real-time data of the device through the app.

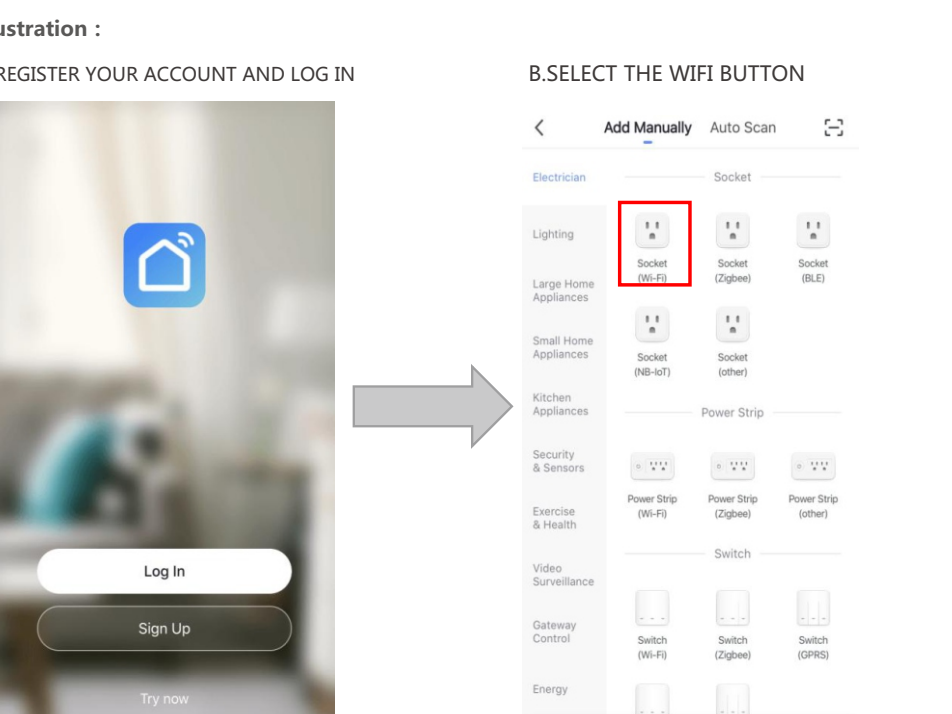

ENTER THE WIFI ACCOUNT AND PASSWORD YOU WANT TO CONNECT TO

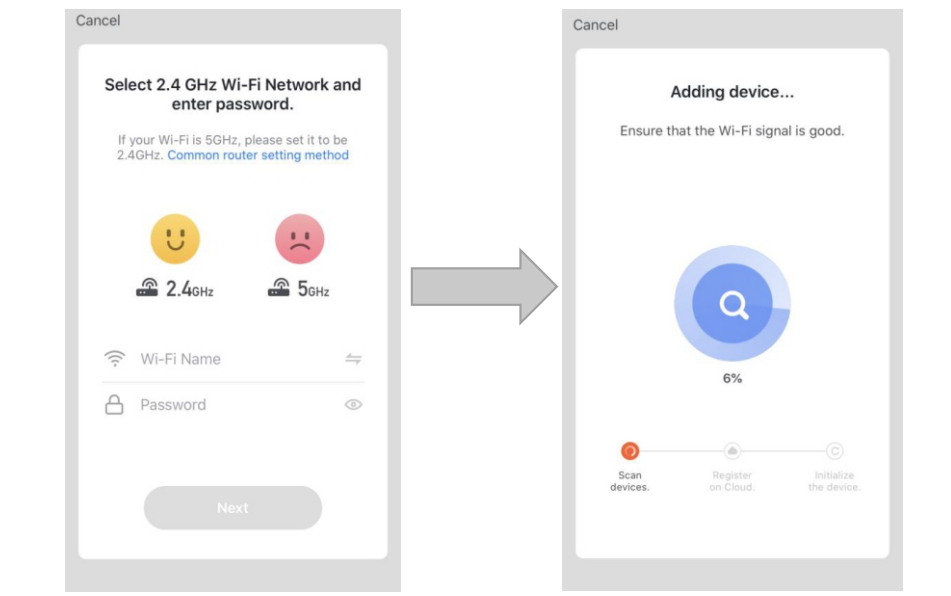

E.THE CONNECTION WAS SUCCESSFUL

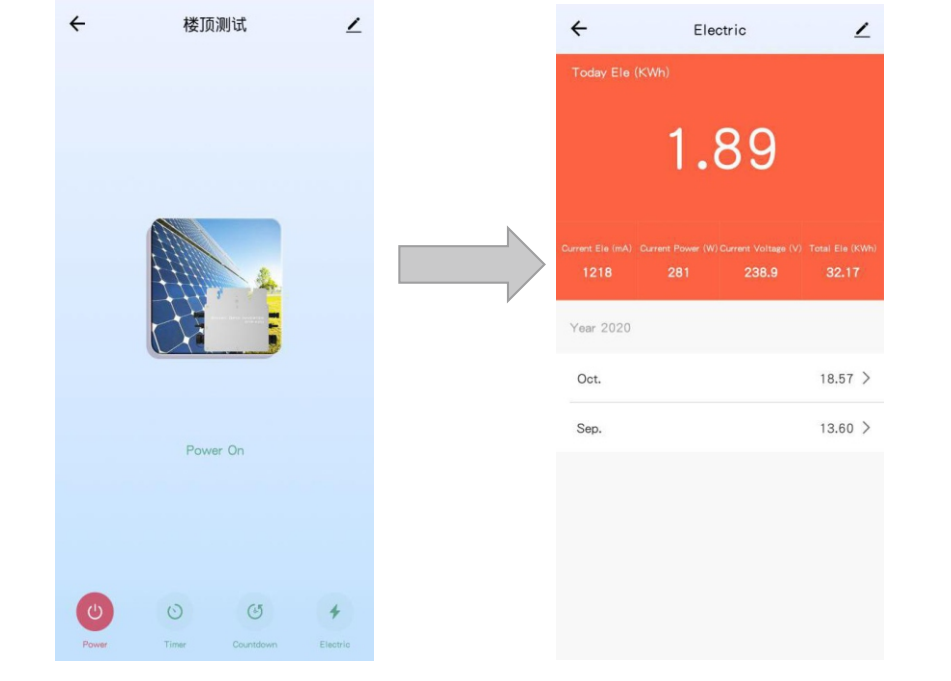

Product Warranty Card

Thank you very much for using our products and services

Model: _____

Serial No. _____

Date of manufacture: _____

Customer Name: _____

Tel. _____

Address: _____

E-Mail: _____

Remarks: _____

Purchase Date: _____ Invoice No. _____

Simplicity
Simplicity from precision machining