

# GFM-1000

## VRLA Battery (2V1000Ah)

### Features

- VRLA battery uses corrosion resistant high-tin alloy grids to enhance corrosion resistance of plates, effectively improve the life of float charging.
- High-tight assembly process design and assorted equipments greatly improved batteries charging acceptance and deep discharging recovery performance.
- Precise acid vacuum injection method, advanced, environmental formation technology, which effectively guarantee the consistency of the batteries
- The terminal adopts proprietary technology of sealing structure and high-temperature curing epoxy adhesive to ensure batteries safety and reliability

### Dimensions

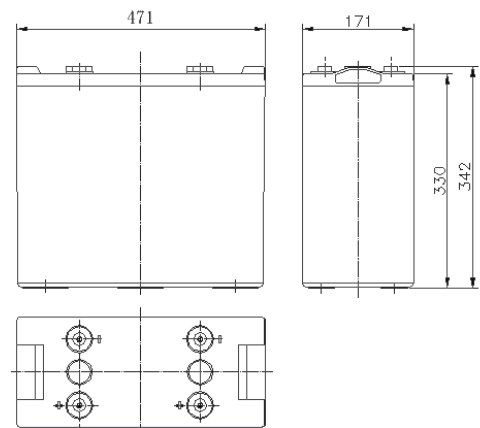

### Specifications

Battery Type	VRLA Battery
Nominal Voltage	2V
Nominal Capacity	1000Ah (10hr, 1.8V, 25°C)
Dimension(L*W*H)	471(mm)*171(mm)*342(mm)
Designed Life(Float charge, 25°C)	8 Years
The reference weight	62.83kg
Operation Ambient Temperature	-25°C~50°C
Optimal Ambient Temperature	20°C~25°C
Self-discharge Residual Capacity	After 90days storage at 25°C, the residual capacity≥90%
Container Material	ABS
Terminal(mm)	Φ20, M8
The Reference Dimension for Installation(See Pic, L*W*H)	48V: 1195×1052×1053mm



Follow us



# TECHNICAL GRAPHS

## DISCHARGE CHARACTERISTIC CURVE

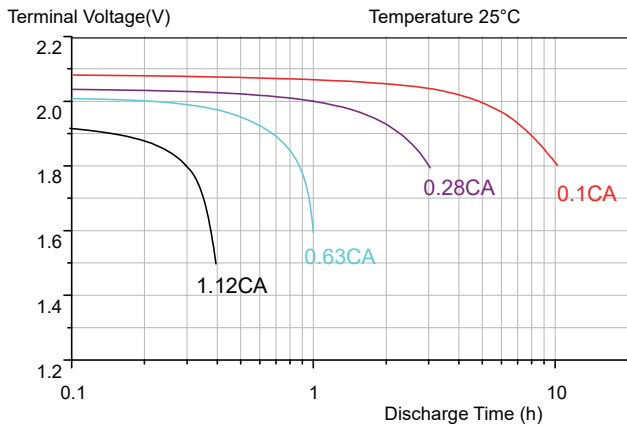

## Temperature Vs. Capacity

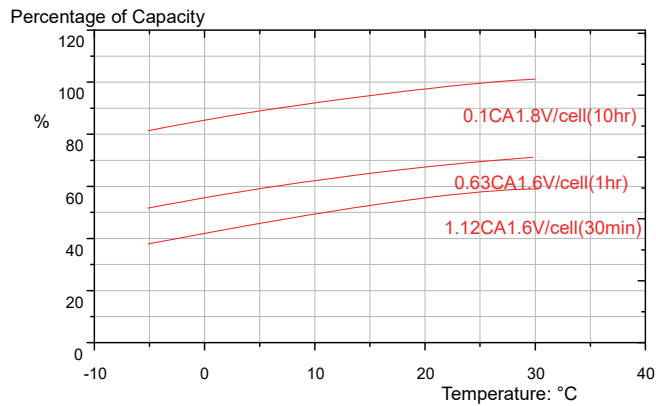

## Self-discharge Characteristics

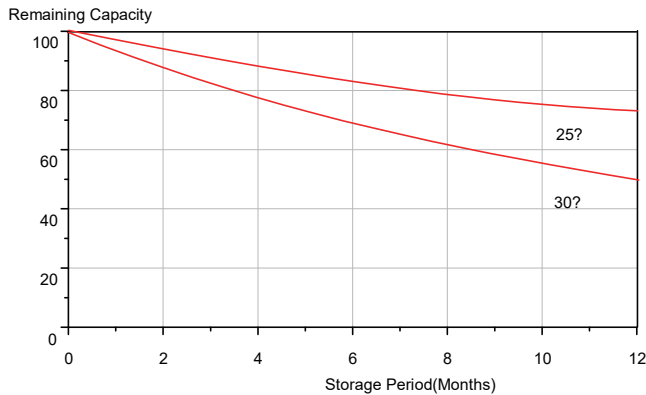

## Discharge Current and Discharge Final Voltage

Discharge Current	0.1C	0.16C	0.23C	0.6C	3C
Final Voltage(V)	1.80	1.75	1.70	1.60	1.30

## CHARGE CHARACTERISTIC CURVE

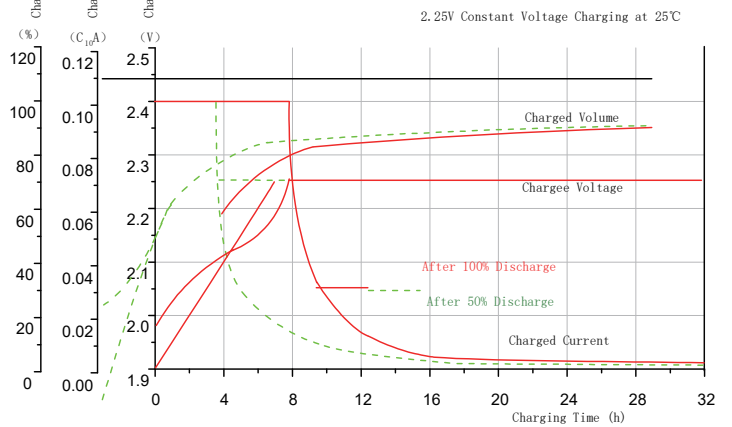

## Accelerated Life Characteristic

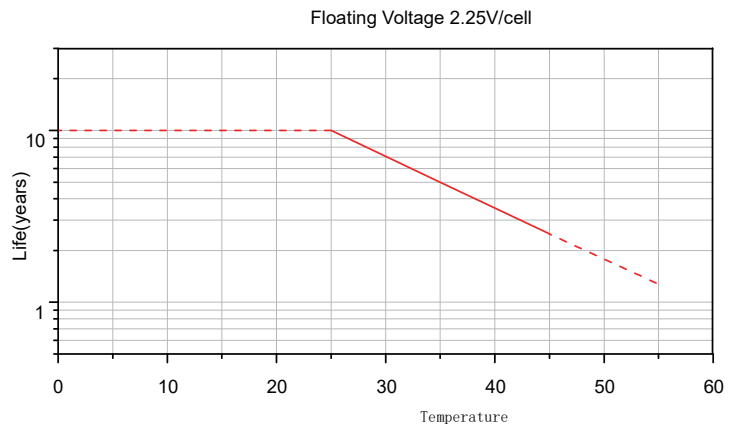

## 48V System Battery Set

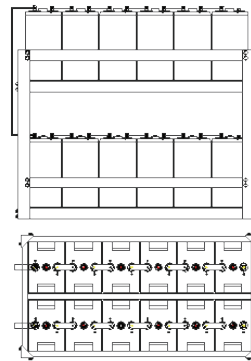

## 48V Horizontal Battery Set

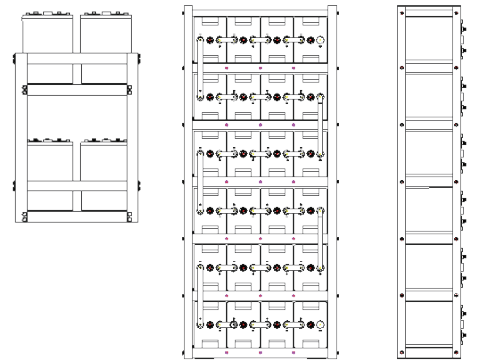

## Charge Method

Type	Voltage(V)	Temperature compensation coefficient	Charge Current(A)
Cycle Charge	2.30~2.40	-4mV/°C	0.1C~0.25C
Float Charge	2.23~2.27	-3mV/°C	

Follow us

