

**Specifications**

Nominal Voltage		12 V
Capacity (25°C)	10HR(10.8V)	110 Ah
	5HR(10.5V)	96Ah
	1HR(9.60V)	68Ah
Dimension	Length	395 ± 2mm (15.55inch)
	Width	110 ± 2mm (4.33inch)
	Height	286 ± 2mm (11.26inch)
	Total Height	286 ± 2mm (11.26inch)
Approx. Weight		32.5kg (71.7lbs) ± 4%
Terminal type		T9
Internal resistance (Fully charged, 25°C)		Approx. 5m Ω
Capacity affected by temperature (10HR)	40°C	102%
	25°C	100%
	0°C	85%
	-15°C	65%
Self-discharge (25°C)	3 month	Remaining Capacity: 91%
	6 month	Remaining Capacity: 82%
	12 month	Remaining Capacity: 65%
Nominal operating temperature		25°C ± 3°C (77°F ± 5°F)
Operating temperature range	Discharge	-15°C ~ 50°C (5°F ~ 122°F)
	Charge	-10°C ~ 50°C (14°F ~ 122°F)
	Storage	-20°C ~ 50°C (-4°F ~ 122°F)
Float charging voltage(25°C)		13.50 to 13.80V Temperature compensation: -18mV/°C
Cyclic charging voltage(25°C)		14.50 to 14.90V Temperature compensation: -30mV/°C
Maximum charging current		33A
Terminal material		Copper
Maximum discharge current		800A(5 sec.)
Designed floating life(20°C)		15 years

- ◆ Absorbent glass mat technology;
- ◆ Recognized by UL & CE;
- ◆ ABS container.

**Constant Current Discharge Characteristics (A, 25°C)**

F.V/TIME	15min	30min	60min	2h	3h	4h	5h	6h	8h	10h	20h
9.60V	178	108	68.2	40.2	28.1	23.0	19.6	17.2	13.5	11.2	5.88
9.90V	174	106	67.2	40.0	27.9	22.9	19.5	17.1	13.4	11.2	5.87
10.2V	167	102	65.5	39.6	27.7	22.7	19.4	16.9	13.3	11.1	5.85
10.5V	162	99.9	64.2	39.0	27.5	22.6	19.3	16.8	13.2	11.1	5.82
10.8V	153	96.3	62.2	38.0	26.7	21.9	18.7	16.3	12.8	11.0	5.78

**Constant Power Discharge Characteristics (Watt, 25°C)**

F.V/TIME	15min	30min	60min	2h	3h	4h	5h	6h	8h	10h	20h
9.60V	1953	1210	777	465	330	270	232	203	160	134	70.5
9.90V	1906	1185	766	463	328	269	231	202	159	133	70.4
10.2V	1836	1149	746	459	326	267	229	200	158	133	70.2
10.5V	1773	1121	732	452	323	265	228	199	157	132	69.8
10.8V	1680	1080	709	440	314	257	221	193	152	131	69.3

Note: The above characteristics data can be obtained within three charge/discharge cycles.

**Dimensions**

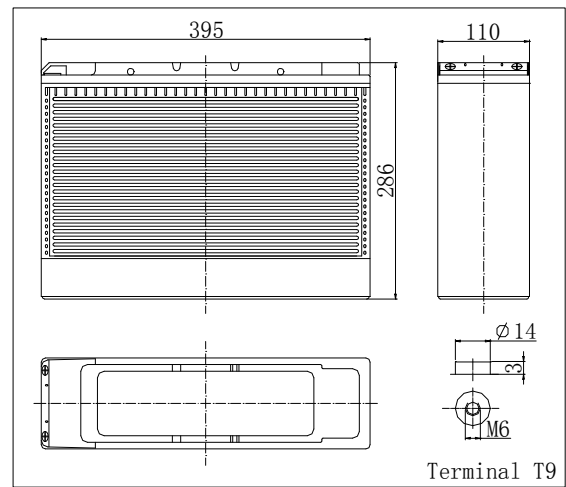

**Terminal**

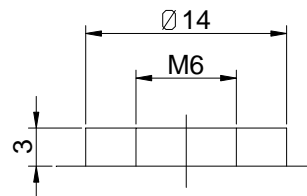

Terminal T9

Discharge Characteristics(25°C)

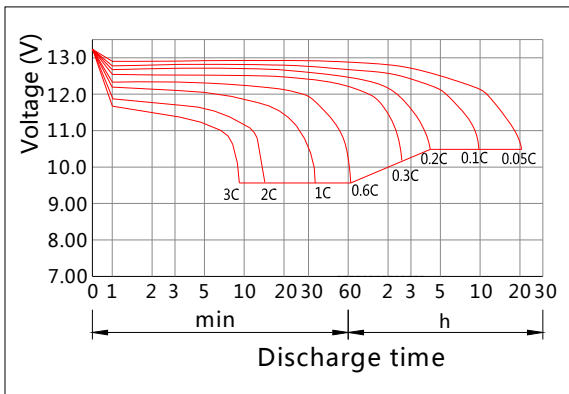

Charging Characteristics(25°C)

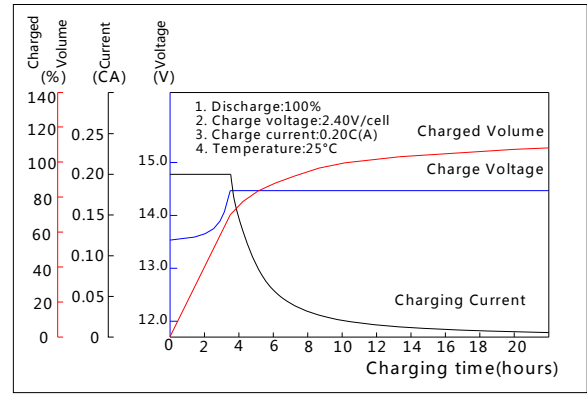

Effect of Temperature on Capacity

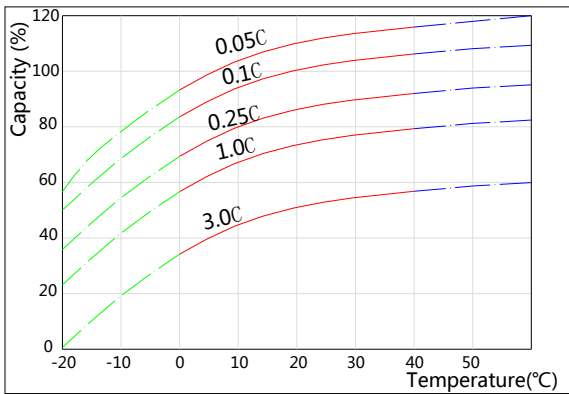

Self-discharge Characteristics

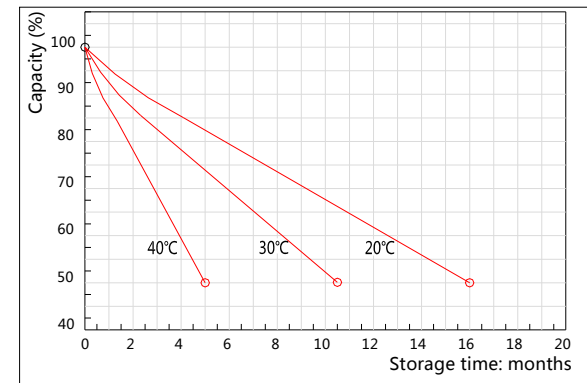

The Relationship for Open Circuit Voltage and Residual Capacity (25°C)

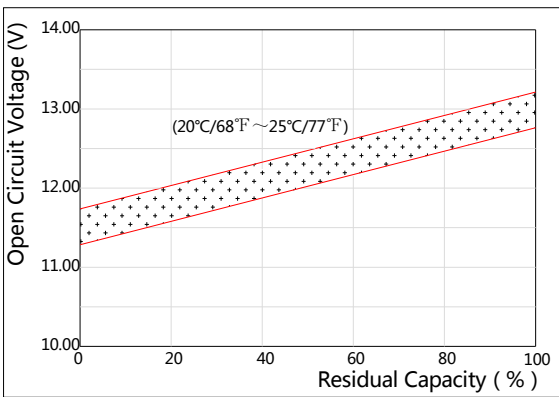

The Relationship for Charging Voltage and Temperature

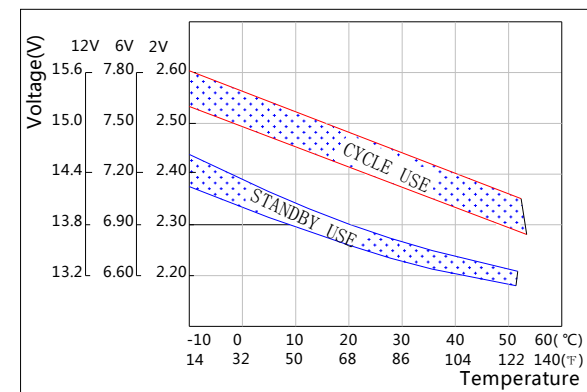

Floating Life on Temperature

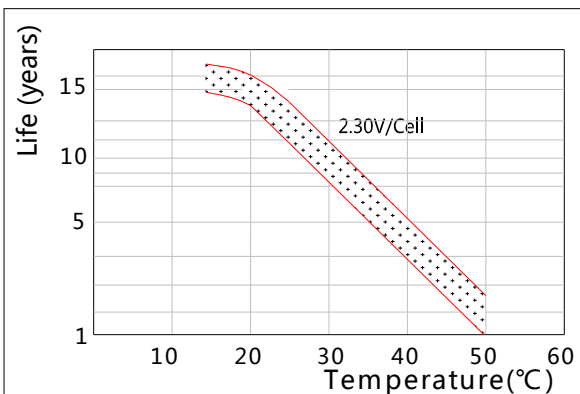

Cycle Life on D.O.D(25°C)

