

Specifications

Nominal Voltage		12 V
Capacity (25°C)	10HR(10.8V)	200 Ah
	5HR(10.5V)	175Ah
	1HR(9.60V)	124Ah
Dimension	Length	546 ± 3mm (21.50inch)
	Width	125 ± 2mm (4.92inch)
	Height	317 ± 2mm (12.48inch)
	Total Height	323 ± 2mm (12.72inch)
Approx. Weight		59kg (130lbs) ± 4%
Terminal type		T11
Internal resistance (Fully charged, 25°C)		Approx. 3.2m Ω
Capacity affected by temperature (10HR)	40°C	102%
	25°C	100%
	0°C	85%
	-15°C	65%
Self-discharge (25°C)	3 month	Remaining Capacity: 91%
	6 month	Remaining Capacity: 82%
	12 month	Remaining Capacity: 65%
Nominal operating temperature		25°C ± 3°C (77°F ± 5°F)
Operating temperature range	Discharge	-15°C ~ 50°C (5°F ~ 122°F)
	Charge	-10°C ~ 50°C (14°F ~ 122°F)
	Storage	-20°C ~ 50°C (-4°F ~ 122°F)
Float charging voltage(25°C)		13.50 to 13.80V Temperature compensation: -18mV/°C
Cyclic charging voltage(25°C)		14.50 to 14.90V Temperature compensation: -30mV/°C
Maximum charging current		60A
Terminal material		Copper
Maximum discharge current		1300A(5 sec.)
Designed floating life(20°C)		15 years

- ◆ Absorbent glass mat technology;
- ◆ Recognized by UL & CE;
- ◆ ABS container.

Dimensions

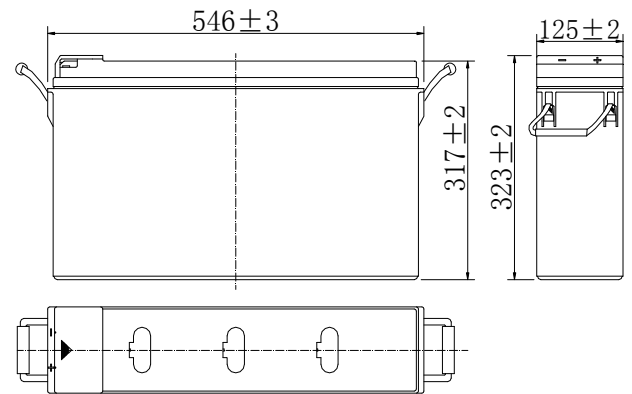

Terminal

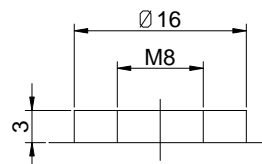

Terminal T11

Constant Current Discharge Characteristics (A, 25°C)

F.V/TIME	5min	10min	15min	30min	60min	2h	3h	4h	5h	6h	8h	10h	20h
9.60V	630	420	330	196	124	73.1	51.0	41.8	35.7	31.2	24.4	20.3	10.7
9.90V	611	408	322	192	122	72.7	50.7	41.6	35.4	31.0	24.3	20.3	10.7
10.2V	586	391	310	187	119	72.0	50.3	41.3	35.2	30.8	24.2	20.2	10.6
10.5V	561	373	300	182	117	70.9	50.0	41.0	35.0	30.6	24.0	20.1	10.6
10.8V	529	353	284	176	113	69.1	48.6	39.8	34.0	29.7	23.3	20.0	10.5

Constant Power Discharge Characteristics (Watt, 25°C)

F.V/TIME	5min	10min	15min	30min	60min	2h	3h	4h	5h	6h	8h	10h	20h
9.60V	6616	4536	3623	2199	1413	847	600	492	422	369	291	243	128
9.90V	6417	4400	3537	2156	1392	841	597	489	420	367	289	242	128
10.2V	6152	4219	3406	2089	1357	833	592	486	417	364	287	242	128
10.5V	5888	4037	3290	2039	1330	821	588	482	413	362	286	240	127
10.8V	5557	3810	3117	1963	1289	800	570	468	401	351	277	239	126

Note: The above characteristics data can be obtained within three charge/discharge cycles.

Discharge Characteristics(25°C)

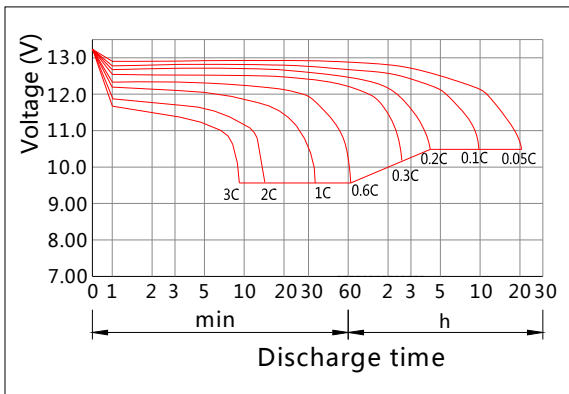

Charging Characteristics(25°C)

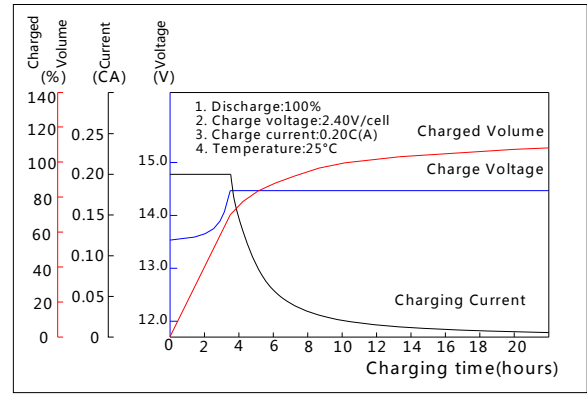

Effect of Temperature on Capacity

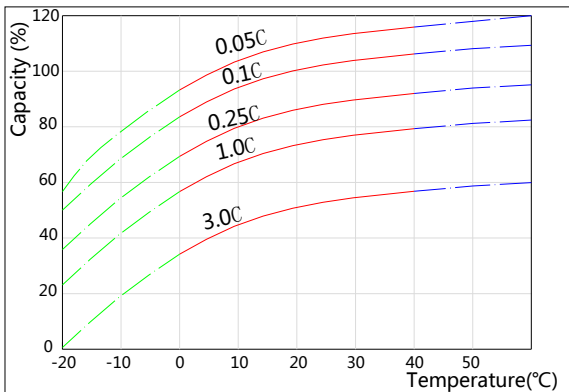

Self-discharge Characteristics

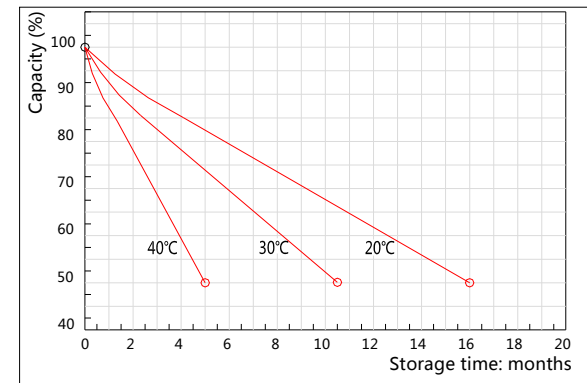

The Relationship for Open Circuit Voltage and Residual Capacity (25°C)

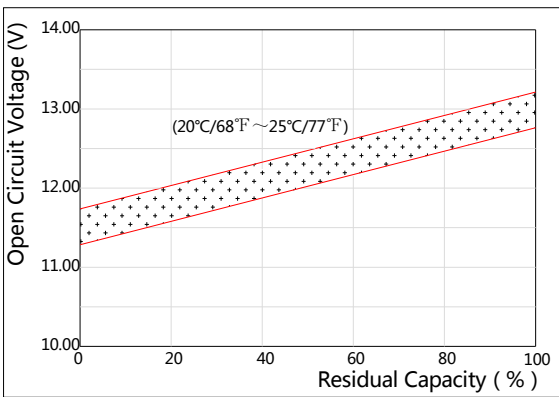

The Relationship for Charging Voltage and Temperature

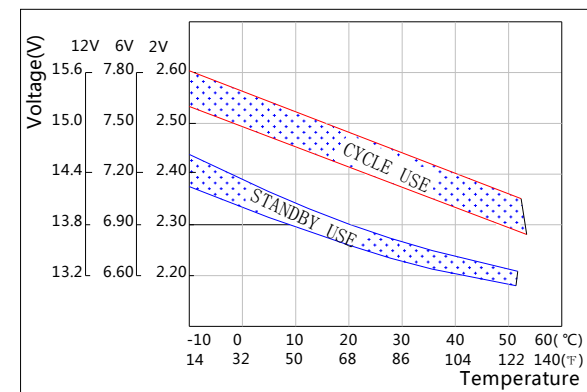

Floating Life on Temperature

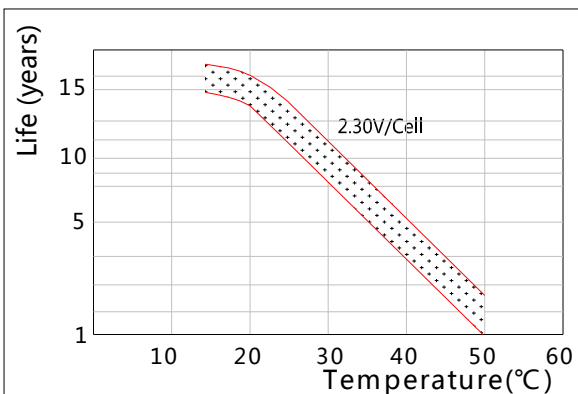

Cycle Life on D.O.D(25°C)

