



UNL100-2 (2V100Ah/10hr)

The rechargeable batteries are lead-lead dioxide systems. The dilute sulfuric acid electrolyte is absorbed by separators and thus immobilized.

Should the battery be accidentally overcharged producing hydrogen and oxygen, Special one-way valves allow the gases to escape thus avoiding excessive pressure build-up. Otherwise, the battery is completely sealed and is, therefore, maintenance-free, leak proof and usable in any position.

Battery Construction

Component	Positive plate	Negative plate	Container	Cover	Safety valve	Terminal	Separator	Electrolyte
Raw material	Lead dioxide	Lead	ABS	ABS	Rubber	Copper	Fiberglass	Sulfuric acid

General Feature

- Absorbent Glass Mat(AGM) technology for efficient gas recombination of up to 99% and freedom from electrolyte maintenance or water adding.
- Not restricted for air transport-complies with IATA/ICAO Special Provision A67.
- UL-recognized component.
- Can be mounted in any orientation.
- Computer designed lead, calcium tin alloy grid for high power density.
- Long service life, float or cyclic applications.
- Maintenance-free operation.
- Low self discharge.

SPECIFICATION

Nominal voltage 2V
 Number of cell 1
 Length(mm/inch) 171/6.73
 Width(mm/inch) 72/2.83
 Height(mm/inch) 206/8.11
 Total Height(mm/inch) 211/8.31
 Approx. Weight(kg/lbs) 6.0/13.2

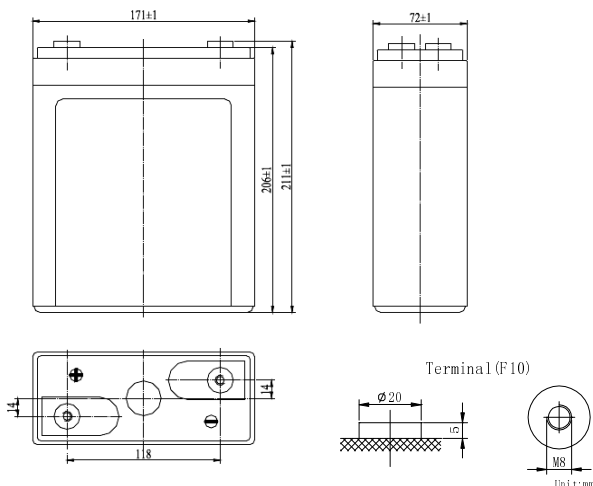

Performance Characteristics

Capacity 77°F(25°C)	10 hour rate (10A、1.80V)	100Ah
	5 hour rate (17.6A、1.75V)	88Ah
	3 hour rate (25.8A、1.70V)	77.4Ah
	1 hour rate (65A、1.60V)	65Ah
Internal Resistance	Full charged Battery77°F(25°C): 1mΩ	
Capacity affected by Temperature (10 hour rate)	104° F(40°C)	102%
	77° F(25°C)	100%
	32° F(10°C)	85%
	5° F(-15°C)	65%
Self-Discharge 68°F(20°C)	Capacity after 3 month storage	90%
	Capacity after 6 month storage	80%
	Capacity after 12month storage	60%
Max. discharge current77°F(25°C): 500A(5S)		
Charge (Constant Voltage)	Float: 2.25~2.30 V/77° F(25°C)	
	Cycle:2.35~2.45 V/77°F(25°C) Max. Current: 20A	

Discharge Constant Current (Amperes at 77° F25 °C)

End Point Volts/Cell	5min	10min	15min	30min	45min	1h	3h	5h	10h
1.60V		196	146	98.0	81.0	65.0	27.5	19.3	10.8
1.65V		186	140	94.0	78.0	62.5	26.5	18.8	10.6
1.70V		175	132	90.0	74.0	60.0	25.8	18.2	10.4
1.75V		164	125	85.0	71.0	57.0	24.7	17.6	10.2
1.80V		152	118	80.5	67.0	54.0	23.6	17.1	10.0

Discharge Constant Power (watts at 77° F 25 °C)

End Point Volts/Cell	5min	10min	15min	30min	45min	1h	2h	3h	5h
1.60V		285	256	197	147	122	73.0	53.5	39.3
1.65V		269	242	187	140	117	71.0	52.2	38.6
1.70V		251	228	177	133	112	69.0	50.8	37.8
1.75V		233	213	165	126	105	66.0	49.2	37.0
1.80V		218	200	156	119	100	63.0	47.6	36.1

(Note)The above characteristics data are average values obtained Within three charge/discharge cycles not the minimum values.

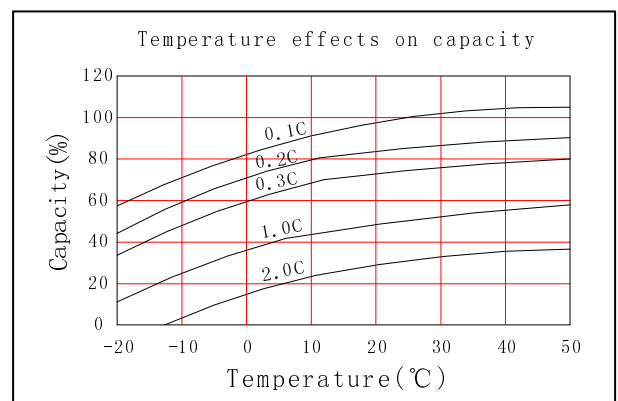
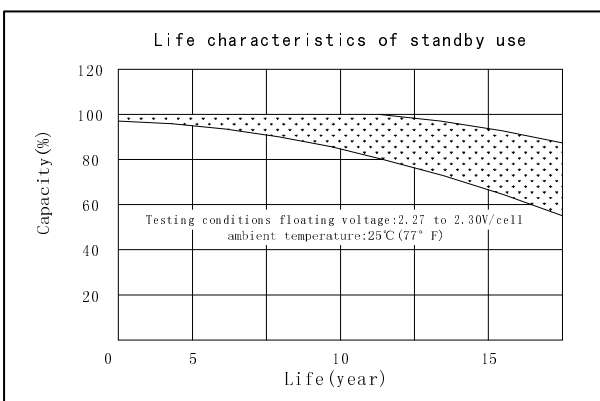
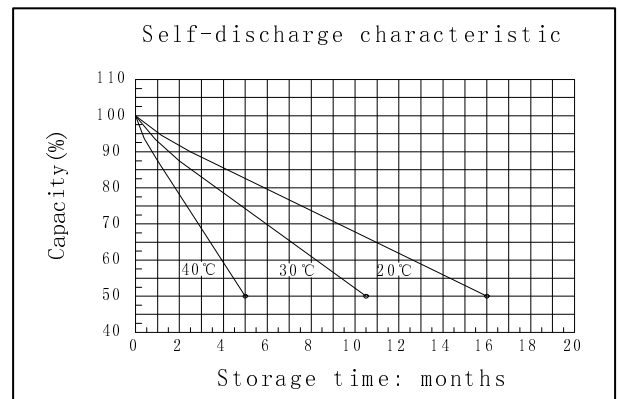
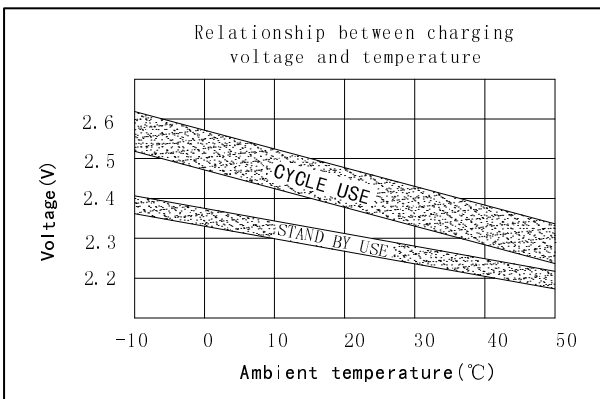
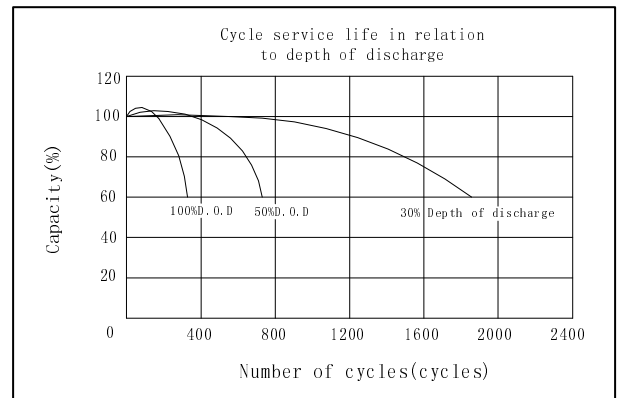
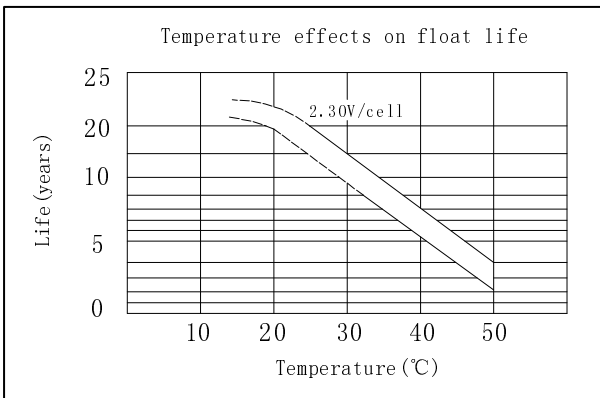
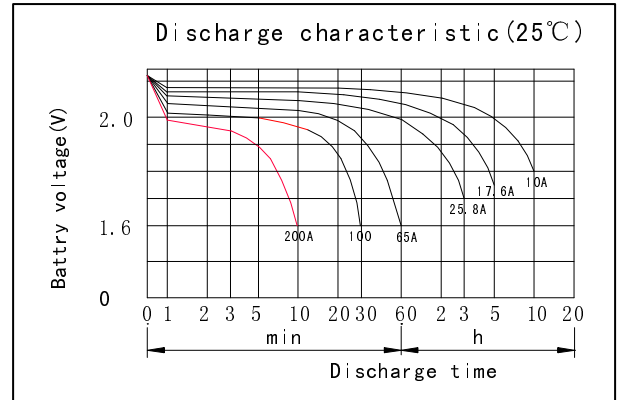
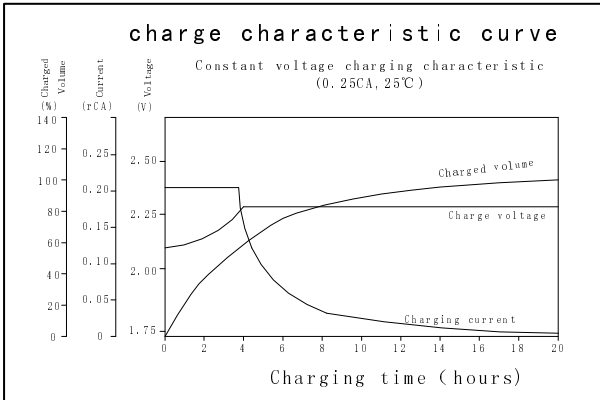

DONGGUAN OREMA POWER CO., LTD

Add: #1 Qilinling Road Shahu, Tangxia Town, Dongguan Guangdong China

TEL: +86-769- 3896 1163 +86-769- 3896 1168

FAX: +86-769- 3896 1169



www.oremabattery.com