



UNL250-2 (2V250Ah/10hr)

The rechargeable batteries are lead-lead dioxide systems. The dilute sulfuric acid electrolyte is absorbed by separators and thus immobilized.

Should the battery be accidentally overcharged producing hydrogen and oxygen, Special one-way valves allow the gases to escape thus avoiding excessive pressure build-up. Otherwise, the battery is completely sealed and is, therefore, maintenance-free, leak proof and usable in any position.

Battery Construction

Component	Positive plate	Negative plate	Container	Cover	Safety valve	Terminal	Separator	Electrolyte
Raw material	Lead dioxide	Lead	ABS	ABS	Rubber	Copper	Fiberglass	Sulfuric acid

General Feature

- Absorbent Glass Mat(AGM) technology for efficient gas recombination of up to 99% and freedom from electrolyte maintenance or water adding.
- Not restricted for air transport-complies with IATA/ICAO Special Provision A67.
- UL-recognized component.
- Can be mounted in any orientation.
- Computer designed lead, calcium tin alloy grid for high power density.
- Long service life, float or cyclic applications.
- Maintenance-free operation.
- Low self discharge.

SPECIFICATION

Nominal voltage 2V
 Number of cell 1
 Length(mm/inch) 173/6.81
 Width(mm/inch) 111/4.37
 Height(mm/inch) 330/13.0
 Total Height(mm/inch) 364/14.3
 Approx. Weight(kg/lbs) 15.5/34.2

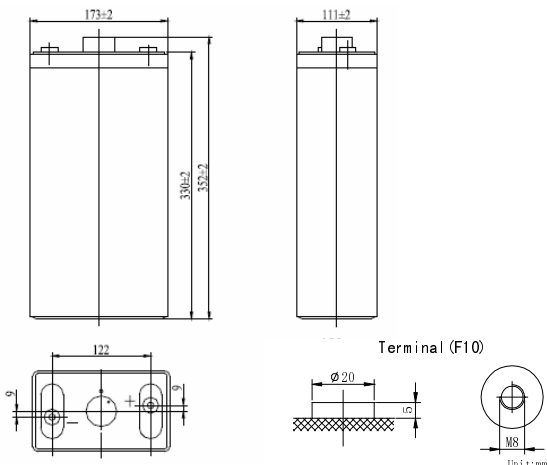

Total height with removable cover:364

Performance Characteristics

Capacity 77°F(25°C)	10 hour rate (25A、1.80V)	250Ah
	5 hour rate (43A、1.75V)	215Ah
	3 hour rate (63A、1.70V)	189Ah
	1 hour rate (153A、1.60V)	153Ah
Internal Resistance	Full charged Battery77°F(25°C): 1mΩ	
Capacity affected by Temperature (10 hour rate)	104° F(40°C)	102%
	77° F(25°C)	100%
	32° F(10°C)	85%
	5° F(-15°C)	65%
Self-Discharge 68°F(20°C)	Capacity after 3 month storage	90%
	Capacity after 6 month storage	80%
	Capacity after 12month storage	60%
Max. discharge current77°F(25°C): 1000A(5S)		
Charge (Constant Voltage)	Float: 2.25~2.30 V/77° F(25°C)	
	Cycle:2.35~2.45 V/77°F(25°C) Max. Current: 50A	

Discharge Constant Current (Amperes at 77°F 25 °C)

End Point Volts/Cell	5min	10min	15min	30min	45min	1h	3h	5h	10h
1.60V		487	367	250	202	153	66.5	45.3	26.4
1.65V		462	350	242	194	148	64.8	44.6	26.1
1.70V		435	331	233	185	143	63.0	43.8	25.8
1.75V		409	312	222	176	138	61.2	43.0	25.4
1.80V		381	293	210	167	132	59.0	42.0	25.0

Discharge Constant Power (watts at 77° F 25 °C)

End Point Volts/Cell	5min	10min	15min	30min	45min	1h	2h	3h	5h
1.60V		725	655	475	385	306	183	133	97.5
1.65V		699	624	455	374	294	178	130	95.8
1.70V		673	591	435	361	280	171	126	93.9
1.75V		646	558	414	350	266	165	123	91.9
1.80V		619	525	394	340	251	158	118	89.6

(Note)The above characteristics data are average values obtained Within three charge/discharge cycles not the minimum values.

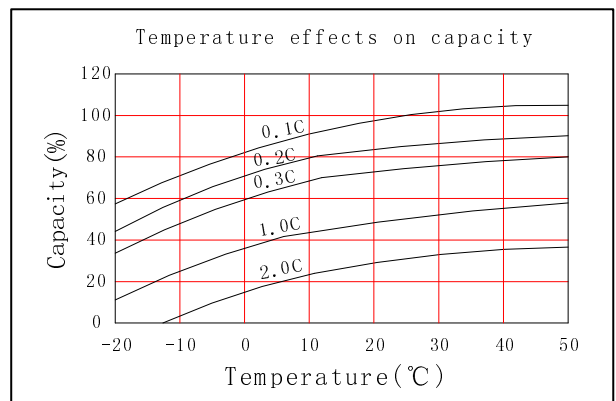
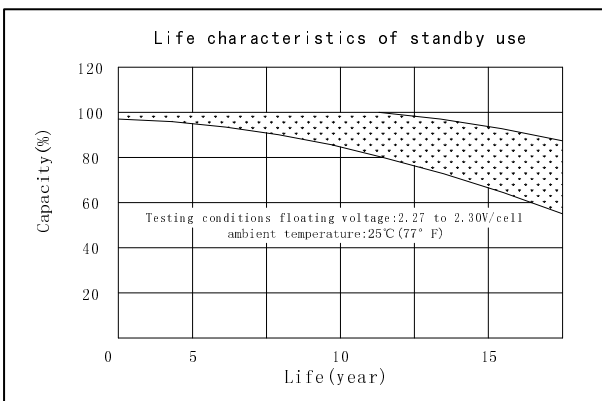
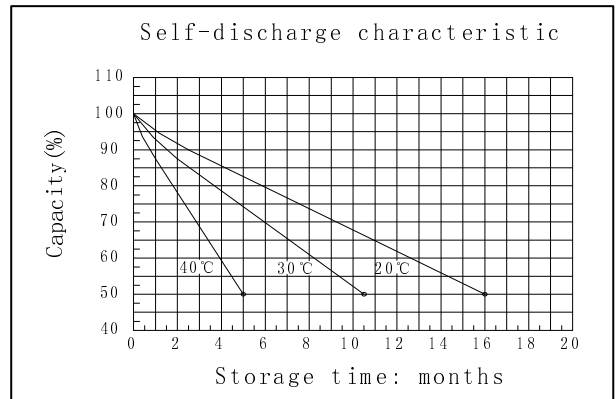
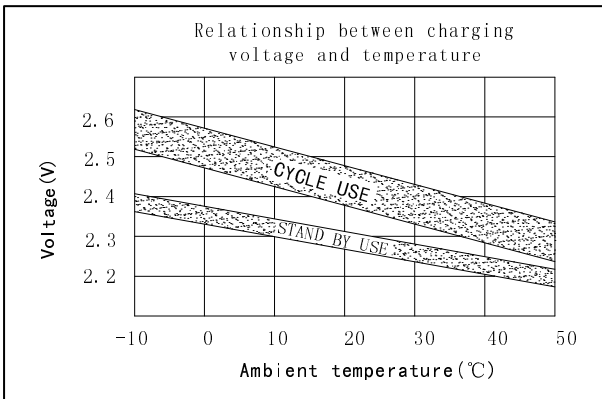
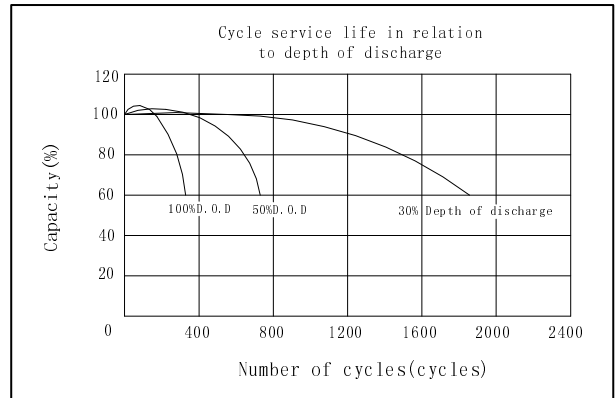
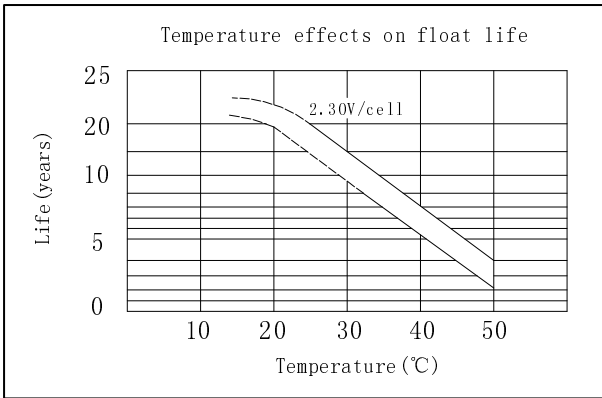
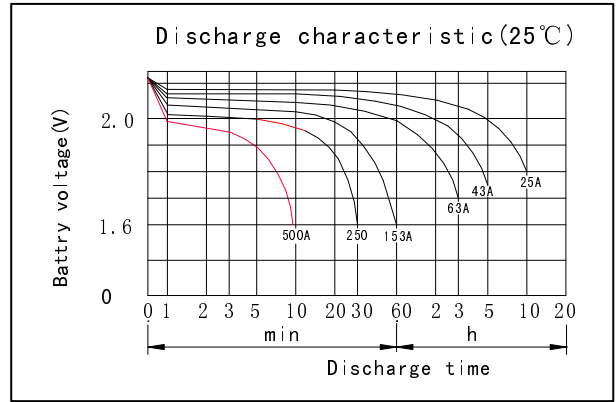
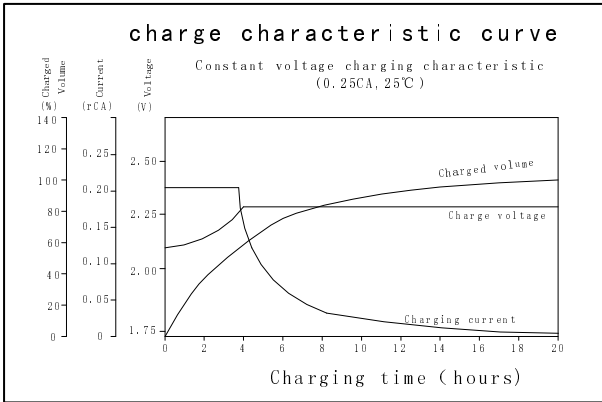

DONGGUAN OREMA POWER CO., LTD

Add: #1 Qilinling Road Shahu, Tangxia Town, Dongguan Guangdong China

TEL: +86-769- 3896 1163 +86-769- 3896 1168

FAX: +86-769- 3896 1169



www.oremabattery.com