



UN220-6D (6V220Ah/20hr)

The rechargeable batteries are lead-lead dioxide systems. The dilute sulfuric acid electrolyte is absorbed by separators and thus immobilized.

Should the battery be accidentally overcharged producing hydrogen and oxygen, Special one-way valves allow the gases to escape thus avoiding excessive pressure build-up. Otherwise, the battery is completely sealed and is, therefore, maintenance-free, leak proof and usable in any position.

Battery Construction

Component	Positive plate	Negative plate	Container	Cover	Safety valve	Terminal	Separator	Electrolyte
Raw material	Lead dioxide	Lead	ABS	ABS	Rubber	Copper	Fiberglass	Sulfuric acid

General Feature

- Absorbent Glass Mat(AGM) technology for efficient gas recombination of up to 99% and freedom from electrolyte maintenance or water adding.
- Not restricted for air transport-complies with IATA/ICAO Special Provision A67.
- UL-recognized component.
- Can be mounted in any orientation.
- Computer designed lead, calcium tin alloy grid for high power density.
- Long service life, float or cyclic applications.
- Maintenance-free operation.
- Low self discharge.

Performance Characteristics

Capacity 77°F(25°C)	20 hour rate (11.0A、5.4V)	220Ah
	10 hour rate (21.0A、5.4V)	210Ah
	5 hour rate (39.0A、5.25V)	195Ah
	1 hour rate (135A、4.8V)	135Ah
Internal Resistance	Full charged Battery77°F(25°C): 2mΩ	
Capacity affected by Temperature (20 hour rate)	104° F(40°C)	102%
	77° F(25°C)	100%
	32° F(10°C)	85%
	5° F(-15°C)	65%
Self-Discharge 68°F(20°C)	Capacity after 3 month storage	90%
	Capacity after 6 month storage	80%
	Capacity after 12month storage	60%
Max. discharge current77°F(25°C): 1200A(5S)		
Charge (Constant Voltage)	Float: 6.8~6.9 V/77° F(25°C)	
	Cycle:7.20~7.35 V/77°F(25°C) Max. Current: 55A	

SPECIFICATION

Nominal voltage 6V
 Number of cell 3
 Length(mm/inch) 260/10.2
 Width(mm/inch) 180/7.09
 Height(mm/inch) 247/9.72
 Total Height(mm/inch) 251/9.88
 Approx. Weight(kg/lbs) 31/68.3

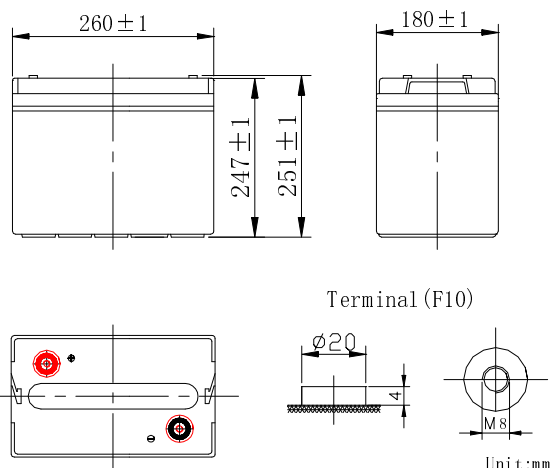

Discharge Constant Current (Amperes at 77° F25 °C)

End Point Volts/Cell	5min	10min	15min	30min	1h	3h	5h	10h	20h
1.60V		460	357	230	135	58.5	40.2	21.8	11.4
1.65V		442	345	223	132	57.8	39.9	21.7	11.4
1.70V		422	333	215	129	57.0	39.9	21.5	11.3
1.75V		400	320	207	125	56.2	39.0	21.3	11.2
1.80V		376	305	198	121	55.2	38.5	21.0	11.0

Discharge Constant Power (watts at 77° F 25°C)

End Point Volts/Cell	5min	10min	15min	30min	45min	1h	2h	3h	5h
1.60V		785	617	435	316	246	156	111	72.3
1.65V		762	601	424	309	241	152	108	71.7
1.70V		737	583	412	301	236	147	105	71.1
1.75V		710	564	400	293	230	141	102	70.6
1.80V		680	543	387	284	225	135	98.0	70.0

(Note)The above characteristics data are average values obtained Within three charge/discharge cycles not the minimum values.

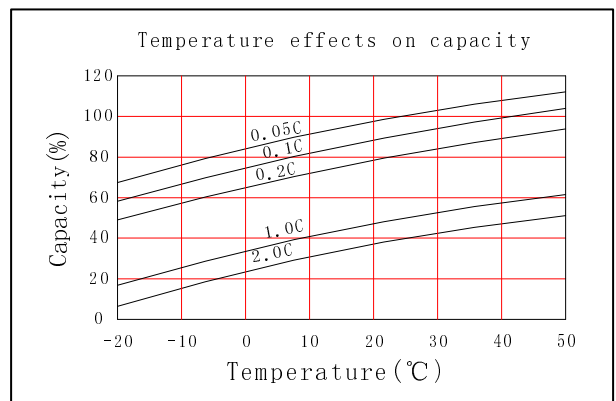
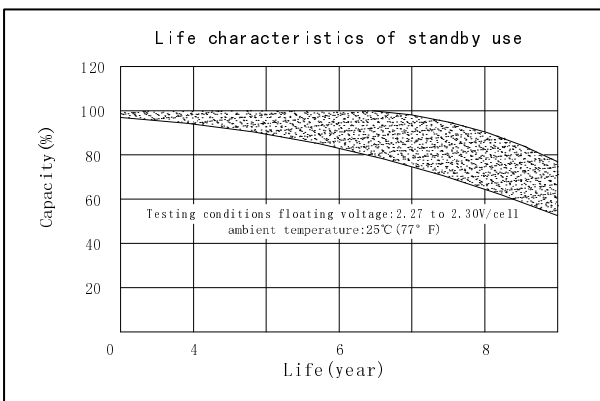
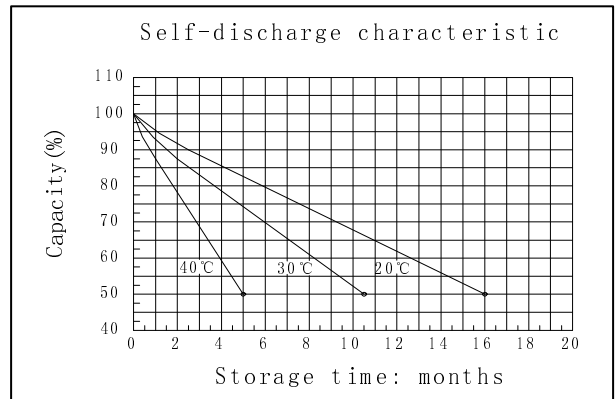
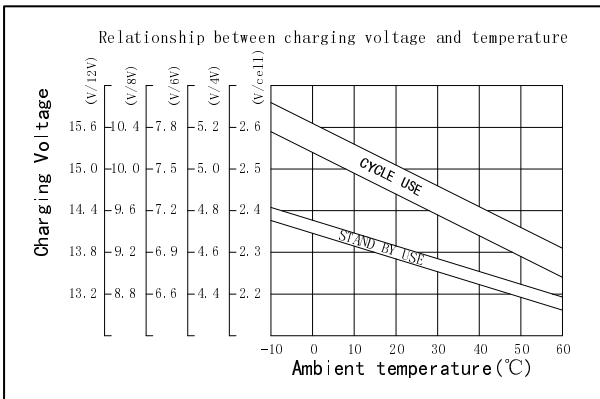
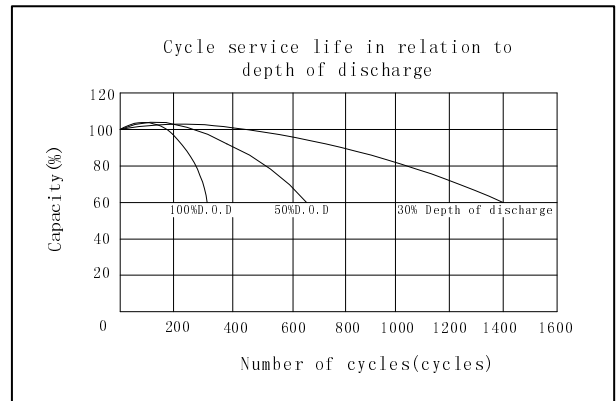
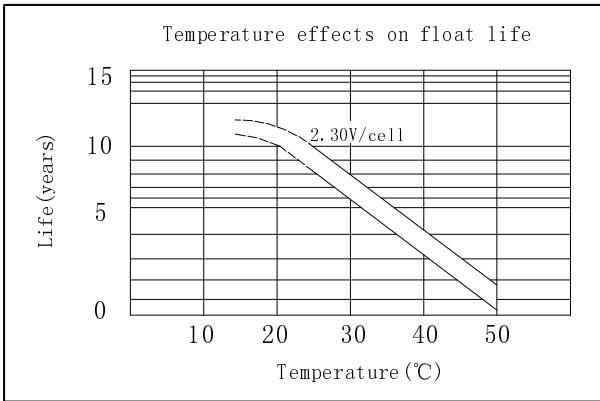
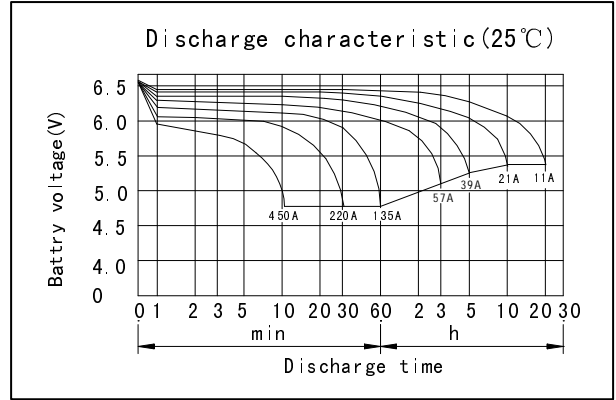
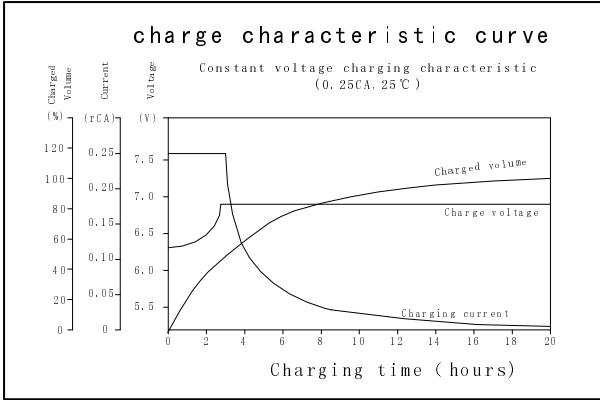

DONGGUAN OREMA POWER CO., LTD

Add: #1 Qilinling Road Shahu, Tangxia Town, Dongguan Guangdong China

TEL: +86-769- 3896 1163 +86-769- 3896 1168

FAX: +86-769- 3896 1169



www.oremabattery.com