



UN24-12X (12V24Ah/20hr)

The rechargeable batteries are lead-lead dioxide systems. The dilute sulfuric acid electrolyte is absorbed by separators and thus immobilized.

Should the battery be accidentally overcharged producing hydrogen and oxygen, Special one-way valves allow the gases to escape thus avoiding excessive pressure build-up. Otherwise, the battery is completely sealed and is, therefore, maintenance-free, leak proof and usable in any position.

Battery Construction

Component	Positive plate	Negative plate	Container	Cover	Safety valve	Terminal	Separator	Electrolyte
Raw material	Lead dioxide	Lead	ABS	ABS	Rubber	Copper	Fiberglass	Sulfuric acid

General Feature

- Absorbent Glass Mat(AGM) technology for efficient gas recombination of up to 99% and freedom from electrolyte maintenance or water adding.
- Not restricted for air transport-complies with IATA/ICAO Special Provision A67.
- UL-recognized component.
- Can be mounted in any orientation.
- Computer designed lead, calcium tin alloy grid for high power density.
- Long service life, float or cyclic applications.
- Maintenance-free operation.
- Low self discharge.

Performance Characteristics

Capacity 77°F(25°C)	20 hour rate (1.2A、10.5V)	24.0Ah
	10 hour rate (2.28A、10.5V)	22.8Ah
	5 hour rate (4.1A、10.5V)	20.5Ah
	1 hour rate (15.0A、9.6V)	15.0Ah
Internal Resistance	Full charged Battery77°F(25°C):12mΩ	
Capacity affected by Temperature (20 hour rate)	104° F(40°C)	102%
	77° F(25°C)	100%
	32° F(10°C)	85%
	5° F(-15°C)	65%
Self-Discharge 68°F(20°C)	Capacity after 3 month storage	90%
	Capacity after 6 month storage	80%
	Capacity after 12month storage	60%
Max. discharge current77°F(25°C): 300A(5S)		
Charge (Constant Voltage)	Float: 13.6~13.8 V/77° F(25°C)	
	Cycle:14.5~14.9 V/77°F(25°C) Max. Current: 6A	

SPECIFICATION

- Nominal voltage 12V
- Number of cell 6
- Length(mm/inch) 166/6.54
- Width(mm/inch) 176/6.93
- Height(mm/inch) 125/4.92
- Total Height(mm/inch) 125/4.92
- Approx. Weight(kg/lbs) 7.6/16.8

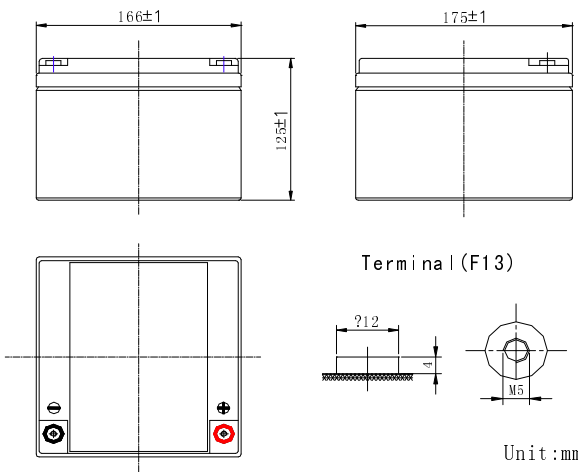

Discharge Constant Current (Amperes at 77° F 25 °C)

End Point Volts/Cell	5min	10min	15min	30min	1h	3h	5h	10h	20h
1.60V	95.0	64.0	48.0	28.5	15.0	6.68	4.47	2.41	1.24
1.65V	90.1	60.9	45.9	27.4	14.6	6.44	4.36	2.35	1.23
1.70V	84.9	57.8	43.7	26.2	14.2	6.20	4.24	2.31	1.22
1.75V	79.7	54.5	41.1	24.9	13.7	5.95	4.10	2.28	1.20
1.80V	74.3	51.3	39.1	23.6	13.2	5.71	3.95	2.25	1.18

Discharge Constant Power (watts at 77° F 25 °C)

End Point Volts/Cell	5min	10min	15min	30min	45min	1h	2h	3h	5h
1.60V	185	121	90.0	55.0	40.0	31.7	19.6	13.4	8.54
1.65V	173	114	85.1	52.3	38.2	30.3	19.0	13.1	8.39
1.70V	161	107	80.2	49.4	36.3	28.9	18.3	12.5	8.22
1.75V	151	99.7	75.2	46.6	34.3	27.5	17.6	12.0	8.03
1.80V	139	92.7	70.3	43.7	32.3	26.0	16.9	11.4	7.83

(Note)The above characteristics data are average values obtained Within three charge/discharge cycles not the minimum values.

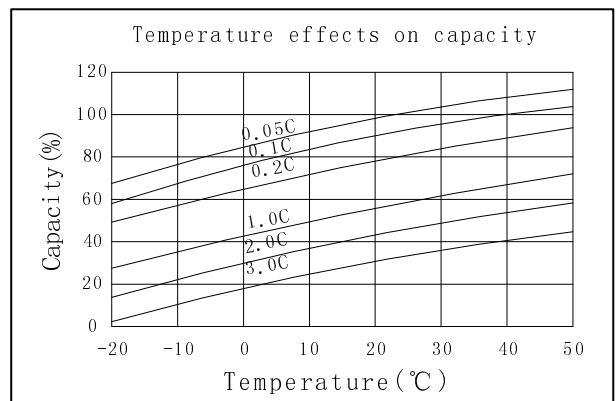
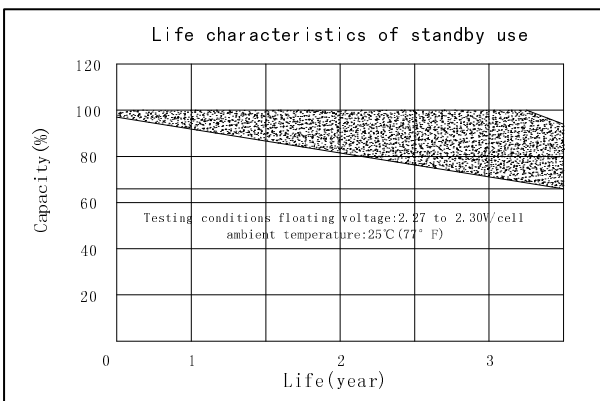
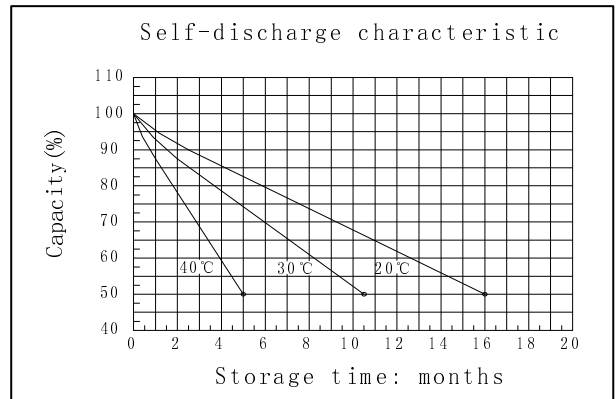
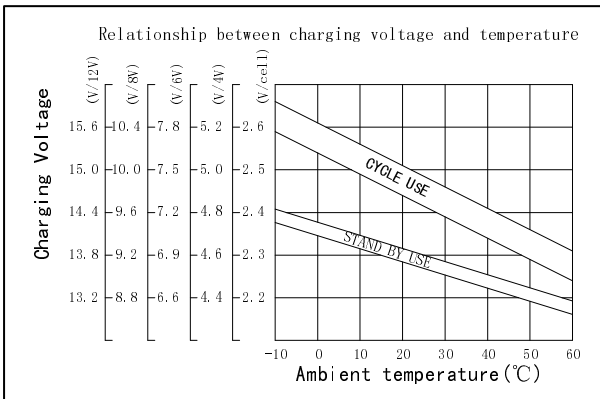
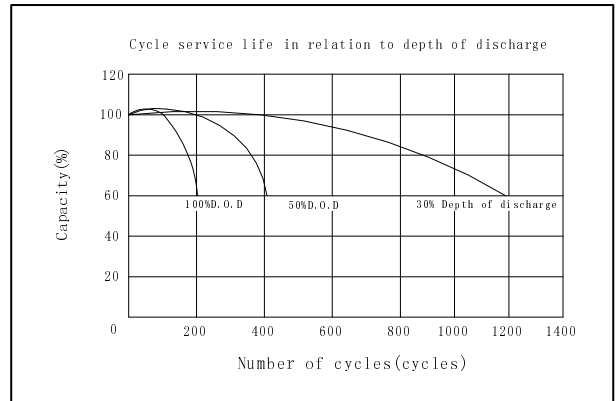
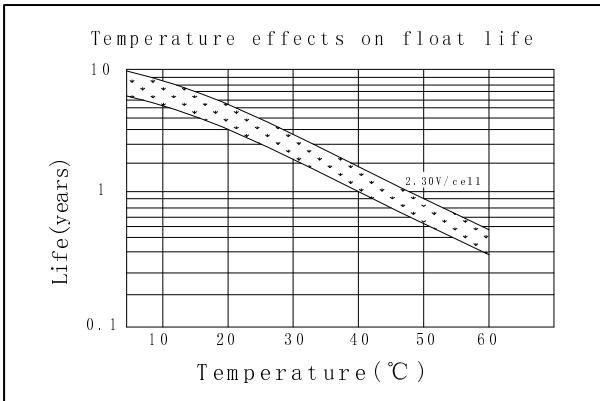
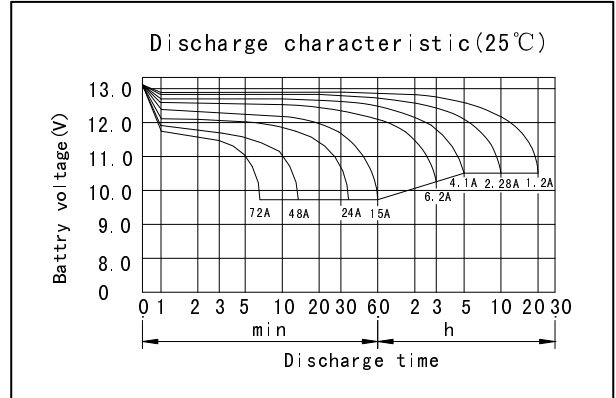
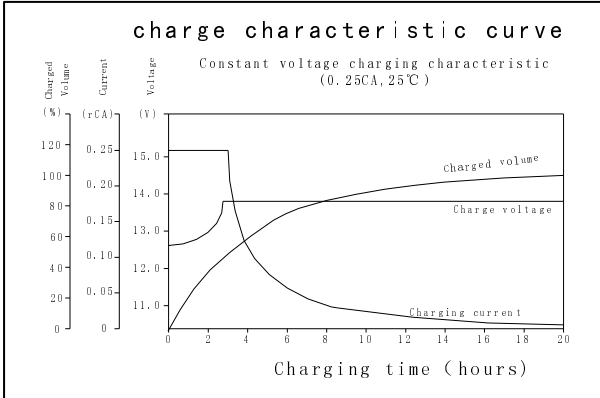

DONGGUAN OREMA POWER CO., LTD

Add: #1 Qilinling Road Shahu, Tangxia Town, Dongguan Guangdong China

TEL: +86-769- 3896 1163 +86-769- 3896 1168

FAX: +86-769- 3896 1169



www.oremabattery.com