



UNG250-12 (12V250Ah/20hr)



UNG Series is GEL battery which is manufactured with AGM separator and colloidal Silicon. Gel battery are featured with low self-discharge、strong ability to recover from deep discharging、excellent cycle life and performance at cold ambient temperatures than conventional VRLA

Battery Construction

Component	Positive plate	Negative plate	Container	Cover	Safety valve	Terminal	Separator	Electrolyte
Raw material	Lead dioxide	Lead	ABS	ABS	Rubber	Copper	Fiberglass	Colloidal silicon

General Feature

- Micro millimeter SiO₂ and H₂SO₄ technology for Efficient gas recombination of up to 99% and Freedom from electrolyte maintenance or water adding.
- Not restricted for air transport-complies with IATA/ICAO Special Provision A67.
- UL-recognized component.
- Can be mounted in any orientation.
- Computer designed lead, calcium tin alloy grid for high power density.
- Long service life, float or cyclic applications.
- Maintenance-free operation.
- Low self discharge.

SPECIFICATION

Nominal voltage 12V
 Number of cell 6
 Length(mm/inch) 520/20.5
 Width(mm/inch) 268/10.6
 Height(mm/inch) 220/8.66
 Total Height(mm/inch) 224/8.82
 Approx. Weight(kg/lbs)74/163.1

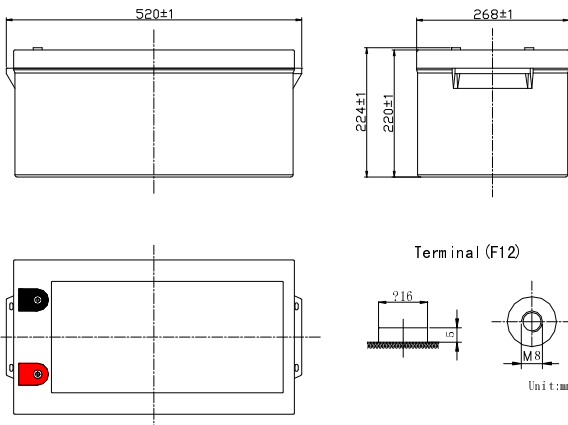

Performance Characteristics

Capacity 77°F(25°C)	100 hour rate (2.9A、 11.1V)	290Ah
	20 hour rate (12.5A、 10.8V)	250Ah
	10 hour rate (23.8A、 10.5V)	238Ah
	1 hour rate (155A、 9.6V)	155Ah
Internal Resistance	Full charged Battery77°F(25°C):4.5mΩ	
Operating Temperature Range	Discharge: -20~60°C	
	Charge: -10~60°C	
	Storage: -20~60°C	
Self-Discharge 3% of capacity declined per month at 20°C(average)		
Max. discharge current77°F(25°C): 1200A(5S)		
Charge (Constant Voltage)	Float: 13.38~13.68 V/77° F(25°C)	
	Cycle:14.28~14.52 V/77°F(25°C) Max. Current: 62.5A	

Discharge Constant Current (Amperes at 77° F25 °C)

End Point Volts/Cell	5min	10min	15min	30min	1h	3h	5h	10h	20h
1.60V		577	401	265	155	66.5	44.5	24.3	12.7
1.65V		552	382	259	152	65.8	44.0	24.2	12.7
1.70V		527	363	251	150	65.0	43.5	24.0	12.6
1.75V		502	343	243	147	64.2	43.0	23.8	12.5
1.80V		473	318	234	143	63.2	42.3	23.5	12.3

Discharge Constant Power (watts at 77° F 25 °C)

End Point Volts/Cell	5min	10min	15min	30min	45min	1h	2h	3h	5h
1.60V		981	738	511	394	322	187	143	94.6
1.65V		966	733	508	392	320	186	142	94.3
1.70V		948	726	504	389	317	184	141	94.0
1.75V		913	718	501	387	314	183	140	93.7
1.80V		875	707	496	384	310	181	138	93.3

(Note)The above characteristics data are average values obtained Within three charge/discharge cycles not the minimum values.

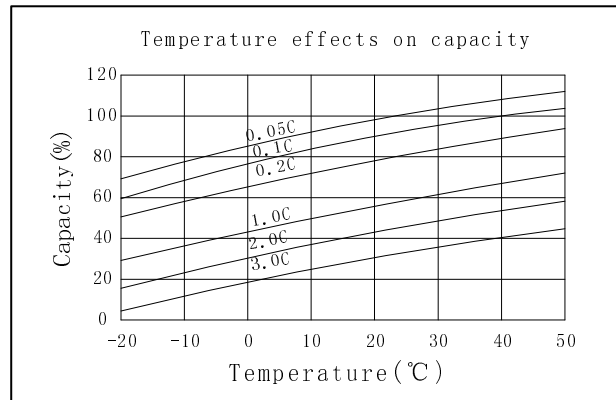
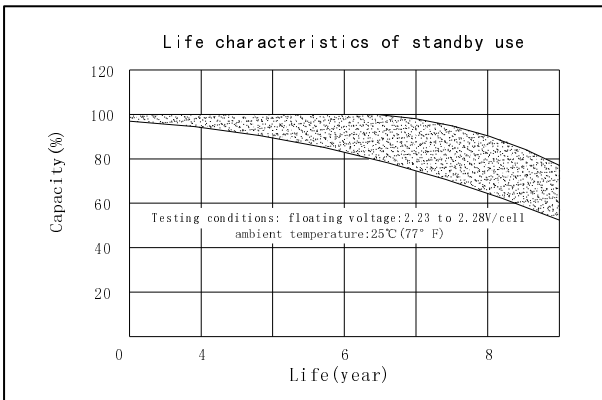
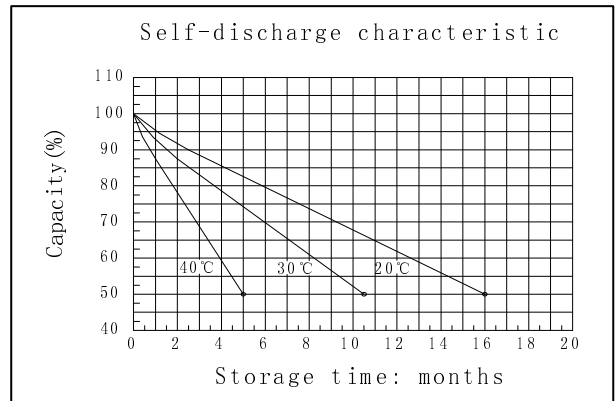
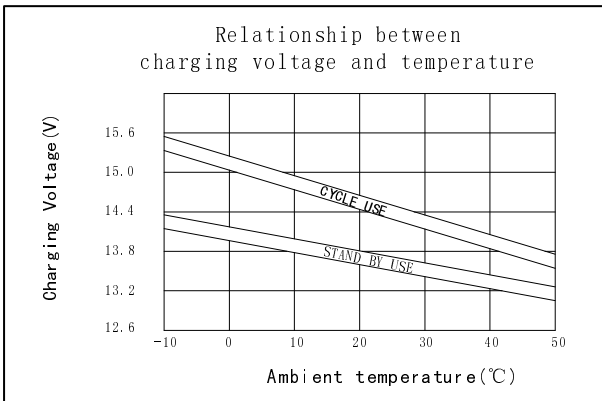
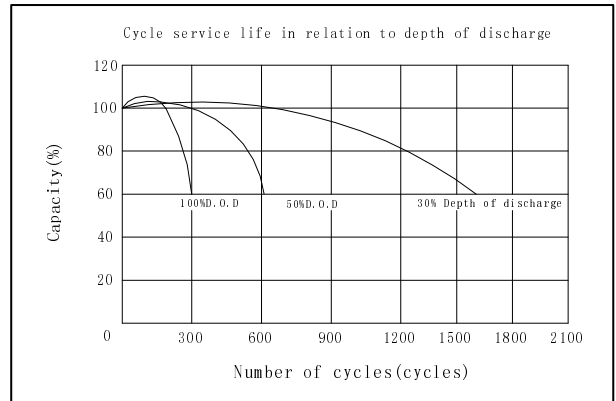
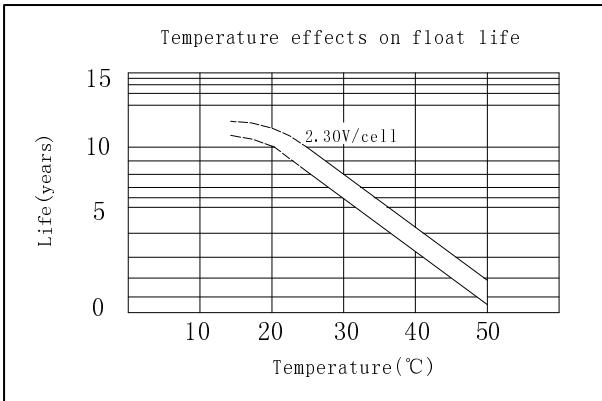
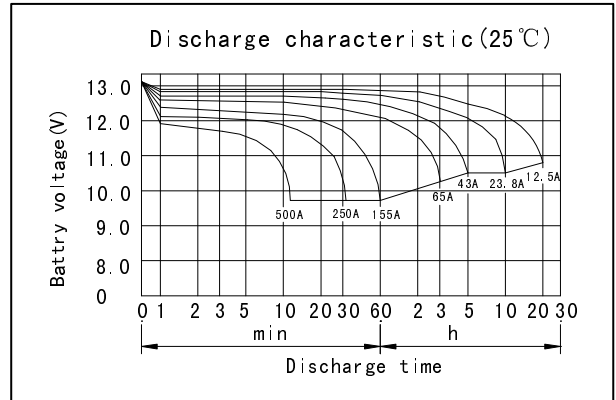
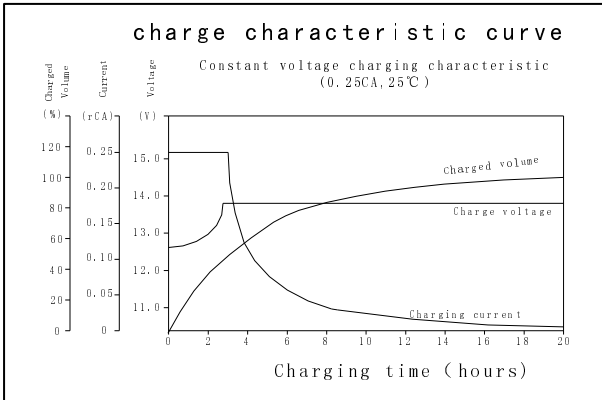

DONGGUAN OREMA POWER CO., LTD

Add: #1 Qilinling Road Shahu, Tangxia Town, Dongguan Guangdong China

TEL: +86-769- 3896 1163 +86-769- 3896 1168

FAX: +86-769- 3896 1169



www.oremabattery.com