

### Specification

Nominal Voltage	2V	
Capacity(10HR)	350.0AH (1.8V/cell,20°C)	
Dimension	Length	124±2mm (4.88 inches)
	Width	206±3mm (8.11 inches)
	Container Height	471±3mm (18.54 inches)
	Total Height (with Terminal)	526±3mm (20.71 inches)
	Without Electrolyte	21.3 kg (46.86lbs)
Approx Weight	With Electrolyte	28.3 kg (62.3lbs)
	Container Material	SAN transparent container
Rated Capacity	350.0 AH/35.0A	(10hr, 1.80V/cell, 25°C/77°F)
	311.0 AH/62.2A	(5hr, 1.75V/cell, 25°C/77°F)
	270.0 AH/90.0A	(3hr, 1.75V/cell, 25°C/77°F)
	199.9 AH/199.9A	(1hr, 1.60V/cell, 25°C/77°F)
Max. Discharge Current	2800A (5s)	
Internal Resistance	Approx 0.65mΩ	
Operating Temp. Range	Discharge	-15~50°C (5~122°F)
	Charge	0~40°C (32~104°F)
	Storage	-15~40°C (5~104°F)
Type and number of poles	M8/2	
Charging	Floating voltage:	2.23V~2.25V at 20°C(68°F)Temp.
	Boost charge:	2.30V~2.40V at 20°C(68°F)Temp.
	Charging current(max.):	0.1CA
	Temp. Coefficient	-3mV/°C
Capacity affected by Temperature	40°C (104°F)	103%
	25°C (77°F)	100%
	0°C (32°F)	86%
Self Discharge (4% per month)	Leoch OPzS batteries may be stored for up to 6 months at 20°C(68°F) and then a freshening charge is required. For higher temperatures the time interval will be shorter.	



### Applications

- ◆ Telecommunications.
- ◆ Radio and cellular telephone relay stations.
- ◆ Emergency lighting systems.
- ◆ Power stations, Conventional power stations,
- ◆ Alternative power (solar, wind).
- ◆ Large UPS and computer back-up.
- ◆ Railway signalling.
- ◆ Maritime standby power on ships and ashore.
- ◆ Standby power.
- ◆ Buoy lighting.
- ◆ Long service life, designed life 15-20 years.

### Constant Current Discharge (Amperes) at 20 °C (68°F)

F.V/Time	30min	45min	1h	1.5h	2h	3h	4h	5h	6h	8h	10h	20h
1.60V/cell	265.3	230.5	199.9	157.5	130.2	97.3	78.2	66.2	57.3	45.3	37.4	20.3
1.65V/cell	249.2	221.7	193.2	153.5	127.2	95.7	77.1	65.3	56.5	44.8	37.0	20.1
1.70V/cell	236.6	209.1	185.9	148.6	124.3	92.9	75.3	63.9	55.4	44.0	36.4	19.8
1.75V/cell	221.9	199.3	176.4	141.6	119.0	90.0	73.1	62.2	54.1	43.2	35.8	19.5
1.80V/cell	197.4	179.7	162.4	132.8	111.8	85.4	69.9	59.6	52.1	42.1	35.0	19.1
1.85V/cell	157.5	148.9	139.0	118.1	101.5	78.2	64.7	55.9	49.1	40.0	33.5	18.4

### Constant Power Discharge (Watts) at 20 °C (68°F)

F.V/Time	30min	45min	1h	1.5h	2h	3h	4h	5h	6h	8h	10h	20h
1.60V/cell	452.9	403.4	354.8	283.1	236.8	178.2	144.5	123.1	107.2	85.2	70.7	38.5
1.65V/cell	434.6	392.5	345.9	277.4	232.5	176.1	143.1	122.0	106.3	84.6	70.2	38.3
1.70V/cell	418.3	374.1	335.2	270.3	228.1	171.8	140.4	119.9	104.6	83.4	69.3	37.9
1.75V/cell	398.9	360.3	321.2	259.5	220.0	167.4	136.8	117.2	102.4	82.3	68.4	37.4
1.80V/cell	359.7	329.9	299.5	246.0	208.6	160.2	131.8	112.9	99.3	80.5	67.3	36.9
1.85V/cell	291.8	277.3	260.0	221.8	191.4	148.2	123.2	106.8	94.2	77.1	65.0	35.8

Specifications subject to change without notice.



## Dimensions

### Terminal (mm)

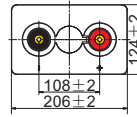
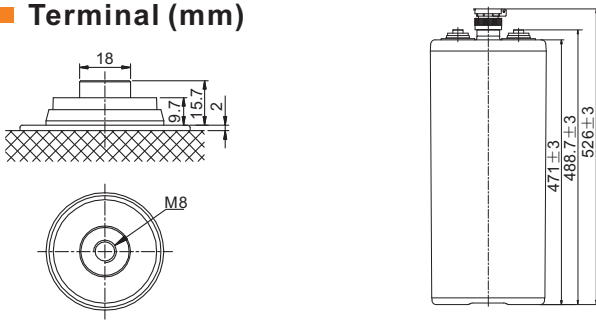

## Discharge Characteristics

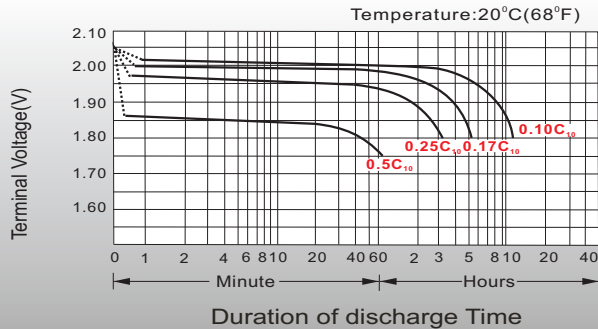

## Charge voltage Vs ambient temperature curve

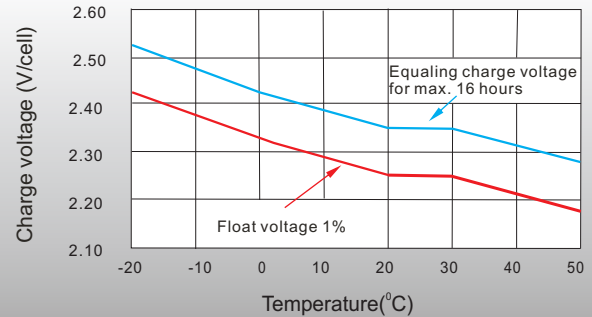

## Discharge capacity Vs Ambient temperature curve (I10A)

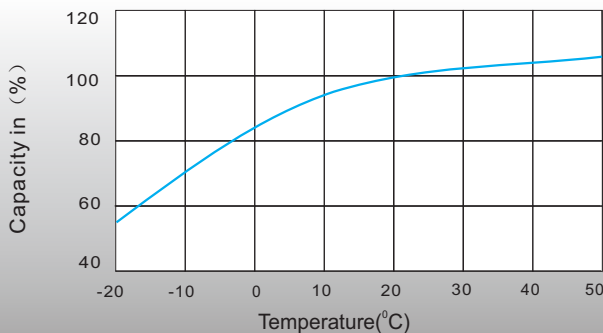

## Relation curves of service life and ambient temperature

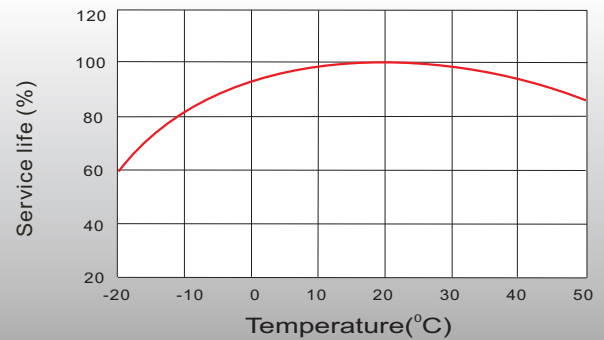

## Self Discharge Characteristics

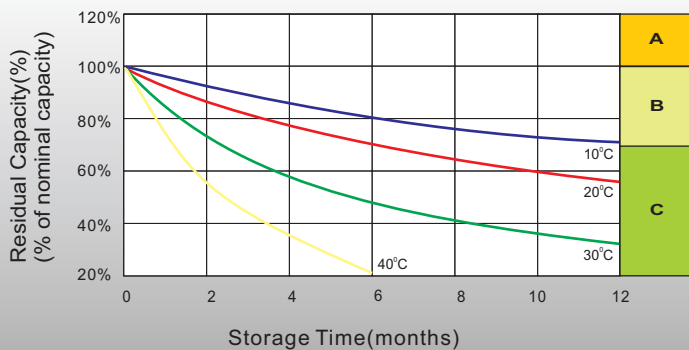

- A** No supplementary charge required (Carry out supplementary charge before use if 100% capacity is required.)
- B** Supplementary charge required before use. Optional charging way as below:
  1. Charged for above 3 days at limited current 0.1CA and constant voltage 2.25V/cell.
  2. Charged for above 20 hours at limited current 0.1CA and constant voltage 2.45V/cell.
  3. Charged for 8~10 hours at limited current 0.05CA.
- C** Supplementary charge may often fail to recover the capacity. The battery should never be left standing till this is reached.

## Sales Office

### China sales office:

Add: 5th Floor, Xinbaohui Bldg., Nanhai Blvd, Nanshan, Shenzhen, China. 518052  
Tel: +86-755-86036060 (100 lines)  
Fax: +86-755-26067269  
E-mail: export@leoch.com  
Http://www.leoch.com

### HongKong sales office:

Add: Workshop C, 33/F, TML Tower, No. 3 Hoi Shing Road, Tsuen Wan, New Territories, Hong Kong  
Tel: +852 35786666  
Fax: +852 21170016  
E-mail: sales.hk@leoch.com

### Singapore sales office:

Add: NO.1 Tech Park Crescent, Singapore 638131  
Tel: +65 68416629  
Fax: +65 68443210  
Email sales.sg@leoch.com

### North America sales office:

Add: 19751 Descartes, Unit A, Foothill Ranch, CA 92610, USA  
Tel: 949-588-5853  
Fax: 949-588-5966  
E-mail: sales@leoch.us  
Http://www.leoch.com

### Europe sales office:

Add: 9B Wheatstone Park, Waterwells Business Park, Gloucester, GL2 2AQ, UK United Kingdom  
Tel: +44(0) 1452 729428/1452 729696  
Fax: +44 (0)1452-690125  
E-mail: Sales.Europe@leoch.com