

Tubular gel technology



NorthStar OPzV Solar Batteries are optimized for higher cycle life at deep discharges.

- Designed by NorthStar
- High capacity
- Maintenance free - no need to refill water
- ABS container
- V0 material optional
- M10 brass terminal
- Operating temperature range -20°C to +55°C (-4°F to +131°F)
- Low gassing enables low ventilation requirements
- Optional vent tubing adaptors available
- IEC 60896-21/22 compliant
- DIN 40742 EUROBAT design life definition: Long Life (12+ years)
- Shelf life of up to 24 months
- Not subject to road transport regulations (ADR) when packed properly

NSB 2-700 Solar

Nominal Technical Specifications

Dimensions

Length	168 mm	Width	208 mm
Height over pillar	483.5 mm	Height with connectors	509 mm
Weight	39.5 kg		

Electrical

Internal resistance (mOhm)	0,46
Short circuit current (A)	4400
Operation temperature range	-20°C to +55°C (-4°F to +131°F)

Electrical Data at 20°C (68°F)

Type	C10 Ah	C24 Ah	C48 Ah	C72 Ah	C100 Ah	C120 Ah
Ue (100%)/VPC	1.80	1.85	1.85	1.85	1.85	1.85
NSB 2-700 Solar	543	602	644	665	673	695

Electrical Data at 25°C (77°F)

Type	C10 Ah	C24 Ah	C48 Ah	C72 Ah	C100 Ah	C120 Ah
Ue (100%)/VPC	1.80	1.85	1.85	1.85	1.85	1.85
NSB 2-700 Solar	560	621	664	686	694	717

Technical Drawing

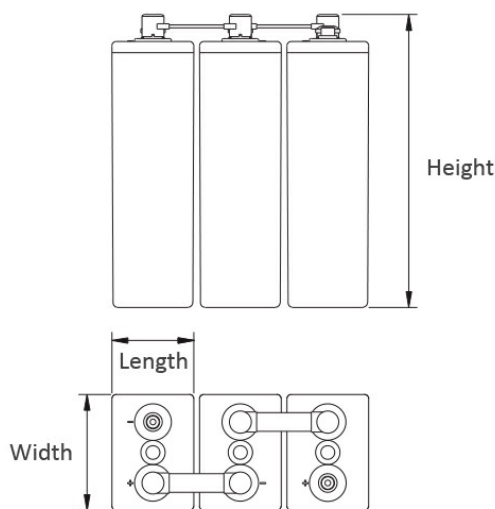

All NorthStar OPzV batteries are compliant with ISO 9001, ISO 14001 and ISO 18001.

NorthStar Americas PARTIAL
NorthStar Battery Company LLC
4000 Continental Way
Springfield, MO, 65803,
United States of America
info@northstarbattery.com
Tel: +1 417 575 8200
Fax: +1 417 575 8250

NorthStar Europe
SiteTel Sweden AB
Haukadalsgatan 8A
SE-164 40 Kista,
Stockholm, Sweden
europe@northstarbattery.com
Tel: +46 8 410 102 00
Fax: +46 8 638 06 00

NorthStar Middle East, Africa
NorthStar Battery DMCC
Office 702, Saba 1 Tower
Jumeirah Lake Towers, Dubai
United Arab Emirates
mea@northstarbattery.com
Tel: +971 4 423 8060
Fax: +971 4 423 8061

NorthStar Asia-Pacific
NS Asia Pacific Sdn. Bhd.
B2-3A-13A, Solaris Dutamas
No. 1, Jalan Dutamas 1, 50480
Kuala Lumpur, Malaysia
asia@northstarsitetel.com
Tel: +60 3 6419 0711