

NPG12-80Ah 12V80Ah

Specifications

Nominal Voltage		12V
Rated capacity (10 hour rate)		80Ah
Dimensions	Length	260±2mm(10.24inch)
	Width	168±2mm(6.61inch)
	Height	211±2mm(8.31inch)
	Total Height	215±2mm(8.46inch)
Approx. Weight		25.3kg(53.3lbs)±3%



Outer dimensions (mm)

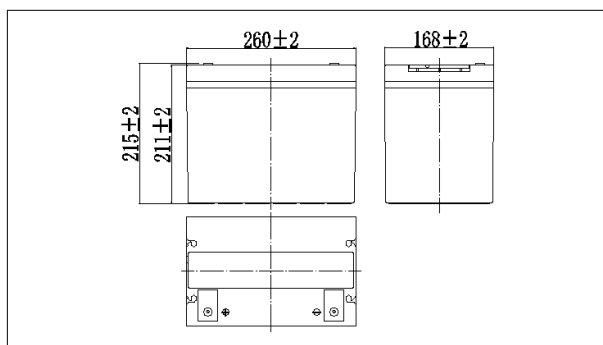

Terminal Type (mm)

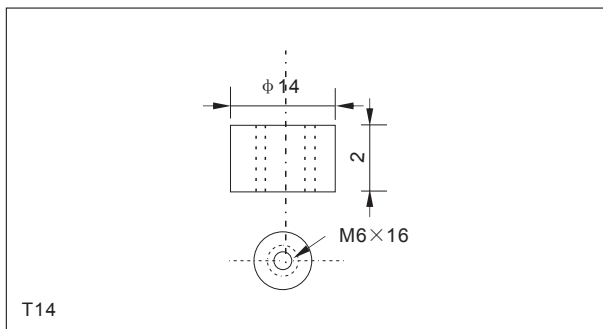

Characteristics

Capacity (25°C)	10HR(10.8V)	80Ah
	3HR(10.8V)	60Ah
	1HR(10.5V)	44Ah
Terminal type		T14
Internal resistance (Fully charged, 25°C)		Approx. 5.5m Ω
Capacity affected by temperature (10HR)	40°C	102%
	25°C	100%
	0°C	85%
	-15°C	65%
Self-discharge (25°C)	3 months	Remaining Capacity:91%
	6 months	Remaining Capacity:82%
	12 months	Remaining Capacity:65%
Nominal operating temperature		25°C ±3°C(77°F ±5°F)
Operating temperature range	Discharge	-15°C~50°C(5°F~122°F)
	Charge	-10°C~50°C(14°F~122°F)
	Storage	-20°C~50°C(-4°F~122°F)
Float charging voltage(25°C)		13.50 to 13.80V Temperature compensation: -18mV/°C
Cyclic charging voltage(25°C)		14.50 to 14.70V Temperature compensation: -30mV/°C
Maximum charging current		16A
Maximum discharge current		700A(5 sec.)
Designed floating life(20°C)		12years

Construction

Component	Positive plate	Negative plate	Container	Cover	Separator	Electrolyte	Safety valve	Terminal
Raw material	Lead dioxide	Lead	ABS	ABS	AGM	Gel	Rubber	Copper

Constant Current Discharge Characteristics Unit:A(25°C,77°F)

F.V/Time	10min	15min	30min	60min	2h	3h	4h	5h	8h	10h	20h
9.60V	156	128	77.6	48.0	29.2	20.8	16.3	13.9	9.79	8.14	4.32
9.90V	151	125	76.0	47.3	29.1	20.7	16.2	13.8	9.73	8.13	4.31
10.2V	145	120	73.7	46.1	28.8	20.5	16.1	13.7	9.67	8.10	4.30
10.5V	139	116	71.9	44.6	28.4	20.4	16.0	13.6	9.60	8.06	4.27
10.8V	131	110	69.3	43.2	27.6	20.0	15.5	13.2	9.31	8.00	4.24

Constant Power Discharge Characteristics Unit:W(25°C,77°F)

F.V/Time	10min	15min	30min	60min	2h	3h	4h	5h	8h	10h	20h
9.60V	1685	1405	871	547	339	245	192	164	116	97.2	51.8
9.90V	1634	1372	853	539	337	243	191	163	116	97.0	51.7
10.2V	1567	1321	827	525	334	242	189	162	115	96.8	51.5
10.5V	1499	1276	807	509	329	240	188	161	114	96.2	51.2
10.8V	1415	1209	778	492	320	235	183	156	111	95.5	50.9

Note: The above characteristics data can be obtained within three charge or discharge cycles.

NPG12-80Ah 12V80Ah

● **Discharge characteristics(25°C)**



● **Charging characteristics (25°C)**

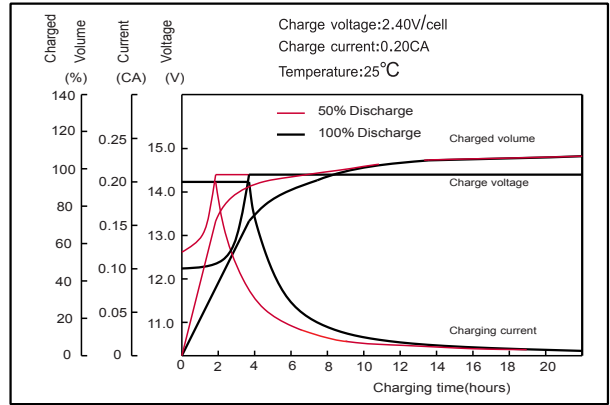

● **Temperature effects on Capacity**

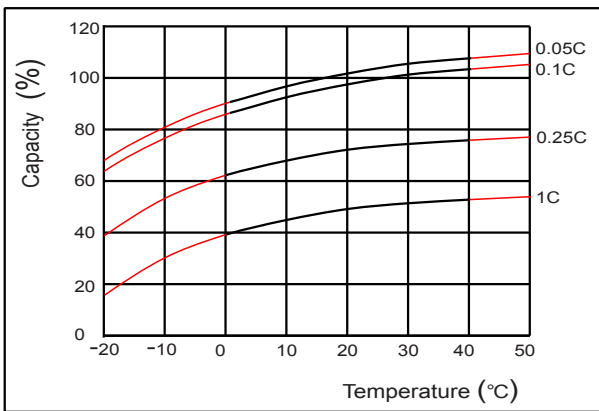

● **Self-discharge characteristics**



● **Floating life on Temperature**

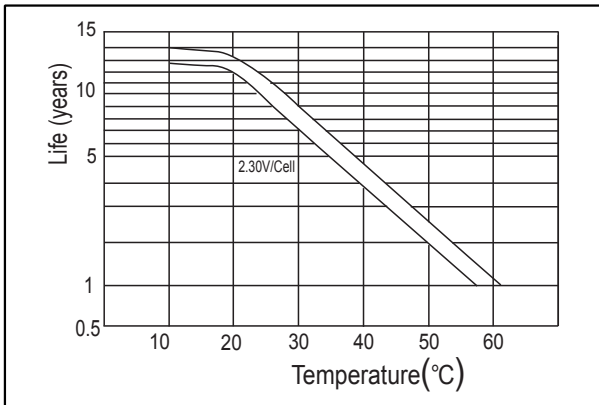

● **Cycle life on D.O.D (25°C)**

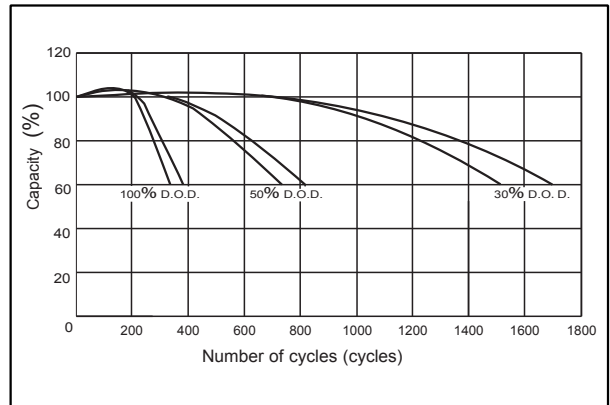

● **The relationship for OCV and Capacity (25°C)**

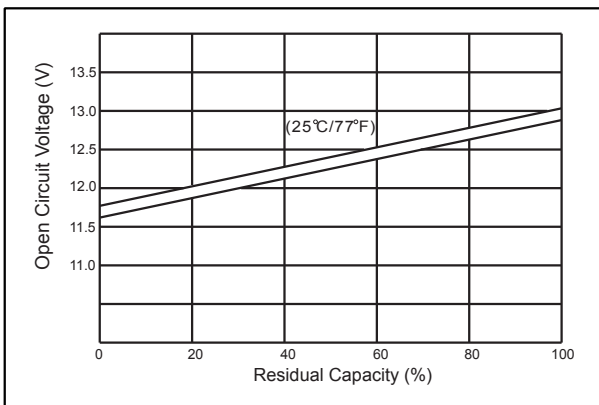

● **The relationship for Charging voltage and Temperature**

