

Specifications

Nominal Voltage		18 V
Capacity (25°C)	20HR(15.75V)	9Ah
	10HR(15.75V)	8.4Ah
	1HR(14.40V)	5.9Ah
Dimension	Length	151 ± 1.5mm (5.94inch)
	Width	102 ± 1mm (4.02inch)
	Height	100 ± 1mm (3.94inch)
	Total Height	100 ± 1mm (3.94inch)
Approx. Weight		4.0kg (8.82lbs) ± 5%
Terminal type		Plug
Internal resistance (Fully charged, 25°C)		Approx. 40mΩ
Capacity affected by temperature (20HR)	40°C	102%
	25°C	100%
	0°C	85%
	-15°C	65%
Self-discharge (25°C)	3 month	Remaining Capacity: 91%
	6 month	Remaining Capacity: 82%
	12 month	Remaining Capacity: 65%
Nominal operating temperature		25°C ± 3°C (77°F ± 5°F)
Operating temperature range	Discharge	-15°C ~ 50°C (5°F ~ 122°F)
	Charge	-10°C ~ 50°C (14°F ~ 122°F)
	Storage	-20°C ~ 50°C (-4°F ~ 122°F)
Float charging voltage(25°C)		20.40 to 20.70V Temperature compensation: -27mV/°C
Cyclic charging voltage(25°C)		21.75 to 22.35V Temperature compensation: -45mV/°C
Maximum charging current		2.7A
Terminal material		Wire Plug
Maximum discharge current		20A(5 sec.)
Designed floating life(20°C)		3~5 years

Dimensions

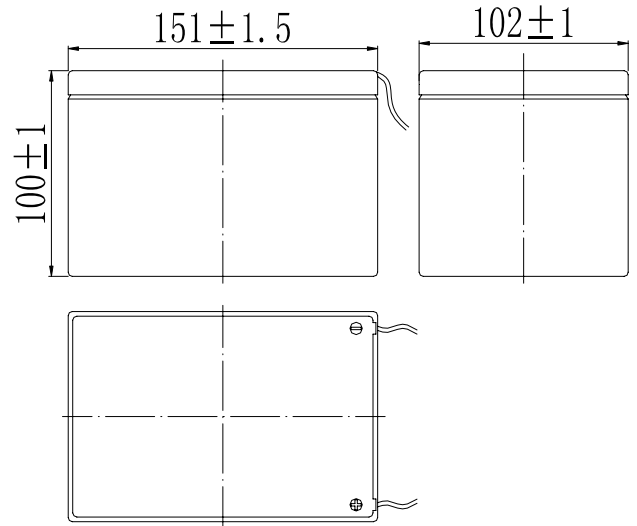

- ◆ Absorbent glass mat technology;
- ◆ Recognized by UL & CE;
- ◆ ABS container.

Constant Current Discharge Characteristics (A, 25°C)

F.V/TIME	10min	15min	30min	60min	2h	3h	4h	5h	8h	10h	20h
14.40V	--	--	--	5.91	3.20	2.30	1.84	1.56	1.01	0.85	0.46
14.85V	--	--	--	5.82	3.18	2.28	1.83	1.55	1.00	0.85	0.45
15.30V	--	--	--	5.67	3.15	2.27	1.81	1.54	1.00	0.84	0.45
15.75V	--	--	--	5.56	3.10	2.25	1.80	1.53	0.99	0.84	0.45
16.20V	--	--	--	5.39	3.02	2.18	1.75	1.48	0.96	0.82	0.44

Constant Power Discharge Characteristics (Watt, 25°C)

F.V/TIME	10min	15min	30min	60min	2h	3h	4h	5h	8h	10h	20h
14.40V	--	--	--	103	56.1	40.9	32.8	28.0	18.2	15.3	8.22
14.85V	--	--	--	101	55.8	40.7	32.6	27.8	18.1	15.2	8.19
15.30V	--	--	--	98.5	55.3	40.4	32.4	27.6	17.9	15.2	8.15
15.75V	--	--	--	96.6	54.5	40.1	32.2	27.4	17.8	15.1	8.10
16.20V	--	--	--	93.6	53.1	38.9	31.2	26.6	17.3	14.8	7.94

Note: The above characteristics data can be obtained within three charge/discharge cycles.

Discharge Characteristics(25°C)

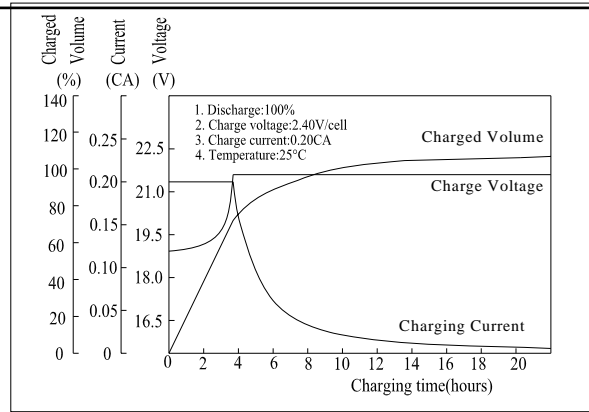
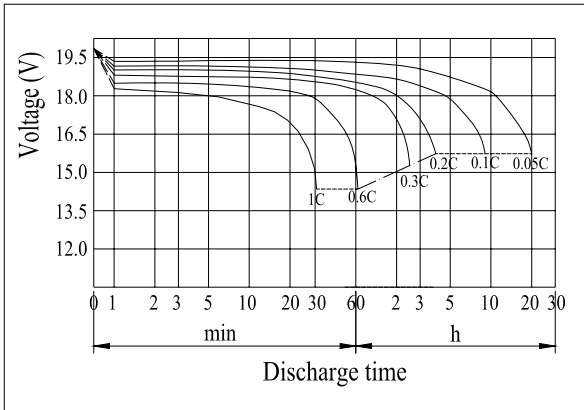

Effect of Temperature on Capacity

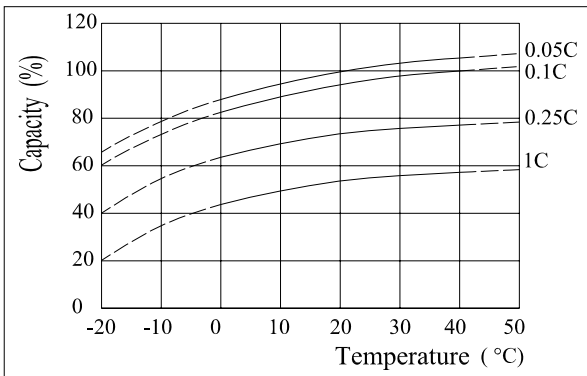

Self-discharge Characteristics

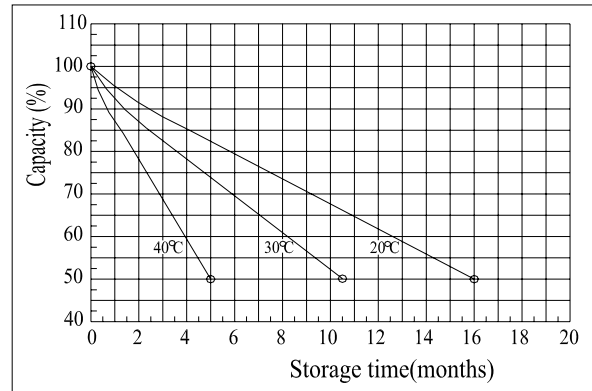

The Relationship for Open Circuit Voltage and Residual Capacity (25°C)

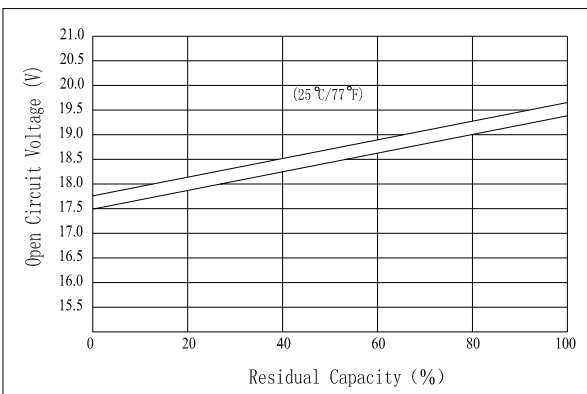

The Relationship for Charging Voltage and Temperature

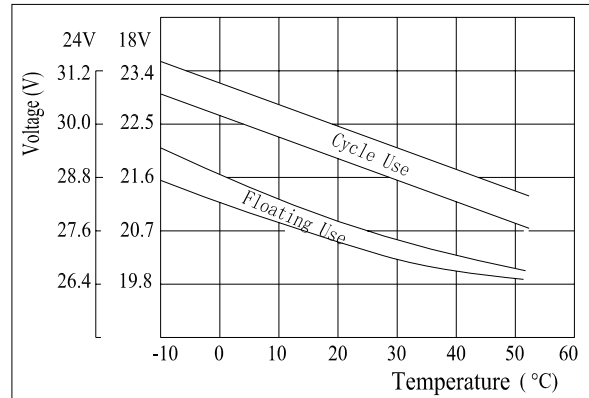

Floating Life on Temperature

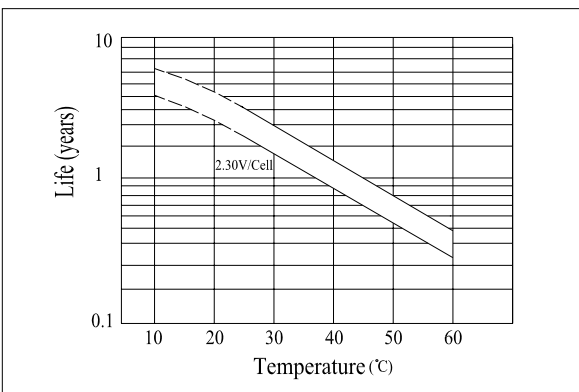

Cycle Life on D.O.D(25°C)

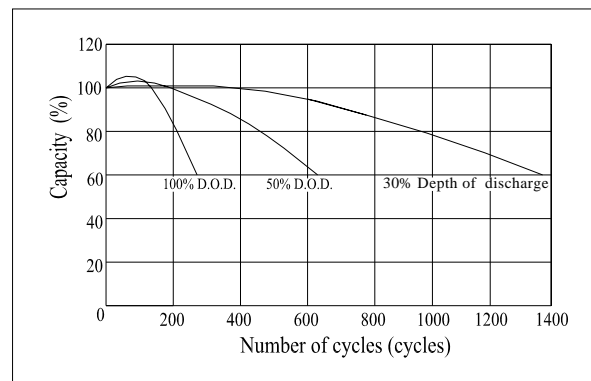

Charging Characteristics(25°C)