

Specifications

Nominal Voltage		24 V
Capacity (25°C)	20HR(21.0V)	4.5Ah
	10HR(21.0V)	4.2Ah
	1HR(19.2V)	2.95Ah
Dimension	Length	206 ± 2mm (8.11inch)
	Width	77 ± 1mm (3.03inch)
	Height	74 ± 1mm (2.91inch)
	Total Height	74 ± 1mm (2.91inch)
Approx. Weight		3.1kg (6.84lbs) ± 5%
Terminal type		Plug
Internal resistance (Fully charged, 25°C)		Approx. 65mΩ
Capacity affected by temperature (20HR)	40°C	102%
	25°C	100%
	0°C	85%
	-15°C	65%
Self-discharge (25°C)	3 month	Remaining Capacity: 91%
	6 month	Remaining Capacity: 82%
	12 month	Remaining Capacity: 65%
Nominal operating temperature		25°C ± 3°C (77°F ± 5°F)
Operating temperature range	Discharge	-15°C ~ 50°C (5°F ~ 122°F)
	Charge	-10°C ~ 50°C (14°F ~ 122°F)
	Storage	-20°C ~ 50°C (-4°F ~ 122°F)
Float charging voltage(25°C)		27.2 to 27.6V Temperature compensation: -36mV/°C
Cyclic charging voltage(25°C)		29.0 to 29.8V Temperature compensation: -60mV/°C
Maximum charging current		1.35A
Terminal material		Wire Plug
Maximum discharge current		20A(5 sec.)
Designed floating life(20°C)		3~5 years

Dimensions

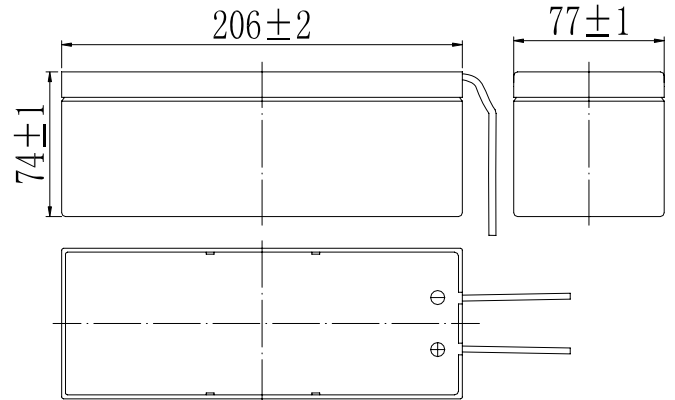

- ◆ Absorbent glass mat technology;
- ◆ Recognized by UL & CE;
- ◆ ABS container.

Constant Current Discharge Characteristics (A, 25°C)

F.V/TIME	10min	15min	30min	60min	2h	3h	4h	5h	8h	10h	20h
19.2V	--	--	4.82	2.95	1.60	1.15	0.92	0.78	0.50	0.42	0.228
19.8V	--	--	4.72	2.91	1.59	1.14	0.91	0.78	0.50	0.42	0.227
20.4V	--	--	4.58	2.84	1.58	1.13	0.91	0.77	0.50	0.42	0.226
21.0V	--	--	4.47	2.78	1.55	1.13	0.90	0.77	0.50	0.42	0.225
21.6V	--	--	4.30	2.69	1.51	1.09	0.87	0.74	0.48	0.41	0.221

Constant Power Discharge Characteristics (Watt, 25°C)

F.V/TIME	10min	15min	30min	60min	2h	3h	4h	5h	8h	10h	20h
19.2V	--	--	110	68.4	37.4	27.3	21.9	18.6	12.1	10.2	5.48
19.8V	--	--	108	67.4	37.2	27.1	21.7	18.5	12.0	10.2	5.46
20.4V	--	--	105	65.7	36.9	26.9	21.6	18.4	12.0	10.1	5.43
21.0V	--	--	102	64.4	36.3	26.7	21.4	18.3	11.9	10.0	5.40
21.6V	--	--	98.6	62.4	35.4	25.9	20.8	17.7	11.5	9.84	5.29

Note: The above characteristics data can be obtained within three charge/discharge cycles.

Discharge Characteristics(25°C)

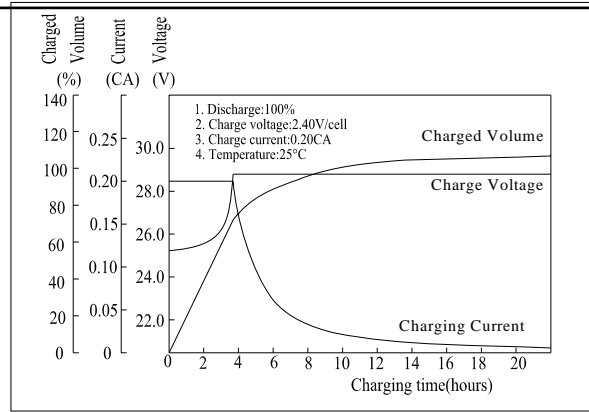
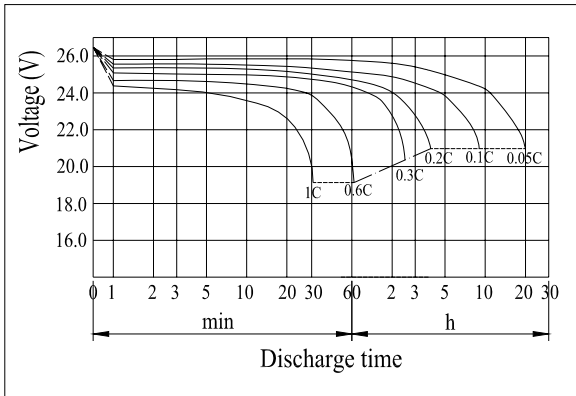

Effect of Temperature on Capacity

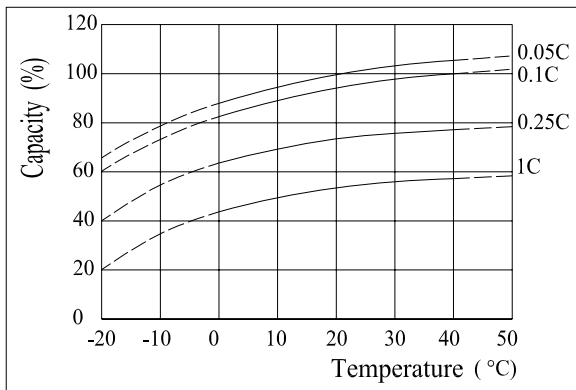

Self-discharge Characteristics

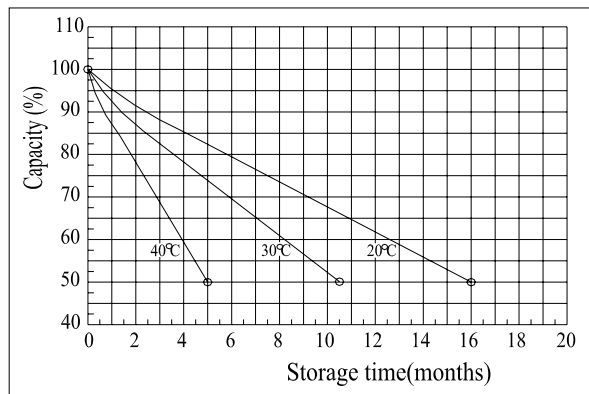

The Relationship for Open Circuit Voltage and Residual Capacity (25°C)

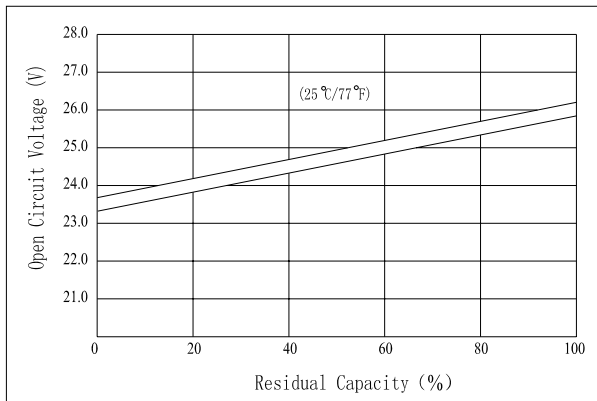

The Relationship for Charging Voltage and Temperature

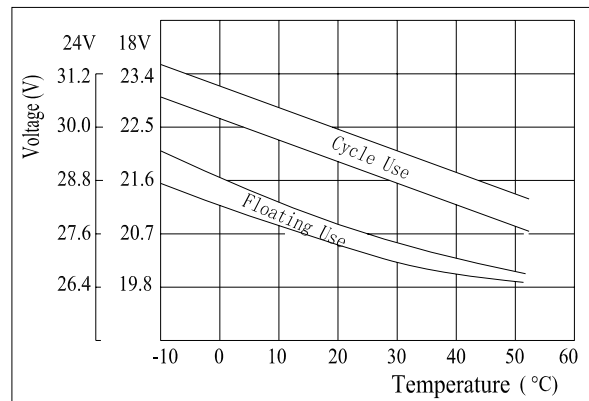

Floating Life on Temperature

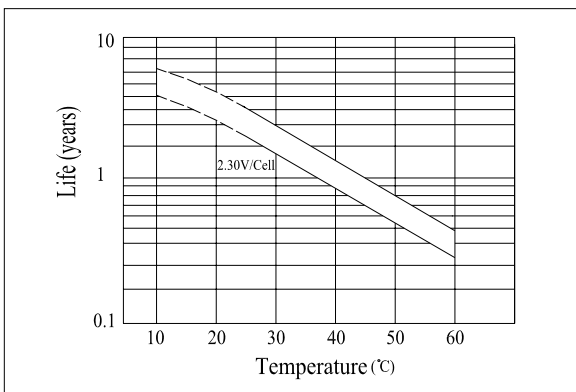

Cycle Life on D.O.D(25°C)

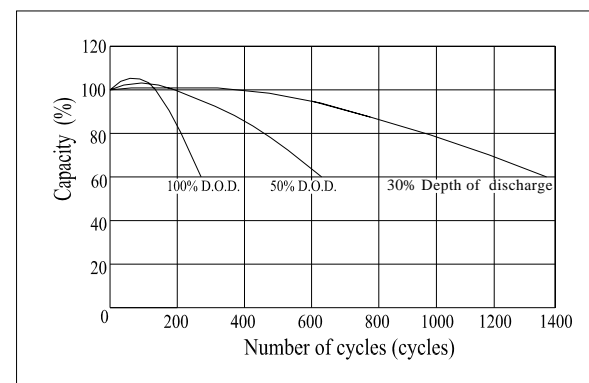

Charging Characteristics(25°C)