

Specifications

Nominal Voltage		24 V
Capacity (25°C)	20HR(21.0V)	14Ah
	10HR(21.0V)	13Ah
	3HR(21.0V)	10.5Ah
Dimension	Length	300±2mm (11.81inch)
	Width	98±1mm (3.86inch)
	Height	103±1mm (4.06inch)
	Total Height	103±1mm (4.06inch)
Approx. Weight		8.0kg (17.64lbs)±5%
Terminal type		Plug
Internal resistance (Fully charged, 25°C)		Approx. 45mΩ
Capacity affected by temperature (20HR)	40°C	102%
	25°C	100%
	0°C	85%
	-15°C	65%
Self-discharge (25°C)	3 month	Remaining Capacity: 91%
	6 month	Remaining Capacity: 82%
	12 month	Remaining Capacity: 65%
Nominal operating temperature		25°C ± 3°C (77°F ± 5°F)
Operating temperature range	Discharge	-15°C ~ 50°C (5°F ~ 122°F)
	Charge	-10°C ~ 50°C (14°F ~ 122°F)
	Storage	-20°C ~ 50°C (-4°F ~ 122°F)
Float charging voltage(25°C)		27.2 to 27.6V Temperature compensation: -36mV/°C
Cyclic charging voltage(25°C)		29.0 to 29.8V Temperature compensation: -60mV/°C
Maximum charging current		4.2A
Terminal material		Wire Plug
Maximum discharge current		20A(5 sec.)
Designed floating life(20°C)		3~5 years

Dimensions

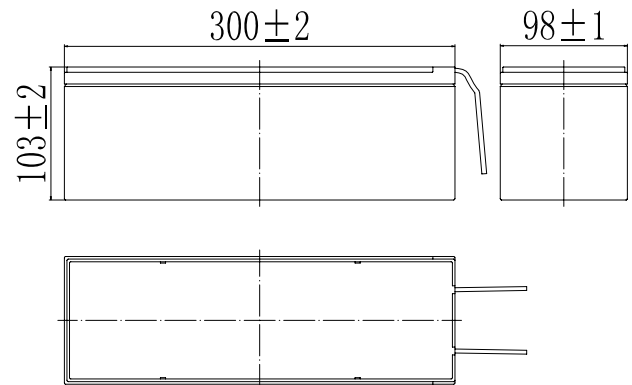

- ◆ Absorbent glass mat technology;
- ◆ Recognized by UL & CE;
- ◆ ABS container.

Constant Current Discharge Characteristics (A, 25°C)

F.V/TIME	10min	15min	30min	60min	2h	3h	4h	5h	8h	10h	20h
19.2V	--	--	--	--	4.97	3.57	2.86	2.43	1.57	1.32	0.71
19.8V	--	--	--	--	4.94	3.55	2.84	2.41	1.56	1.32	0.71
20.4V	--	--	--	--	4.90	3.52	2.82	2.40	1.55	1.31	0.70
21.0V	--	--	--	--	4.83	3.50	2.80	2.38	1.54	1.30	0.70
21.6V	--	--	--	--	4.70	3.40	2.72	2.31	1.49	1.28	0.69

Constant Power Discharge Characteristics (Watt, 25°C)

F.V/TIME	10min	15min	30min	60min	2h	3h	4h	5h	8h	10h	20h
19.2V	--	--	--	--	116	84.8	68.0	58.0	37.7	31.7	17.1
19.8V	--	--	--	--	116	84.3	67.6	57.6	37.5	31.6	17.0
20.4V	--	--	--	--	115	83.7	67.2	57.2	37.2	31.4	16.9
21.0V	--	--	--	--	113	83.2	66.7	56.8	37.0	31.2	16.8
21.6V	--	--	--	--	110	80.7	64.7	55.1	35.9	30.6	16.5

Note: The above characteristics data can be obtained within three charge/discharge cycles.

Discharge Characteristics(25°C)

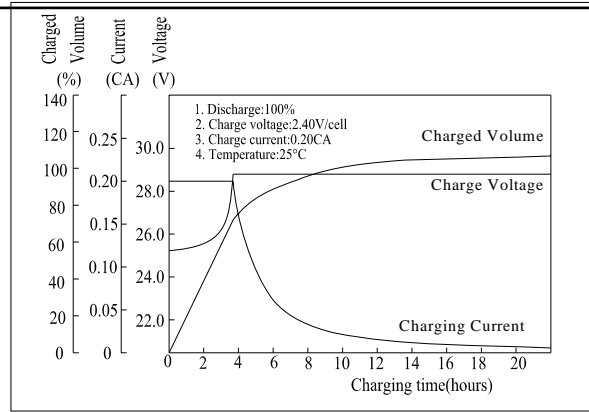
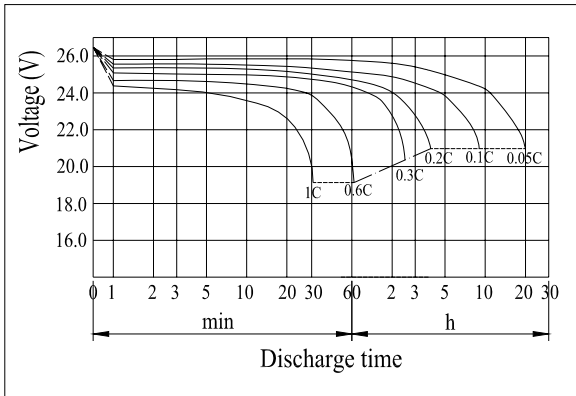

Effect of Temperature on Capacity

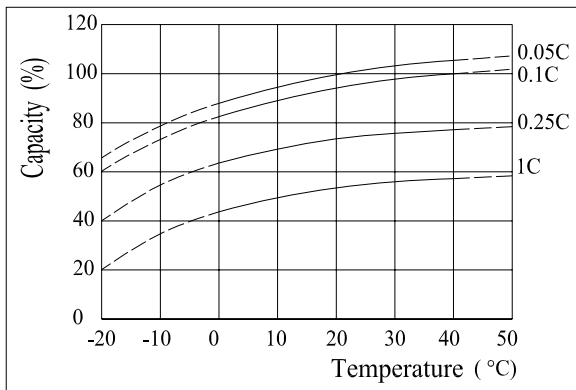

Self-discharge Characteristics

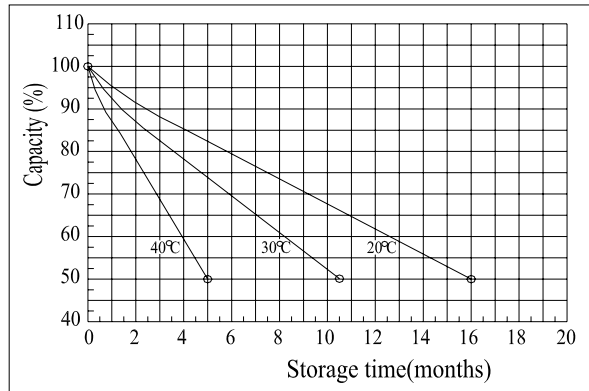

The Relationship for Open Circuit Voltage and Residual Capacity (25°C)

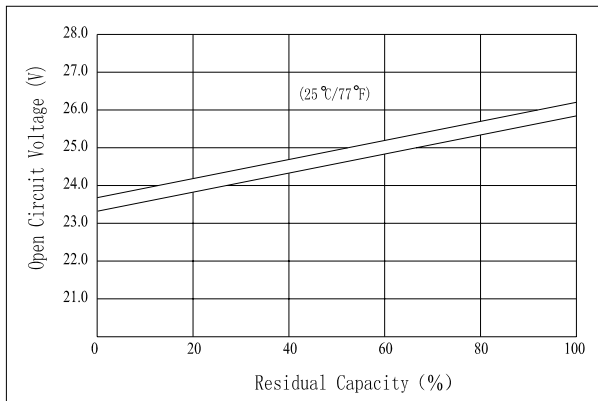

The Relationship for Charging Voltage and Temperature

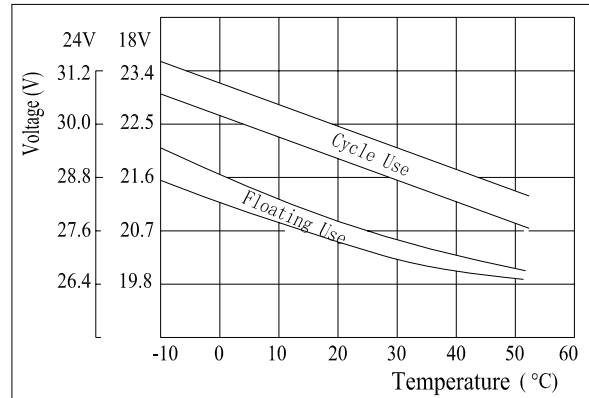

Floating Life on Temperature

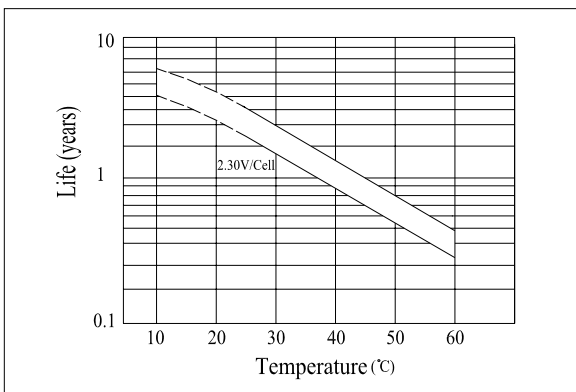

Cycle Life on D.O.D(25°C)

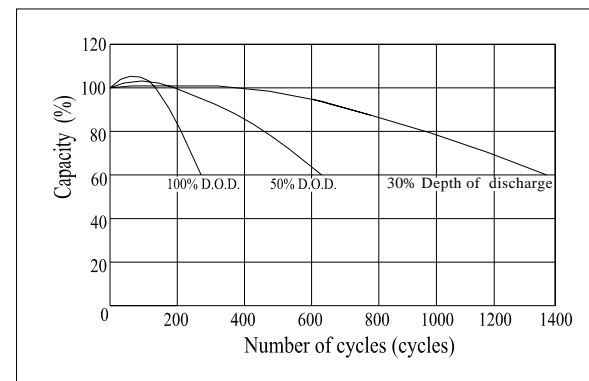

Charging Characteristics(25°C)