

**Specifications**

Nominal Voltage		12 V
Capacity (25°C)	10HR(10.8V)	65 Ah
	5HR(10.5V)	57Ah
	1HR(9.60V)	40.7Ah
Dimension	Length	350±2mm (13.78inch)
	Width	167±2mm (6.57inch)
	Height	179±2mm (7.05inch)
	Total Height	T5: 186±2mm (7.32inch) T9: 179±2mm (7.05inch)
Approx. Weight		20.8kg (45.9lbs)±4%
Terminal type		T5/T9
Internal resistance (Fully charged, 25°C)		Approx. 6mΩ
Capacity affected by temperature (10HR)	40°C	102%
	25°C	100%
	0°C	85%
	-15°C	65%
Self-discharge (25°C)	3 month	Remaining Capacity: 91%
	6 month	Remaining Capacity: 82%
	12 month	Remaining Capacity: 65%
Nominal operating temperature		25°C ± 3°C (77°F ± 5°F)
Operating temperature range	Discharge	-15°C ~ 50°C (5°F ~ 122°F)
	Charge	-10°C ~ 50°C (14°F ~ 122°F)
	Storage	-20°C ~ 50°C (-4°F ~ 122°F)
Float charging voltage(25°C)		13.50 to 13.80V Temperature compensation: -18mV/°C
Cyclic charging voltage(25°C)		14.50 to 14.90V Temperature compensation: -30mV/°C
Maximum charging current		19.5A
Terminal material		Copper
Maximum discharge current		650A(5 sec.)
Designed floating life(20°C)		7~10 years

**Dimensions**

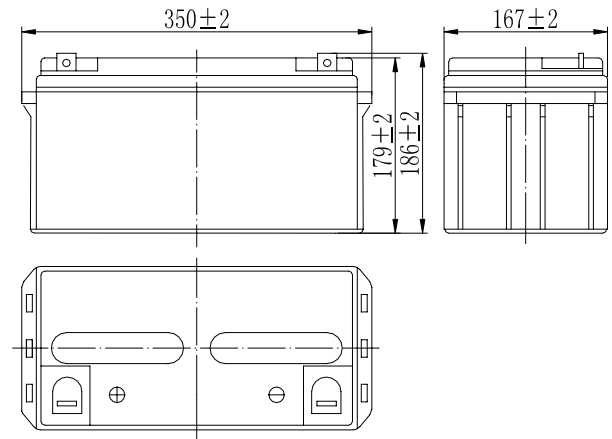

**Terminal**

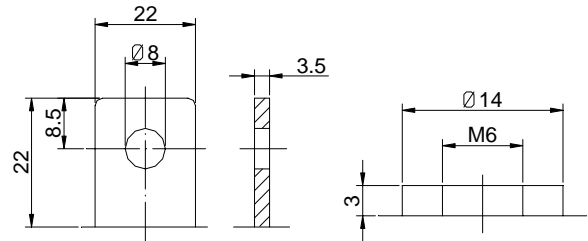

Terminal T5

Terminal T9

- ◆ Absorbent glass mat technology;
- ◆ Recognized by UL & CE;
- ◆ ABS container.

**Constant Current Discharge Characteristics (A, 25°C)**

F.V/TIME	10min	15min	30min	60min	2h	3h	4h	5h	8h	10h	20h
9.60V	139	108	65.7	40.7	23.8	16.6	13.6	11.6	7.96	6.62	3.47
9.90V	135	106	64.3	40.1	23.6	16.5	13.5	11.5	7.91	6.60	3.47
10.2V	129	102	62.4	39.1	23.4	16.4	13.4	11.5	7.85	6.58	3.46
10.5V	124	98.4	60.9	38.3	23.0	16.3	13.3	11.4	7.80	6.55	3.44
10.8V	117	93.2	58.6	37.1	22.5	15.8	12.9	11.0	7.57	6.50	3.41

**Constant Power Discharge Characteristics (Watt, 25°C)**

F.V/TIME	10min	15min	30min	60min	2h	3h	4h	5h	8h	10h	20h
9.60V	1504	1189	737	464	275	195	160	137	94.5	79.0	41.7
9.90V	1459	1161	722	457	273	194	159	136	94.0	78.9	41.6
10.2V	1398	1118	700	445	271	192	158	135	93.3	78.6	41.5
10.5V	1338	1080	683	437	267	191	157	134	92.7	78.2	41.2
10.8V	1263	1023	658	423	260	185	152	130	89.9	77.6	41.0

Note: The above characteristics data can be obtained within three charge/discharge cycles.

Discharge Characteristics(25°C)

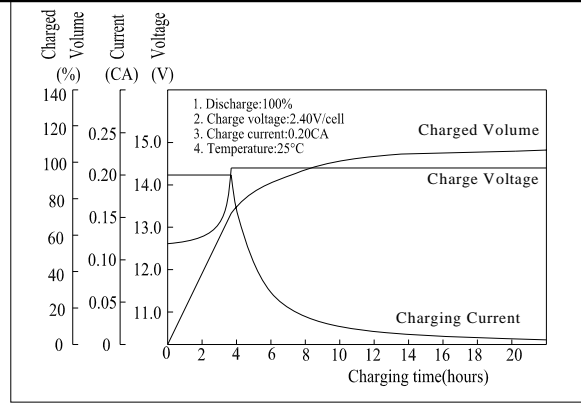
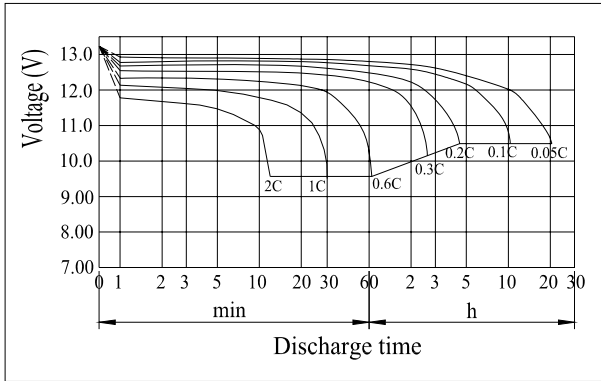

Effect of Temperature on Capacity

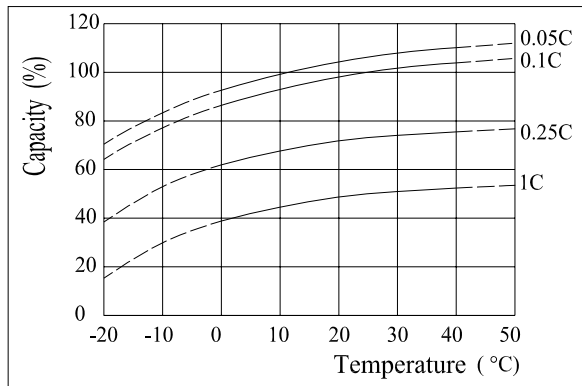

Self-discharge Characteristics

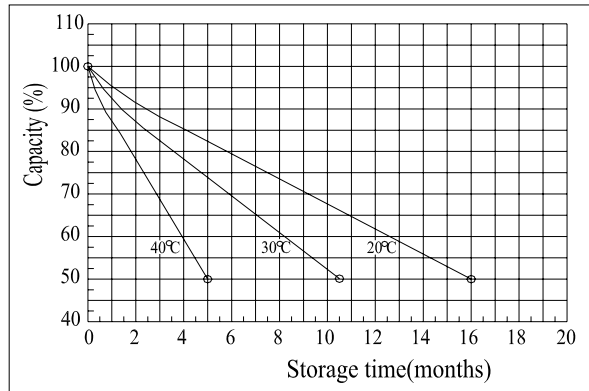

The Relationship for Open Circuit Voltage and Residual Capacity (25°C)

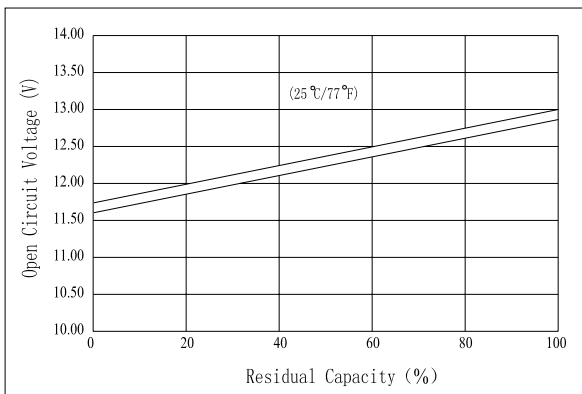

The Relationship for Charging Voltage and Temperature

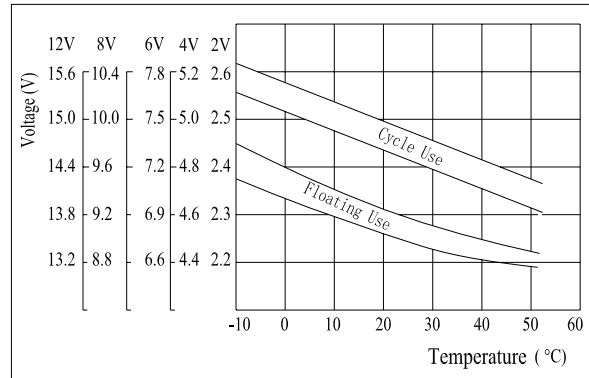

Floating Life on Temperature

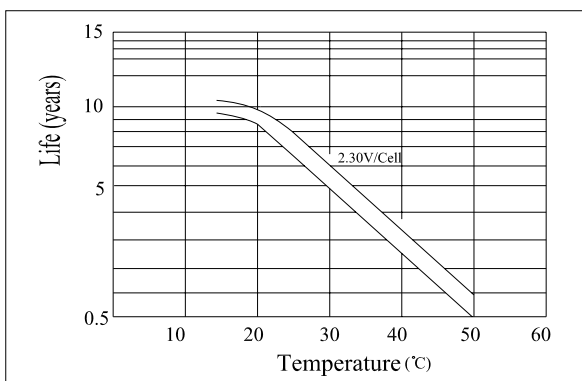

Cycle Life on D.O.D(25°C)

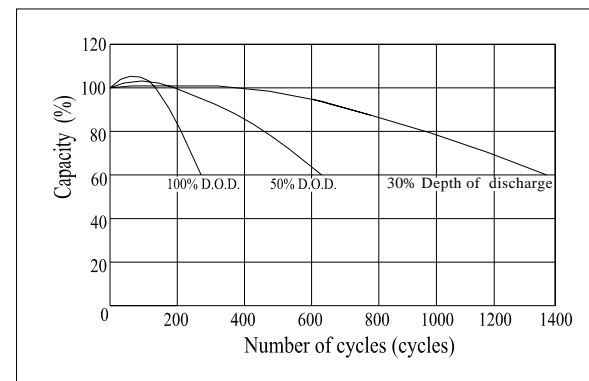

Charging Characteristics(25°C)