

Specifications

Nominal Voltage		2 V
Capacity (25°C)	10HR(1.80V)	150 Ah
	3HR(1.75V)	114.7Ah
	1HR(1.60V)	90.0Ah
Dimension	Length	171 ± 2mm (6.73inch)
	Width	102 ± 1mm (4.02inch)
	Height	206 ± 2mm (8.11inch)
	Total Height	230 ± 2mm (9.06inch)
Approx. Weight		8.5kg (18.7lbs) ± 3%
Terminal type		T10
Internal resistance (Fully charged, 25°C)		Approx. 0.7m Ω
Capacity affected by temperature (10HR)	40°C	103%
	25°C	100%
	0°C	88%
	-15°C	70%
Self-discharge (25°C)	3 month	Remaining Capacity: 94%
	6 month	Remaining Capacity: 88%
	12 month	Remaining Capacity: 75%
Nominal operating temperature		25°C ± 3°C (77°F ± 5°F)
Operating temperature range	Discharge	-15°C ~ 55°C (5°F ~ 131°F)
	Charge	-10°C ~ 55°C (14°F ~ 131°F)
	Storage	-20°C ~ 55°C (-4°F ~ 131°F)
Float charging voltage(25°C)		2.25 to 2.30V Temperature compensation: -3mV/°C
Cyclic charging voltage(25°C)		2.35 to 2.40V Temperature compensation: -5mV/°C
Maximum charging current		30A
Terminal material		Copper
Maximum discharge current		800A(5 sec.)
Designed floating life(20°C)		20 years

- ◆ Gelled electrolyte technology;
- ◆ PVC separator;
- ◆ Recognized by UL & CE;
- ◆ ABS container.

Constant Current Discharge Characteristics (A, 25°C)

F.V/TIME	30min	60min	2h	3h	4h	5h	6h	8h	10h	20h	48h	120h
1.60V	128	90.0	54.8	39.0	31.4	27.3	23.4	18.3	15.3	8.01	---	---
1.65V	125	88.2	54.5	38.9	31.2	27.0	23.3	18.3	15.3	8.00	--	--
1.70V	122	86.4	54.0	38.6	30.9	26.9	23.1	18.2	15.2	7.98	3.66	---
1.75V	120	84.8	53.3	38.3	30.8	26.7	23.0	18.0	15.2	7.94	3.66	1.52
1.80V	116	82.1	51.9	37.1	29.9	26.0	22.2	17.4	15.0	7.88	3.63	1.50

Constant Power Discharge Characteristics (Watt, 25°C)

F.V/TIME	30min	60min	2h	3h	4h	5h	6h	8h	10h	20h	48h	120h
1.60V	239	171	106	76.5	61.5	53.7	46.1	36.6	30.5	16.1	---	---
1.65V	234	168	105	76.1	61.1	53.4	45.9	36.3	30.3	16.1	--	--
1.70V	230	164	104	75.5	60.8	53.0	45.6	36.0	30.3	15.9	7.46	---
1.75V	225	161	103	75.0	60.3	52.7	45.2	35.9	30.0	15.9	7.38	3.09
1.80V	218	156	100	72.8	58.5	51.0	43.8	34.8	29.9	15.8	7.34	3.08

Note: The above characteristics data can be obtained within three charge/discharge cycles.

Dimensions

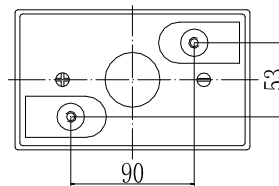
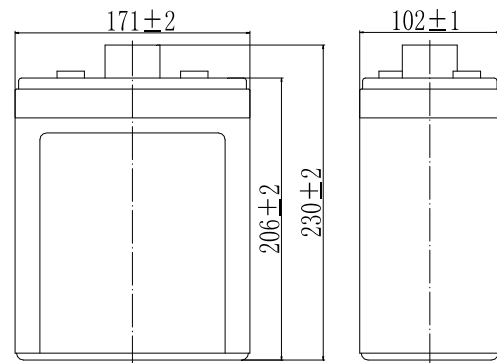

Terminal

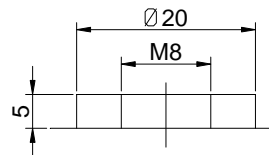

Terminal T10

Discharge Characteristics(25°C)

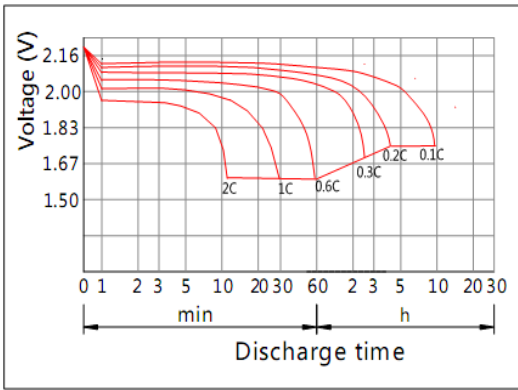

Charging Characteristics(25°C)

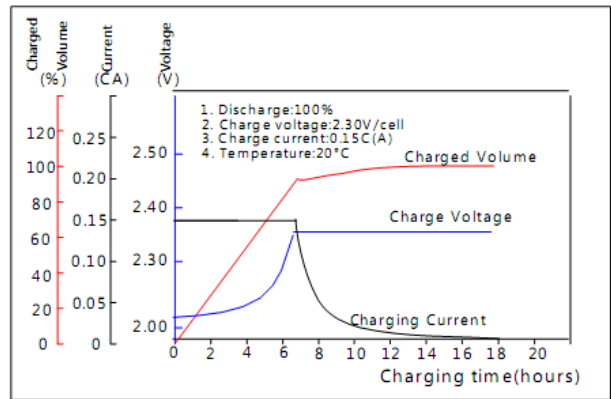

Effect of Temperature on Capacity

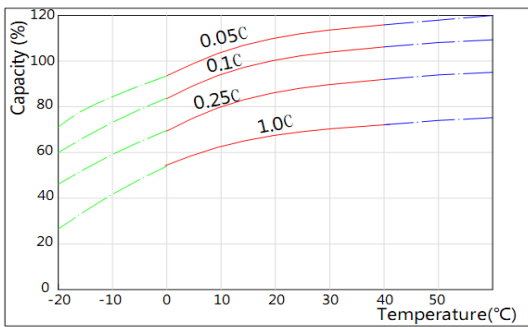

Self-discharge Characteristics

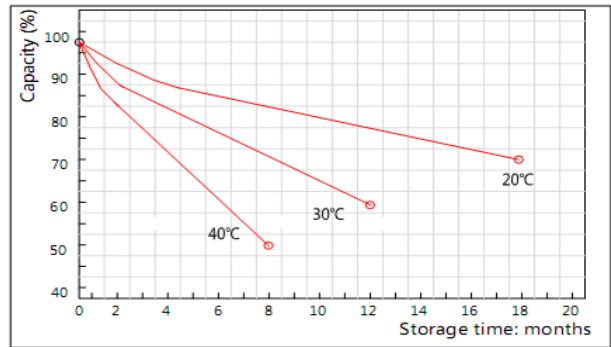

The Relationship for Open Circuit Voltage and Residual Capacity (25°C)

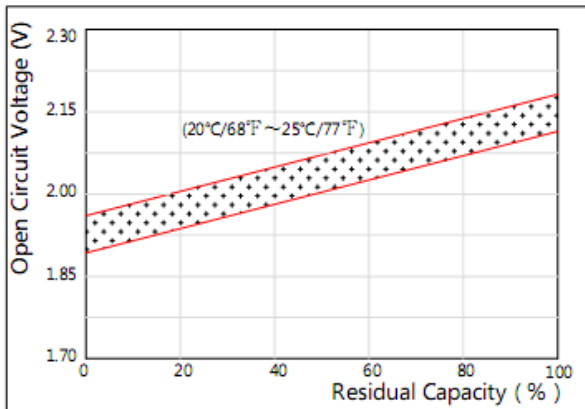

The Relationship for Charging Voltage and Temperature

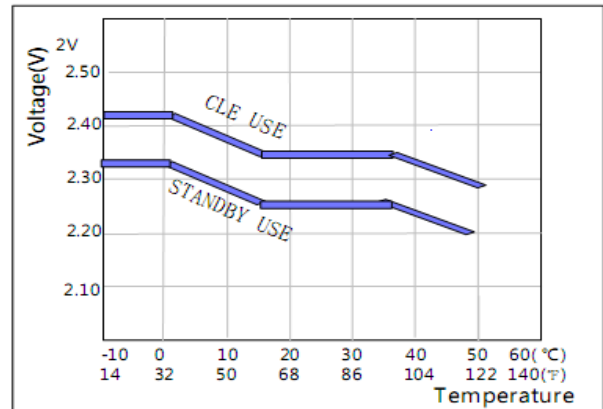

Floating Life on Temperature

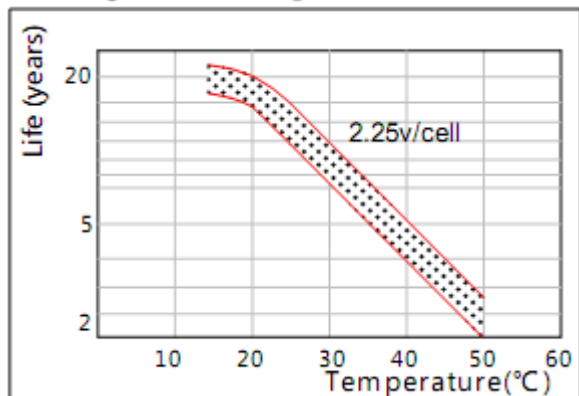

Cycle Life on D.O.D(25°C)

