

Specifications

Nominal Voltage		2 V
Capacity (20°C)	10HR(1.80V)	500 Ah
	3HR(1.75V)	382Ah
	1HR(1.60V)	280Ah
Battery Weigh	Dry	26kg 57.2lbs)±5%
	Wet	36kg (79.2lbs)±5%
Acid Weight (d=1.24kg/l)		Approx.10kg (22.0lbs)
Terminal type /material		T10 / Copper
Internal resistance (Fully charged, 25°C)		Approx. 0.7 mΩ
Self-discharge	1 month	Remaining Capacity: 86%(20°C)
Nominal operating temperature		20°C±5°C (68°F±9°F)
Operating temperature range	Discharge	-15°C~50°C(5°F~122°F)
	Charge	10°C~45°C(50°F~113°F)
	Storage	10°C~30°C(50°F~86°F)
Initial charging	Constant current	Charge the battery at 0.05 C ₁₀ for 72h.
	Constant voltage	Charge the battery at 0.1 C ₁₀ to 2.35v/cell; then Charge the battery with 2.35v/cell until the whole charge time up to 100h.
Mark of Fully charged	Constant current	The battery voltage and density of electrolyte remain stable over 2h at the end of charging , and strong bubbles generated within the electrolyte
	Constant voltage	The charging current and density of electrolyte kept constant for more than 3h at the end of the charge; and the charging current is about 0.002~0.005 C ₁₀ amp.
Supplementary charge		Charge the battery at 0.05 C ₁₀ to fully charged.
Equalizing charging		Charge the battery with 2.40v/cell for 48h.
Battery operation	Float charging	Charge the battery with 2.23V (25°C); Equalizing charging the battery when the abnormal occurs
	Charge& discharge	Equalizing charging the battery after discharged and per 3months
	Backup	Supplementary charge the battery per 3 or 6 months.
Maximum charging current		125A(0.25C ₁₀)
Max. discharge current		2500A(5 sec.)
Designed cycle life		1600@80% DOD (30°C)
Designed floating life		20 years(20°C)

CHARACTERISTICS:

- ◆ Tubular Positive Plate;
- ◆ Flooded Battery;
- ◆ Porous Rubber and Porous PVC Separator
- ◆ Transparent Container.

Dimensions

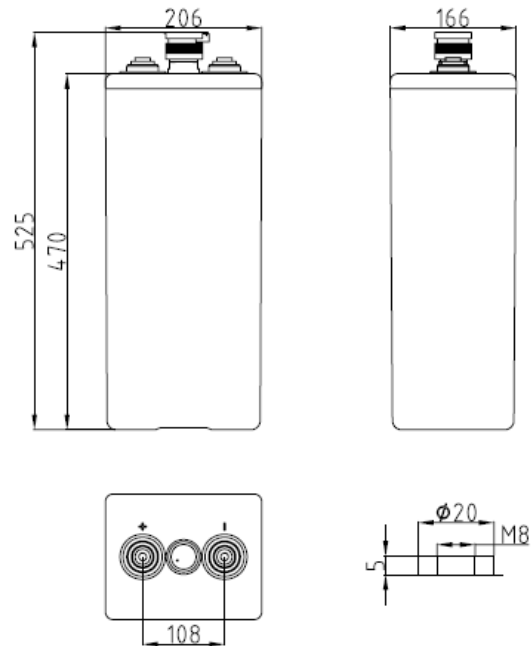

Constant Current Discharge Characteristics (A, 25°C)

F.V/TIME	30min	60min	2h	3h	4h	5h	6h	8h	10h	20h	24h	48h	120h
1.70V	390	270	165	129	103	90.6	77.0	59.0	50.6	27.2	23.8	----	----
1.75V	380	262	163	128	103	90.0	76.6	58.6	50.6	27.2	23.6	----	----
1.80V	366	256	159	124	99.6	87.6	74.0	56.6	50.0	27.0	23.6	12.1	----
1.85V	346	240	149	116	93.6	82.6	69.6	53.0	47.6	25.8	22.4	12.1	5.00

Constant Power Discharge Characteristics (Watt, 25°C)

F.V/TIME	30min	60min	2h	3h	4h	5h	6h	8h	10h	20h	24h	48h	120h
1.70V	728	510	318	252	202	179	152	117	101	54.6	47.8	----	----
1.75V	710	500	312	250	202	178	151	116	100	54.6	47.6	----	----
1.80V	686	486	306	242	195	172	146	113	99.6	54.0	47.2	24.4	----
1.85V	638	450	286	226	182	160	136	105	92.6	50.0	45.0	24.4	10.2

Note: The above characteristics data can be obtained within three charge/discharge cycles.

Discharge Characteristics(25°C)

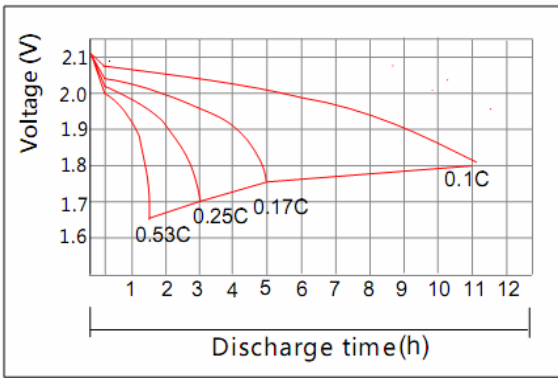

Initial Charging (CC) Characteristics(25°C)

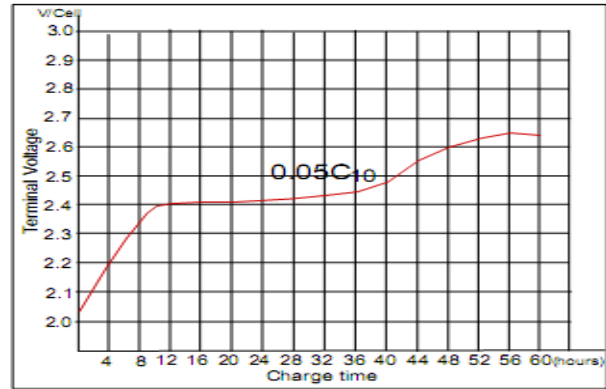

Effect of Temperature on Capacity

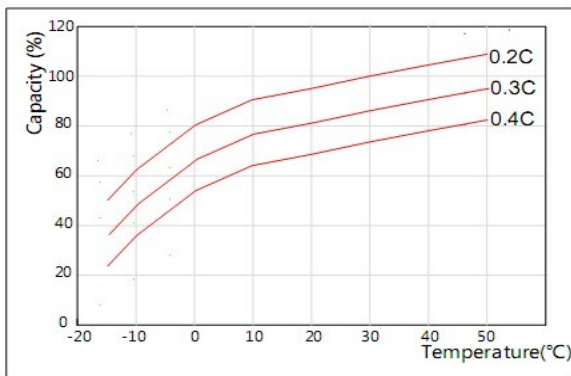

Initial Charging (CV) Characteristics

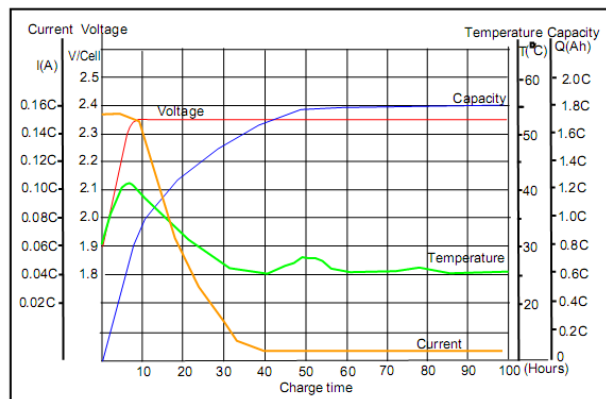

The Relationship for Open Circuit Voltage and Residual Capacity (25°C)

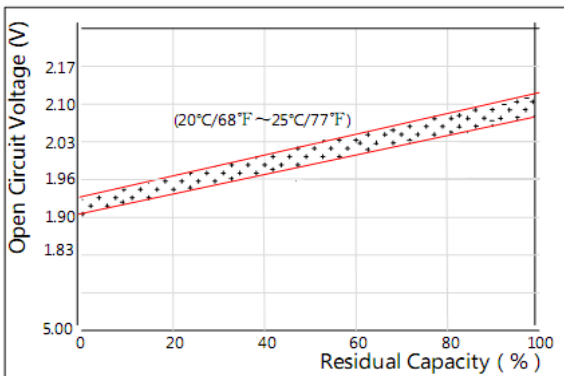

Supplementary charge (CV) Characteristics

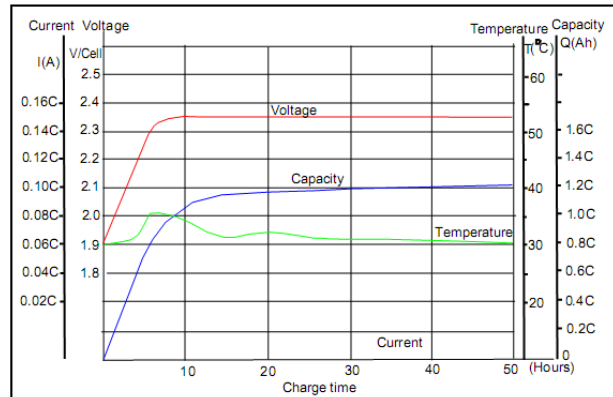

Effect of Discharge rate on Capacity

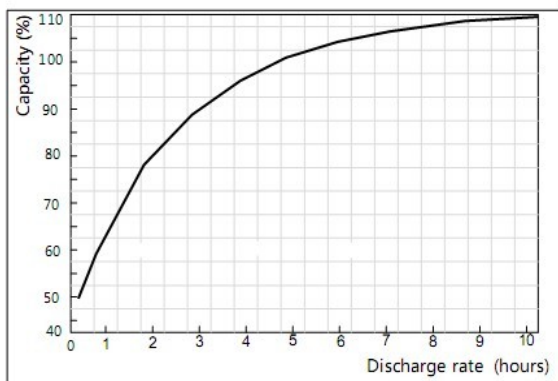

Cycle Life on D.O.D(25°C)

