

### General features for MPb Series (AGM) battery

- \* Stable quality & high reliability.
- \* Unique construction and sealing technique guarantees.
- \* Design life 10years in float service;the battery comply to the most popular international standards,like IEC60896-21/22,etc
- \* Maintenance-free operation.
- \* UL-recognized component.
- \* Heavy duty grids:  
The heavy-duty lead calcium-alloy grids ,provide an extra margin of performance and service life in float & cyclic.
- \* Case and cover are available in both standard and flame retardant ABS.
- \* Low self discharge;low pressure venting system.



**Maxton Power Tech Co.,Ltd**  
www.maxtonpower.com  
info@maxtonpower.com

**MP12-40 (12V40Ah)**

### Specifications

Nominal Voltage		12V	
Rated capacity (10 hour rate)		40Ah	
Dimensions (±2mm)	Total Height	T16	171 mm (6.73 inches)
		T9	171 mm (6.73 inches)
	Height	171 mm (6.73 inches)	
	Length	197 mm (7.73 inches)	
	Width	166 mm (6.54inches)	
Weight Approx (±3%)		12.5Kg (27.5 lbs)	

### Battery picture and construction



#### Battery Construction

Component	Positive plate	Negative plate	Container	Cover
Raw material	Lead dioxide	Lead	ABS	ABS
Component	Electrolyte	Separator	Safety valve	Terminal
Raw material	Dilute sulfuric acid	Fiberglass	Rubber	Copper

### Outer dimension and terminal

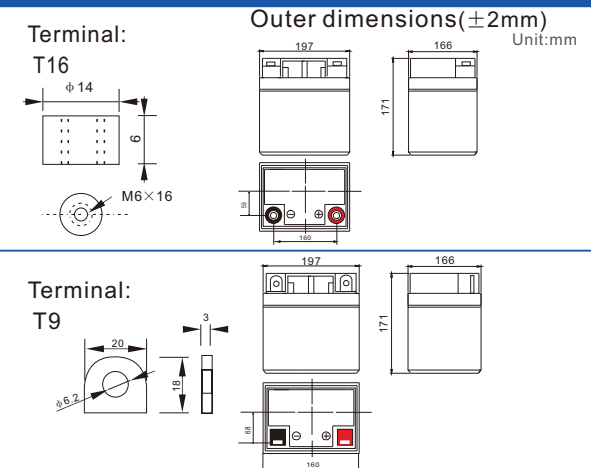

### Characteristics

Capacity 25°C(77°F)	10 hour rate(4A, 10.5V) 5 hour rate(6.4A, 10.5V) 1 hour rate(24A, 9.6V)	40Ah 32Ah 24Ah
Internal Resistance	Full charged battery at 25°C(77°F)	Approx 8.5 mΩ
Capacity affected by Temperature (20hour rate)	40°C (104°F) 25°C (77°F) 0°C (32°F) -15°C (5°F)	102% 100% 85% 65%
Remaining capacity Self-Discharge At 25°C(77°F)	Capacity after 3 month storage Capacity after 6 month storage Capacity after 12 month storage	91% 82% 64%
Terminal type	T16 (Option T9)	
Max. Discharge current 25°C/(77°F)	400A (5Seconds)	
Nominal operating temperature	25°C ±5°C(77°F ±9°F)	
Operating Temperature Range	Discharge Charge Storage	-15°C ~50°C (5°F ~122°F) -10°C ~50°C (14°F ~122°F) -20°C ~50°C (-4°F ~122°F)
Charge methods (constant Voltage) At 25°C(77°F)	Cycle use Standby use	Initial Charging Current less than 10A Voltage 14.5-14.9V Temperature compensation:-30mV/°C Voltage 13.5-13.8V Temperature compensation:-18mV/°C

### Constant current discharge (25°C , 77 °F)

Unit:A

### Constant power discharge (25°C , 77 °F)

Unit:watts

Time		5min	10min	15min	30min	1h	2h	3h	4h	5h	8h	10h	20h
9.60V	A	128	84	68	45.6	24	14	10.3	8	6.6	4.68	4.2	2.27
	W	1322	901	730	490	259	154	114	90	75	54	49	26.4
10.20V	A	124	76	64	43.6	22.6	13.4	10	7.8	6.5	4.56	4.12	2.2
	W	1325	850	717	489	255	154	11.6	91	76	53	48	25.8
10.50V	A	120	68	56	40.8	21.8	13	9.8	7.7	6.4	4.52	4.04	2.2
	W	1311	775	640	470	253	151	114	90	75	53	48	26
10.80V	A	116	64	52	37.6	21.1	12.7	9.5	7.6	6.2	4.4	4.0	2.16
	W	1298	740	600	436	246	149	112	89	74	52	48	25.7
11.10V	A	112	60	48	33.6	20.4	12.4	9.2	7.4	6.1	4.28	3.8	2.04
	W	1268	697	560	393	240	147	109	88	73	51	45.9	24.7

(Above characteristics data are average values obtained within three charge/discharge cycles,not the minimum values.)

# VRLA Battery (AGM technology) Maintenance-free Sealed Lead Acid Rechargeable Battery

## Discharge characteristics (25°C, 77°F)

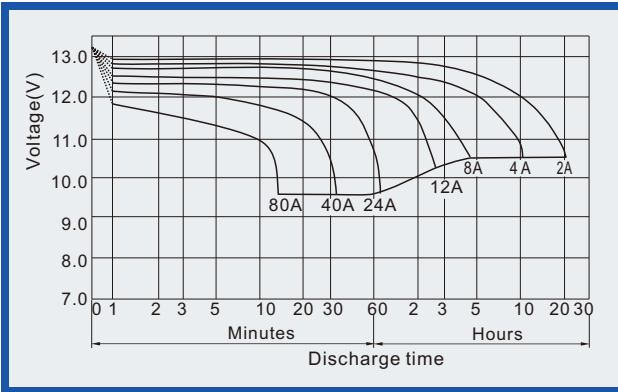

## Charge characteristics (25°C, 77°F)

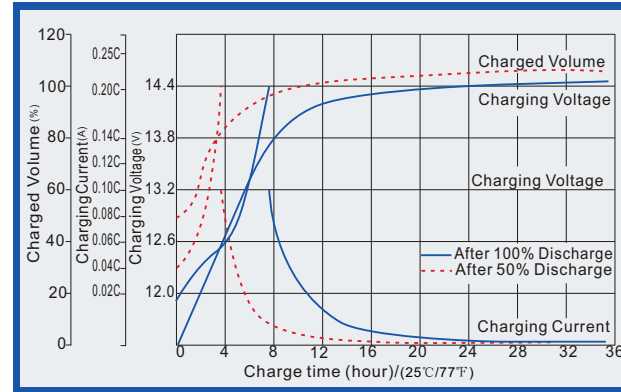

## Life characteristics of Cyclic Use (25°C, 77°F)

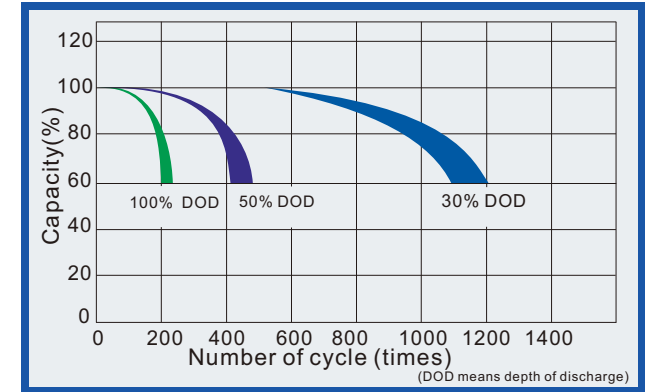

## Effect of Temperature on capacity

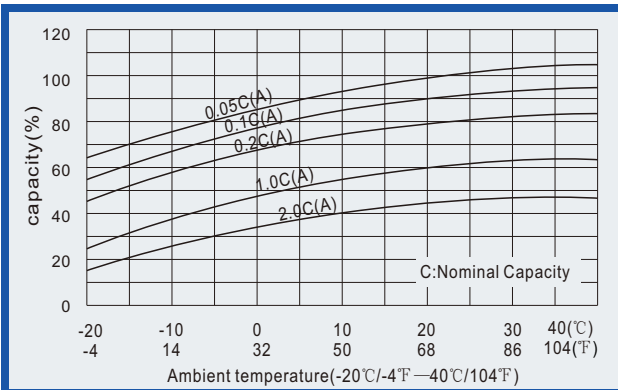

## Self-discharge characteristics

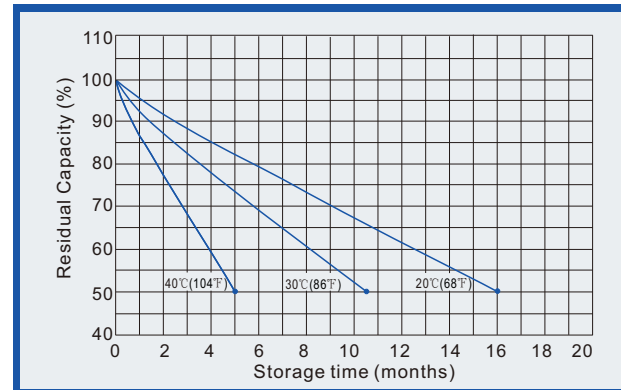

## Life Characteristics of float service (25°C, 77°F)

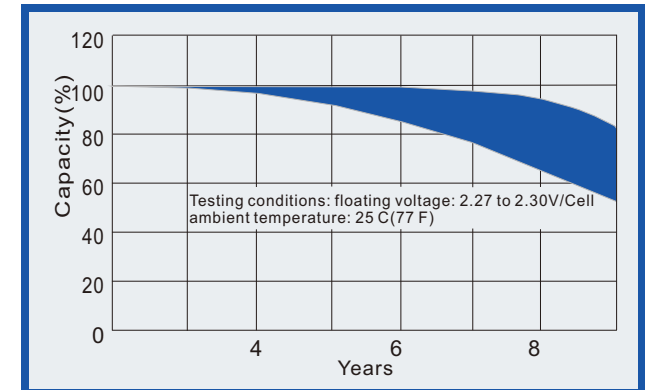

## Relationships for open voltage and remained capacity (for reference)

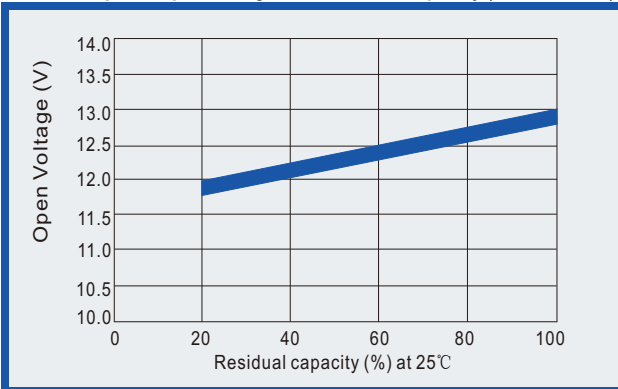

## Relationship for charging voltage and temperature

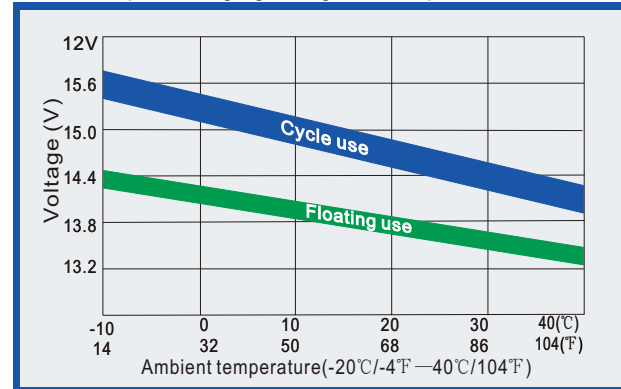

## Temperature effects on floating life

