

Valve Regulated Deep Cycle Battery

GPD100-12A 12V 100AH

Specifications

Nominal Voltage	12V	
Rated capacity (10 hour rate)	100Ah	
Dimensions	Length	306 ± 2mm(12.05inch)
	Width	169 ± 2mm(6.65inch)
	Height	208 ± 2mm(8.19inch)
	Total Height	230 ± 2mm(9.06inch)
Approx. Weight	27.5kg(60.61lbs) ± 3%	



Outer dimensions (mm)

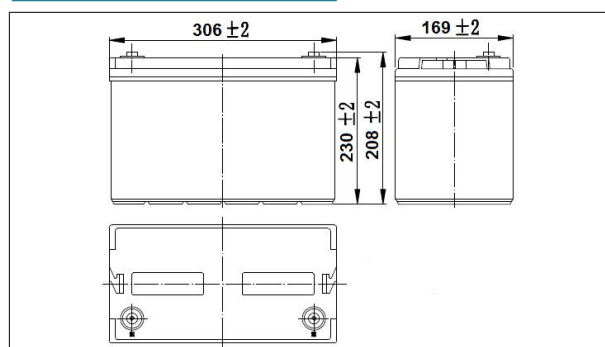

Terminal Type (mm)

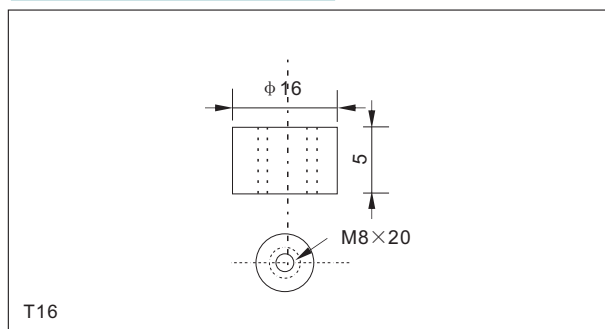

Characteristics

Capacity (25°C)	10HR(10.8V)	100Ah
	3HR(10.8V)	75Ah
	1HR(10.5V)	58.6Ah
Terminal type		T16
Internal resistance (Fully charged, 25°C)		Approx. 4.5m Ω
Capacity affected by temperature (20HR)	40°C	102%
	25°C	100%
	0°C	85%
	-15°C	65%
Self-discharge (25°C)	3 months	Remaining Capacity: 91%
	6 months	Remaining Capacity: 82%
	12 months	Remaining Capacity: 65%
Nominal operating temperature		25°C ± 3°C (77°F ± 5°F)
Operating temperature range	Discharge	-15°C ~ 50°C (5°F ~ 122°F)
	Charge	-10°C ~ 50°C (14°F ~ 122°F)
	Storage	-20°C ~ 50°C (-4°F ~ 122°F)
Float charging voltage(25°C)		13.50 to 13.80V Temperature compensation: -18mV/°C
Cyclic charging voltage(25°C)		14.50 to 15.00V Temperature compensation: -30mV/°C
Maximum charging current		30A
Maximum discharge current		800A(5 sec.)
Designed floating life(20°C)		10years

Construction

Component	Positive plate	Negative plate	Container	Cover	Separator	Electrolyte	Safety valve	Terminal
Raw material	Lead dioxide	Lead	ABS	ABS	AGM	Sulfuric acid	Rubber	Copper

Constant Current Discharge Characteristics Unit:A(25°C, 77°F)

F.V/Time	10min	15min	30min	60min	2h	3h	4h	5h	8h	10h	20h
9.60V	222	171	103	63.0	37.3	26.7	21.4	18.3	12.6	10.4	5.50
9.90V	216	167	100	62.1	37.1	26.5	21.3	18.2	12.5	10.4	5.49
10.2V	207	161	97.4	60.5	36.7	26.3	21.2	18.1	12.4	10.3	5.48
10.5V	198	156	95.0	58.6	36.2	26.1	21.0	18.0	12.3	10.2	5.44
10.8V	187	147	91.5	56.7	35.3	25	20.4	17.4	12.0	10	5.41

Constant Power Discharge Characteristics Unit:W(25°C, 77°F)

F.V/Time	10min	15min	30min	60min	2h	3h	4h	5h	8h	10h	20h
9.60V	2401	1882	1150	719	432	316	252	216	150	124	66.0
9.90V	2329	1836	1127	708	429	314	251	215	149	124	65.9
10.2V	2233	1769	1093	690	425	312	249	214	148	123	65.7
10.5V	2137	1708	1066	668	419	309	247	212	147	123	65.3
10.8V	2017	1618	1027	647	408	300	240	206	142	122	64.9

Note: The above characteristics data can be obtained within three charge or discharge cycles.

Valve Regulated Deep Cycle Battery

GPD100-12A 12V 100AH



Discharge characteristics(25°C)

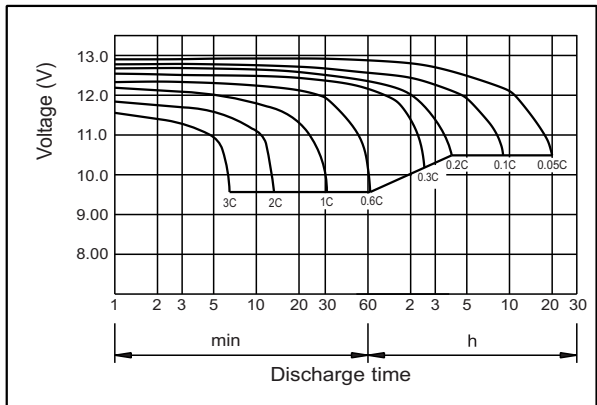

Charging characteristics (25°C)

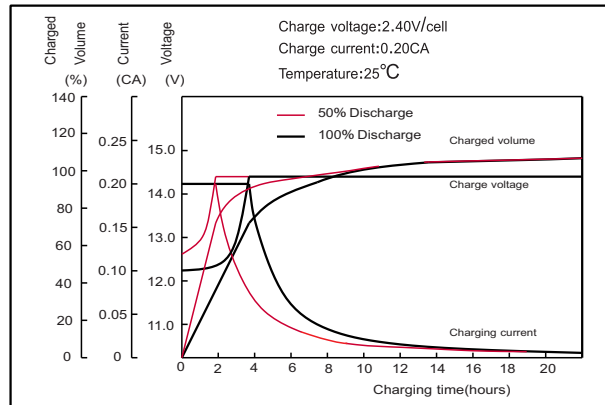

Temperature effects on Capacity

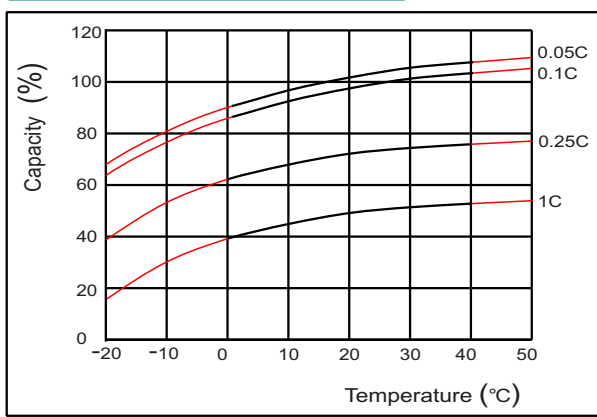

Self-discharge characteristics

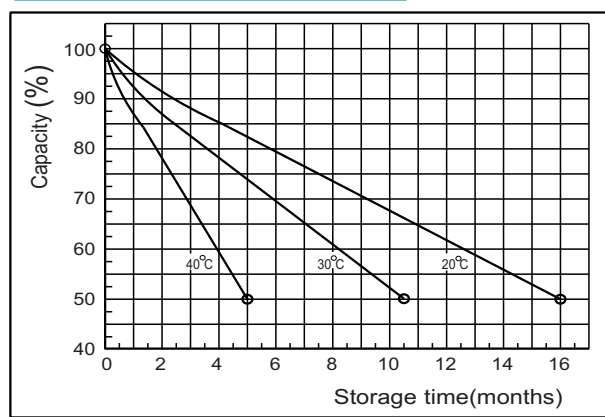

Floating life on Temperature

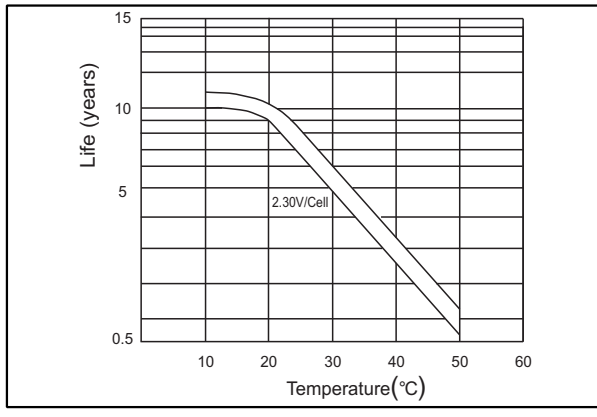

Cycle life on D.O.D (25°C)

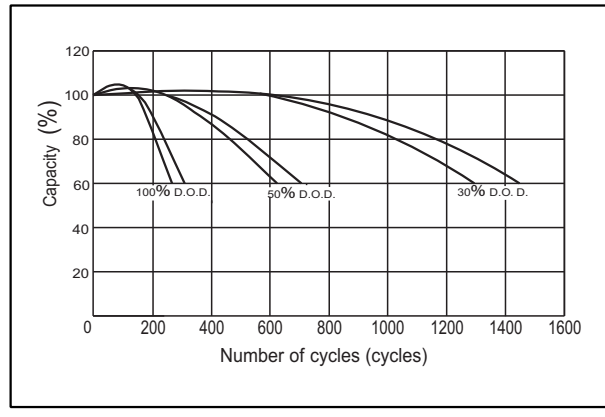

The relationship for OCV and Capacity (25°C)

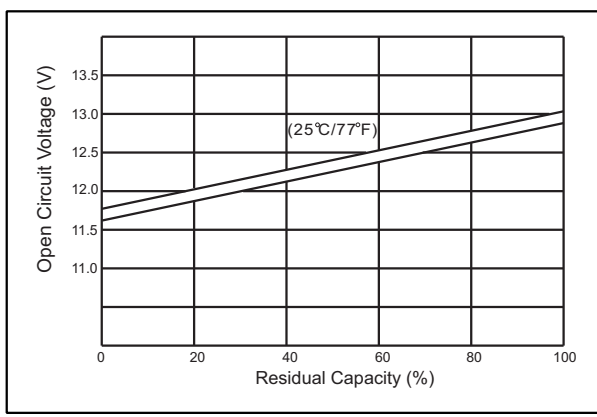

The relationship for Charging voltage and Temperature

