

Panda

Residential Single-phase Energy Storage System Panda Series

Panda 3680S~6000S-5HP~30HP



ZONERGY



The 5 kWh module adopted enables variable capacity range of 5-30 kWh.



The switching time between on-off grid less than 10 ms secures Uninterruptable Power Supply for the load.



The Lithium Iron Phosphate (LFP) cell secures safe and reliable operation.



The automatic isolation of the faulty battery module secures smooth system operation.



The APP-based remote monitoring offers easy maintenance and unlimited function expansion.









The built-in Smart Grid Management module enables power grid dispatching.



The Degree of Protection at IP66 makes it suitable for various harsh environments for application.

Panda 3680S~6000S-5HP~30HP Technical parameters

Technical parameters:	Panda 3680S1-5HP	Panda 3680S1-10HP	Panda 3680S1-15HP	Panda 3680S1-20HP	Panda 3680S1-25HP	Panda 3680S1-30HP
	Panda 4000S1-5HP	Panda 4000S1-10HP	Panda 4000S1-15HP	Panda 4000S1-20HP	Panda 4000S1-25HP	Panda 4000S1-30HP
System Demo						

System Specification							
Nominal Output Power	3680 W	4000 W	4600 W	5000 W	6000 W	3680 W	4000 W
Capacity Range	5.12~30.72 kWh						
Usable Capacity Range	4.6~27.65 kWh						
Battery Chemistry	LFP (LiFePO4)						
IP Protection	IP66 (Outdoor)						
Warranty	5 Year Product Warranty						

Inverter Technical Specification							
Model	Venus 3680-S1	Venus 4000-S1	Venus 4600-S1	Venus 5000-S1	Venus 6000-S1	Venus 3680-S2	Venus 4000-S2
Phase	Single Phase						
Max. PV Input Voltage	600 V						
MPPT Voltage Range	100 V~550 V						
Max. PV Input Current	16 A / 16 A			16A			
Max. PV Input Power	8000 W	9000 W	9000 W	9000 W	9000 W	4500 W	4500 W
Max. MPPT Short-circuit Current	20 A / 20 A			20A			
Number of Independent MPPT	2					1	
Start-up Voltage Range	120 V						
Max. Charging/Discharging Current	100 A						
Max. Charging/Discharging Power	5000 W						
Output Voltage Range on Grid	180 ~ 276 V						
Rated Grid Output Frequency on Grid	50 Hz/60 Hz						
Grid-tied Output Power	3680 W	4000 W	4600 W	5000 W	6000 W	3680 W	4000 W
Nominal AC Output Voltage	230 V						
Communication	CAN2.0/RS485, WIFI/4G(optional)						
Display	LCD & APP						
Dimension(W*H*D) mm	540 x 450 x 185						
Certification	EN IEC62109-1, EN IEC62109-2, IEC61683, IEC61727, IEC62116, IEC60068, EN IEC61000-6-1, EN IEC61000-6-3, IEC60529 IP66, EN50549-1, EN50530, Italy CEI 0-21, Germany VDE4105, UK G98, G99, Spain UNE217001, UNE217002, NTS 2.1, RoHS(2011/65/EU+2015/863), WEEE(2012/19/EU), ISTA, UKCA						

Battery Technical Specification						
Module Model	Limestone 5H-P	Limestone 10H-P	Limestone 15H-P	Limestone 20H-P	Limestone 25H-P	Limestone 30H-P
Module Capacity	5.12 kWh	10.24 kWh	15.35 kWh	20.48 kWh	25.64 kWh	30.72 kWh
Usable Capacity	4.6 kWh	9.21 kWh	13.81 kWh	18.43 kWh	23.04 kWh	27.65 kWh
Nominal Voltage	51.2 V					
Max. Charging/Discharging Power	2.5 kW	5 kW	5 kW	5 kW	5 kW	5 kW
Operating Temperature Range	-20 ~ +50 °C					
Dimension(W*H*D) mm	650 x 620 x 180	650 x 980 x 180	650 x 1340 x 180	650 x 980 x 180 650 x 980 x 180	650 x 1340 x 180 650 x 980 x 180	650 x 1340 x 180 650 x 1340 x 180
Certification	IEC62619, IEC63056, EN IEC61000-6-1, IEC61000-6-3, EN IEC62040-1, EN IEC62477-1, IEC60730-1 Annex H, IEC60529 IP66, UN38.3, MSDS, RoHS(2011/65/EU+2015/863), WEEE(2012/19/EU), ISTA					

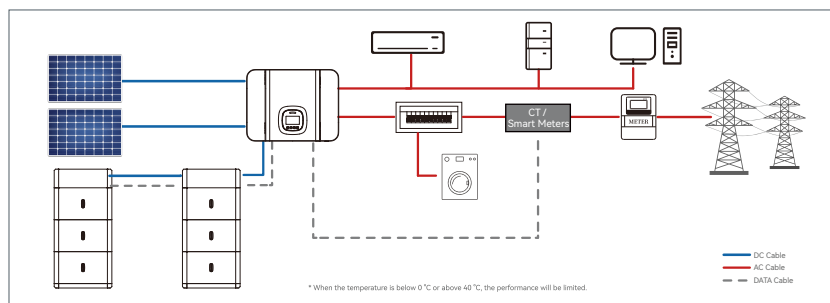

Note: Technical parameters listed hereunder are for reference only. Actual parameters shall be subject to products shipped.