



GEB 51.2V 100Ah LIFEPO4 BATTERY PACK USER MANUAL

Please read this manual carefully before operating
and retain it for future reference.



Functions	Configuration
External switch	Y
Current limiting	Y
Display screen	Y
Data storage	Y
Pre-charging	Y
Communication	CAN
Multi-trip	Y

CONTENT

1. Introduction	3
2. Function	3
3. Product Information	5
4. Communication	16
4.2 RS485	17
4.3 Parallel Communication	18
4.4 DIP Address	18
5. Working Mode	19
6. Indicators	20
6.1 LED Indicator Introduction	20
6.2 Capacity Light	21
6.3 Indicator Blinking Type	22
6.4 Indicator Status	21
7. Installation	22
7.1 Cargo List	22
7.2 Installation Environment	23
7.2.1 Check Battery Status	23
7.2.2 Installation Positioning	23
7.2.3 Wiring	24
8. Packing	28
9. Safety precaution	29

1. Introduction

The 51.2V 100Ah battery system is applicable to home energy storage, small or medium sized shopping mall energy storage, which uses 16 pieces of 3.6V 100Ah battery cells in 16s1p configuration. Built-in GEB smart BMS support maximum of 16 packs of battery in parallel to achieve higher capacity. The system can not be connected in series. And do not mix use a GEB battery with any other battery brands or models.

2. Function

- C14-cell battery voltage sampling test, with deviation of $\pm 20\text{mV}$.
- Battery and ambient temperature detection: 4 battery temperature sensors, 1 ambient temperature sensor, and 1 MOS temperature sensor, with a deviation of $\pm 2^\circ\text{C}$.
- Battery capacity and cycles: Complete a full charge/discharge cycle to set the actual capacity. The remaining capacity of the battery is monitored with a capacity estimation accuracy within 5% deviation. Additionally, charge and discharge cycle times as well as full charge and discharge cycle times are configurable.
- Intelligent cell balancing: The charging and static balancing strategies can be set flexibly to effectively extend the service life.
- Communication port: PC or smart front-end can monitor battery pack data, control operation and set parameters through commands such

as telemetry, remote signaling, remote adjustment, and remote control. The communication protocol conforms to the requirements of YD/T 1363.3, and realizes cascade communication at the same time.

- History data recording, saving and reading: Battery condition and alarm information will be recorded and save in real time when there is abnormality in the battery. A maximum of 500 history failure data can be stored.
- Battery management system parameter setting: Battery management system parameters includes cell over-voltage/under-voltage, battery total voltage over-voltage/under-voltage, charging/discharging over-current, battery high/low temperature, battery capacity, working mode, charging/discharging current limiting and so on. They can be set in the battery monitor system.
- Working mode: Working modes including charging/discharging current limiting, fixed voltage output, direct output and so on.
- Multiple protection functions: Hardware protection, battery protection, high/low temperature protection, output short-circuit protection and so on.

3. Product Information

3.1 Dimension and Port

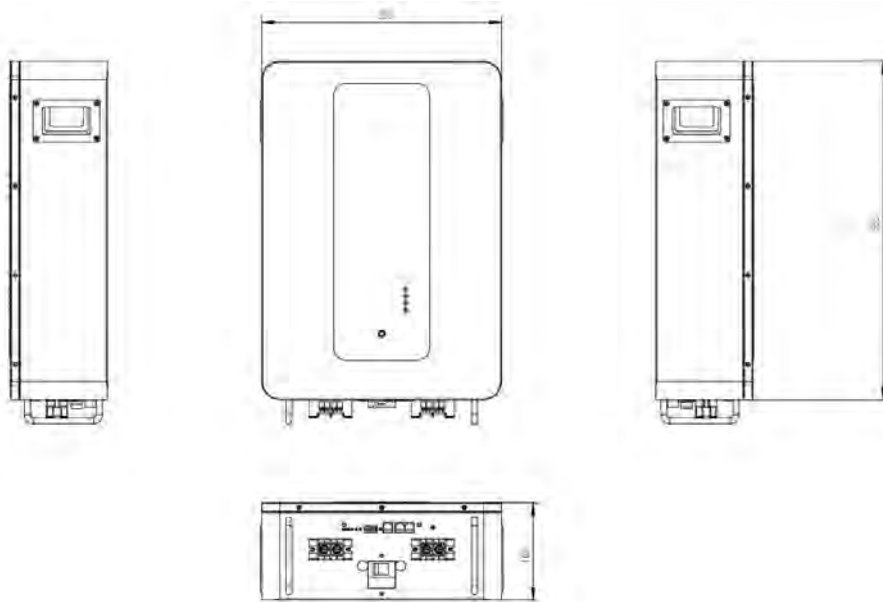

3.2 Electrical Schema

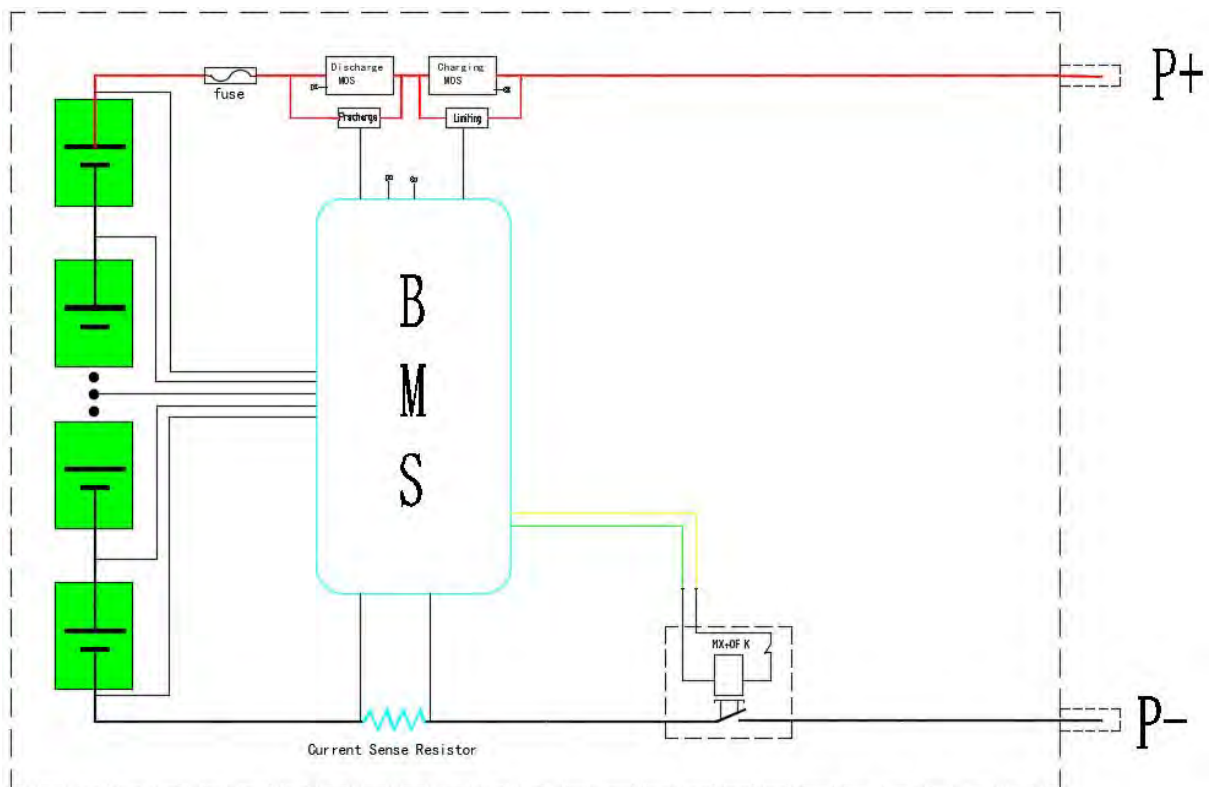

3.3 Battery Performance Parameter

No.	Project	Specification
1	Battery Configuration	1P16S
2	Nominal Voltage	51.2V
3	Working Voltage Range	42V~58.4V
4	Nominal Capacity	100Ah
5	Nominal Power	5.12KWh (95%DOD)
6	Standard Charging/Discharging Current	50A @25±2°C
7	Maximum Charging Current	100A@25±2°C
8	Maximum Discharging Current	100A @25±2°C
9	Working Ambient Temperature	0 ~ 40°C (Charge)
		-10 ~ 40°C (Discharge)
10	Storage Temperature & Humidity	-10°C~35°C (within 1 month storage) 25±2°C (within 3 months storage) 65%±20%RH
11	Size (L x W x H)	(563)×(399)×(162)mm
12	Weight	48Kg±3kg
13	Cycling Lifespan	4000 cycles @25°C 50A Charging/discharging current 80% DOD
18	IP Rate	IP 2X
19	Communication	CAN or RS485
20	Altitude	0-3000m
21	Humidity Range	5~80%

3.4 Battery Protection Parameter

Function Name	Function Setting	Function Setting	Setting Value	Setting Range
Setting Range	On	Cell high voltage alert	4200mV	Cell high voltage recovery~Cell over-voltage protection
		Cell high voltage recovery	4000mV	3000mV~Voltage of cell high-voltage
	On	Cell low voltage alert	3100mV	Cell under voltage protection~Cell low voltage recover
		Cell low voltage alert	3300mV	Cell low voltage alert~3300mV
Cell over-voltage protection	On	Cell over-voltage protection	4150mV	Cell high voltage alert~4500m
		Cell over-voltage recovery	4000mV	Cell high voltage recovery~Cell over-voltage voltage
		Over-voltage recovery condition	1. Cell voltage drops to over voltage recovery point 2. Residual capacity less than 96% of intermittent complementary capacity Recovery can only be made when two conditions are met	
			Battery discharging current detected>1A	
Battery discharging current detected>1A	On	Under voltage protection voltage	2900mV	1500mV~Cell under voltage recovery
		Under voltage recovery voltage	3300mV	Cell under voltage protection~Cell low voltage alert
		Cell under voltage turn-off	Turn off and maintain communication for 1 minute when under-voltage protection is triggered	
		Under voltage recovery condition	Charging current detected (>1A)	

Function Name	Function Setting	Function Setting	Setting Value	Setting Range
Battery total voltage alert	On	High total voltage alert	57.4V	High total voltage recovery~Over total voltage protection
		High total voltage recovery	56.0V	53.0V~Voltage of high total-voltage
	On	Low total voltage alert	43.4V	Under total voltage protection~Low total voltage recovery
		Low total voltage recovery	46.2V	Low total voltage alert~55.0V
Over total voltage protection	On	Over total voltage protection	58.0V	High total voltage alert~60.0V
		Over total voltage recovery	56.0V	High total voltage recovery~Voltage of over total-voltage
		Over-voltage recovery condition	1. Cell voltage drops to over voltage recovery point 2. Residual capacity less than 96% of intermittent complementary capacity Recovery can only be made when two conditions are met	
			Battery discharging current detected>1A	
Under total voltage protection	On	Under total voltage protection	40.6V	36.0V~Under total voltage recovery
		Under total voltage recovery	46.2V	Under total voltage protection~Low total voltage alert
		Under total voltage turn-off	Turn off and maintain communication for 1 minute when under-voltage protection is triggered	
		Under voltage recovery condition	Charging current detected (>1A)	

Function Name	Function Setting	Function Setting	Setting Value	Setting Range
Cell temperature and charging forbidden	On	Charging high temperature aler	50°C	Charging high temperature recovery~Charging over-temperature protection
		Charging high temperature recovery	47°C	35°C~Charging high temperature alert
		Charging over-temperature protection	55°C	Charging over-temperature recovery~80°C
		Charging over-temperature recovery	50°C	Charging high temperature recovery~Charging over-temperature protection
		Charging low temperature alert	2°C	Charging under temperature protection~Charging low temperature recovery
		Charging low temperature recovery	5°C	Charging low temperature alert~10°C
		Charging under temperature protection	-10°C	-20°C~Charging under temperature recovery
		Charging under temperature recovery	0°C	Charging under temperature protection~Charging low temperature recovery

Function Name	Function Setting	Function Setting	Setting Value	Setting Range
Cell temperature and charging forbidden	On	Charging high temperature alert	52°C	Charging high temperature recovery~Discharging over temperature protection
		Charging high temperature recovery	47°C	35°C~Charging high temperature alert
		Discharging over temperature protection	55°C	Discharging over temperature recovery~80°C
		Discharging over temperature recovery	50°C	Charging high temperature recovery~Discharging over temperature protection
		Discharging low temperature alert	-10°C	Discharging under temperature protection~Discharging low temperature recovery
		Discharging low temperature recovery	3°C	Discharging low temperature alert~10°C
		Discharging under temperature protection	-15°C	-30°C~Discharging under temperature recovery
		Discharging under temperature recovery	0°C	Discharging under temperature protection~Discharging low temperature recovery

Function Name	Function Setting	Function Setting	Setting Value	Setting Range
Ambient temperature protection	On	Ambient temperature alert	50°C	Ambient temperature recovery~Over ambient temperature protection
		Ambient temperature recovery	47°C	-20°C~Ambient temperature alert
		Over ambient temperature protection	60°C	Over ambient temperature recovery~80°C
		Over ambient temperature recovery	55°C	Ambient temperature recovery~Over ambient temperature protection
		Low ambient temperature aler	0°C	Under ambient temperature protection~Low ambient temperature recovery
		Low ambient temperature recovery	3°C	Low ambient temperature alert~60°C
		Under ambient temperature protection	-10°C	-30°C~Under ambient temperature recovery
		Under ambient temperature recovery	0°C	Under ambient temperature protection~Low ambient temperature recovery

Function Name	Function Setting	Function Setting	Setting Value	Setting Range
Power and temperature protection	On	Power high temperature alert	90°C	Power high temperature recovery~Power over temperature protection
		Power high temperature recovery	85°C	60°C~Power high temperature alert
		Power over temperature protection	100°C	Power high temperature alert~120°C
		Power over temperature recovery	85°C	Power high temperature recovery~Power over temperature protection
Charging current limiting	Off	Active current limiting	10A	Current limiting is on when charger current >10A
	On	Passive current limiting		Current limiting is on when charger current > over charging current alert (value is adjustable)
		Charging current limiting delay	5 minutes	When the current limiting is on, check after 5 minutes whether to have current limiting
Over charging current alert	On	Over charging current alert	100A	Over charging current recovery~Over charging current protection
		Over charging current recovery	95A	0A~Over charging current alert

Function Name	Function Setting	Function Setting	Setting Value	Setting Range
Over charging current protection	On	Over charging current protection	110A	0A~150A
		Over charging current delay	10S	Adjustable
		Over current recovery condition	Charging recovers immediately or recovers automatically in 60s	
Effective charging current	Minimum starting charging current		1000mA	
	Maximum exiting charging current		700mA	
Over discharging current alert	On	Over discharging current alert	-105A	Over discharging current protection~Over discharging current recovery
		Over discharging current recovery	-103A	Over discharging current alert~0A
Over discharging current alert~0A	On	Over discharging current protection	-110A	Instant over current protection~0A
		Over discharging current delay	10S	Adjustable
		Over current recovery condition	Charging recovers immediately or recovers automatically in 60s	
Instant over current protection	On	Instant over current protection	-220A	Over discharging current protection~300A
		Instant over current delay	30mS	Adjustable
		Instant over current recovery	Charging recovers immediately or recovers automatically in 60s	
	Off	Instant over current lock-down	Repeated 2 degree over current and exceeding over-current locking times	
		Over-current locking times	5 times	
		Instant locking disabling	Connecting charger	

Function Name	Function Setting	Function Setting	Setting Value	Setting Range	
Output short-circuit protection	On (off setting not supported)	Short-circuit protection current and delay	Programming (not adjustable)		
		Short-circuit protection recovery	Charging recovers immediately or recovers automatically in 60s		
	On	Short-circuit protection locking	Repeated output short-circuit and exceeding Over-current locking times		
		Short-circuit locking times	5 times		
		Short-circuit locking disabling	Connecting charger		
Effective discharging current	Minimum charging starting current		-1000mA		
	Maximum discharging exiting current		-700mA		
Cell balancing function	On	Standby balancing	Turning on balancing when there is no charging/discharging		
		Standby balancing time	10 hours	Adjustable	
	On	Charging balancing	Switching on balancing when it is in charging or floating charging		
	Switching on voltage condition	Balancing turn-on voltage	3350mV	Adjustable	
		Balancing turn-on voltage difference	30mV		
		Balancing turn-off voltage difference	20mV		
	On	Balancing temperature limiting	Balancing turn-off temperature range based on temperature of ambient temperature alert		
		Balancing high temperature prohibiting	50°C	Adjustable	
Balancing low temperature prohibiting		0°C			

Function Name	Function Setting	Function Setting	Setting Value	Setting Range
Cell failure alert	On	Cell failure voltage difference	500mV	Adjustable
		Cell recovery voltage difference	300mV	
Battery capacity setting	Battery nominal capacity		111Ah	5Ah ~ 200Ah
	Battery residual capacity		Estimation from cell voltage	Adjustable
	Cycling accumulation capacity		80%	Cycling times (Adjustable)
	On	Residual capacity alert	15%	
	On	Residual capacity protection	5%	Turn off output
Reset button	Turn-on/activation		When BMS is in sleeping mod, press reset button for 1s. When BMS is activated and LED signal lights turn on, it's in normal working state.	
	Turn-off/sleeping		When BMS is in standby or working mode (except for charging), press reset button for 3s. BMS is in sleeping mode and LED signal lights turns on, it's in sleeping mode.	
Pre-charging function	2000ms	0~5000ms Adjustable	Activating Pre-charging function as soon as BMS turns on	
BMS power consumption management	On	Longest standby time	48h (when charger is absent and there is no effective discharging current)	
Cell low temperature heating	Off	Cell low temperature heating	0°C	Adjustable
		Cell heating recovery	10°C	
exterior switch	Off	When BMS is standing by, exterior switch can be Off or On.		
LCD screen	On	Simplify monitoring software and data of cell, temperature, current and so on can be checked		

Function Name	Function Setting	Function Setting	Setting Value	Setting Range
Manual charging activation	On	1 minute	BMS is switched off when it is under pressure protection. Compulsory output by manually activating deleting under pressure protection	Adjustable
Compensation resistance	Connection failure resistance	10mΩ	Between 8 and 9 by default	Battery connection wire resistance compensation
	Compensation point 1	0mΩ	9	Adjustable
	Compensation point 2	0mΩ	13	

4. Communication

4.1 CAN

BMS has the function of battery pack upload CAN communication, with the baud rate of 500K. CAN communication port adopts 8P8C network cable port. It can communicate with inverter or CAN TEST through CAN port. When the battery pack is connected, the RS485 communication is used to connect, and the battery pack data, status and information are uploaded to the PCS through CAN communication.

CAN communication port definition :

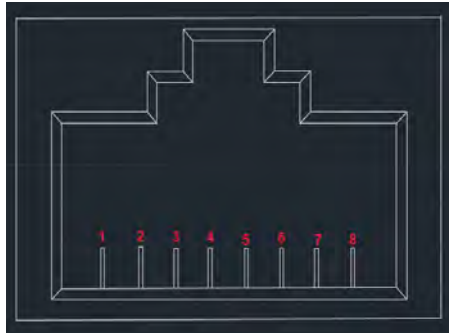

Quote	Definition Interpretation
1,2,7,8	NC
4	CAN-L
5	CAN-H
3,6	Ground

4.2 RS485

BMS has RS485 communication with battery pack set, with the baud rate of 19200bps. The RS485 communication interface adopts 8P8C network cable interface.

RS485 communication port definition:

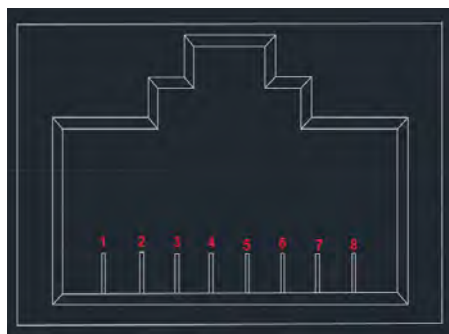

Quote	Definition Interpretation
1,8	RS485-B
2,7	RS485-A
3,6	Ground
4,5	NC (hung in the air)

4.3 Parallel Communication

When multiple machines are connected in parallel, the RS485 port is used as the parallel communication port, and the CAN port is used as the uplink communication port. The terminal device can read the sum of all parallel PACK battery data through the CAN port. When multiple parallel PACK battery data through the CAN port. When multiple machines are connected in parallel, the connection of the RS485 interface is shown in the following figure:

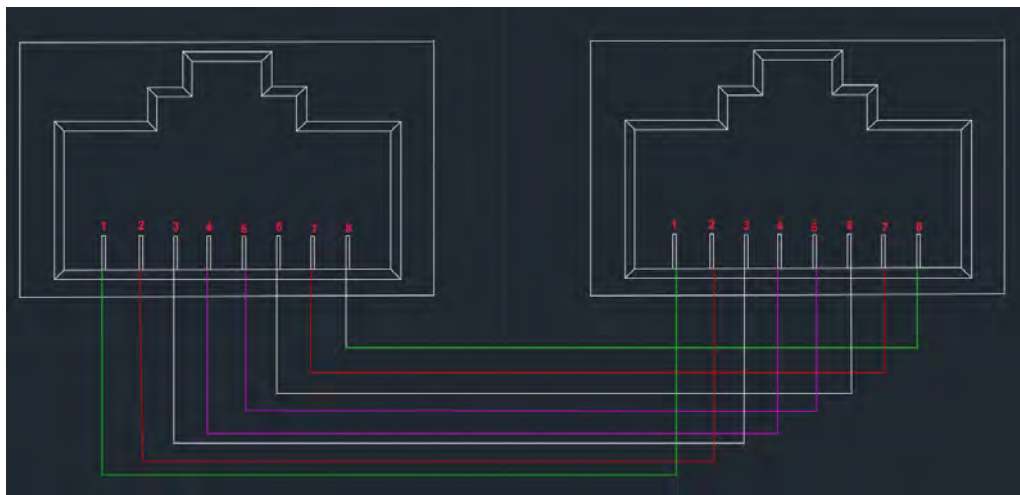

4.4 DIP Address

Parallel DIP Switch Definition: In the multi-computer communication when the battery packs are connected in parallel, the DIP switch is used to distinguish different Pack addresses, and the hardware address can be set through the DIP switch on the board.

DIP switch bit1 to bit8 definition: Bit1 to bit4 are used to set the address, and bit5 to bit8 are used for the number of slaves.

Master Device Setting: Bit1 to bit4 are 0, the master address is fixed to 0, and bit5 to bit8 are set according to the number of parallel slaves. (as in Table 2)

Slave Device Setting: Bit1 to bit4 are set according to the device order, and the slave address range is 1 to 15. Bit5 to bit8 are fixed to 0. (as in Table 1)

Parallel use address setting: refer to the following table for the definition of the DIP switch

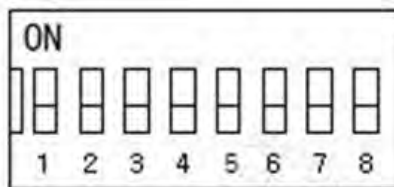

5. Working Mode

5.1 Charging Mode

When the BMS detects that the charger is connected and the external charging voltage is greater than the internal battery voltage by more than 0.5V, MOSFET charging will be on. When the charging current reaches the effective charging current, it enters the charging mode. When in charging mode, MOSFET charging and discharging are closed.

5.2 Discharging Mode

When BMS detects that there is load connection and the charging current reaches effective discharging current, it gets into discharging mode.

5.3 Standby Mode

When it is neither of the modes above, it gets into standby mode.

5.4 Power Off Mode

BMS gets into turn-off mode when standing by for 48 hours, battery under pressure protection is triggered, turning off by button or exterior switch.

Turning off mode activation conditions:

1. charging activation;
2. activation with 48V voltage;
3. manual turn-on

6. Indicators

6.1 LED Indicator Introduction

1 operation light, 1 alert light, 4 capacity signal lights

●	●	●	●	●	●
SOC				ALARM	RUN

6.2 Capacity Light

State		Charging				Discharging			
Capacity Signal Light		L4●	L3●	L2●	L1●	L4●	L3●	L2●	L1●
capacity	0 ~ 25%	Off	Off	Off	Blinking	Off	Off	Off	On
	25 ~ 50%	Off	Off	Blinking	On	Off	Off	On	On
	50 ~ 75%	Off	Blinking	On	On	Off	On	On	On
	≥75%	Blinking	On	On	On	On	On	On	On
Running Signal Light●		On				Blinking			

6.3 Blinking Information⁴



Blinking Way	On	Off
1 Blink	0.25s	3.75s
2 Blinks	0.5s	0.5s
3 Blinks	0.5s	1.5s

6.4 Indicator Status

System Condition	Operation State	RUN	ALM	SOC				Interpretation
		●	●	●	●	●	●	
Turn-off	Sleeping	Off	Off	Off	Off	Off	Off	All being off
Standby	Normal	Blinking	Off	Off	Off	Off	Off	Standby state
Charging	Normal	On	Off	Referring to Capacity Signal				Top LED blinks twice
	Over Current Alert	On	2 Blinks	Referring to Capacity Signal				Top LED blinks twice
	Over Pressure Protection	1 Blink	Off	Off	Off	Off	Off	
	Temperature and over current protection	1 Blink	Off	Off	Off	Off	Off	
Discharging	Normal	3 Blinks	Off	Referring to Capacity Signal				Referring to power turn-on signal
	Alert	3 Blinks	3 Blinks					
	Temperature, over current, short-circuit protection	Off	On	Off	Off	Off	Off	Stop discharging. Compulsory sleeping when there is no activity after it is offline for 48 hours
	Under pressure protection	Off	Off	Off	Off	Off	Off	Stop discharging

7. Installation

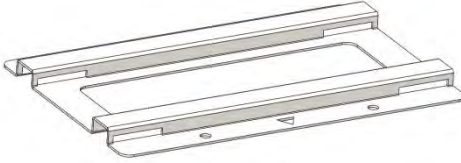
7.1 Cargo List

NO.	Name	Quantity	Picture
1.	Battery Pack	1 PCS	
2.	Wall-mount Bracket	1pcs	
3.	Anchor	4pcs	

7.2 Installation Environment

7.2.1 Check Battery Status



7.2.2 Installation Positioning

- Do not assemble the battery in combustible architecture material.
- Assemble the battery to solid wall and level it with eyes level so the LCD display screen can be read any time.
- Keep the temperature between 10°C and 30°C to maintain the best operation state. A vertical installation against the wall is recommended.
- There should be space for dissipation around the battery (as shown below). This applies to concrete surface or other incombustible surface.
- Mark the four fixed positions of the sockets. Anchors should be

upward with an angle of 10° to prevent falling down.

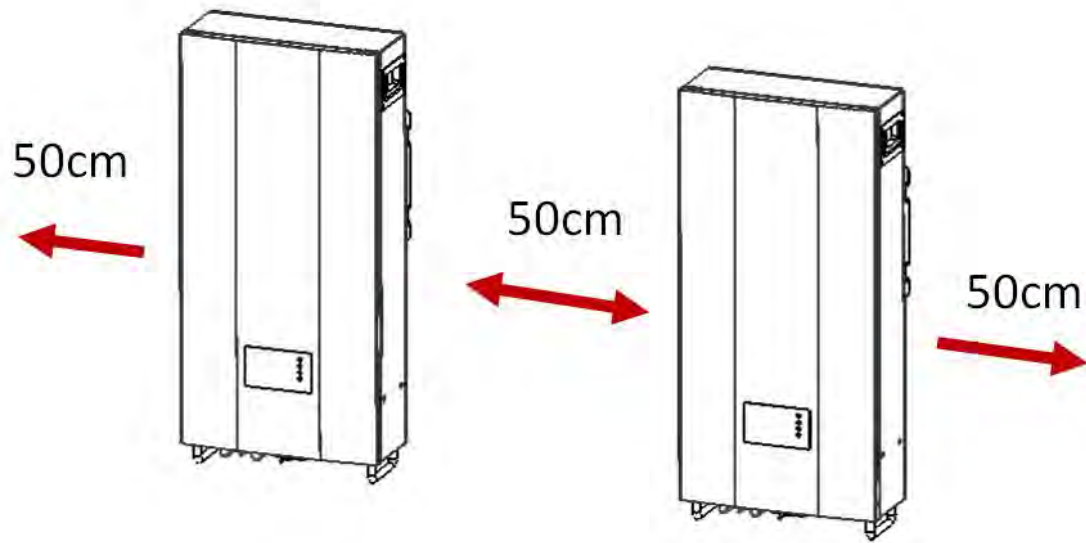

7.2.3 Wiring

Battery should be turned off before connection

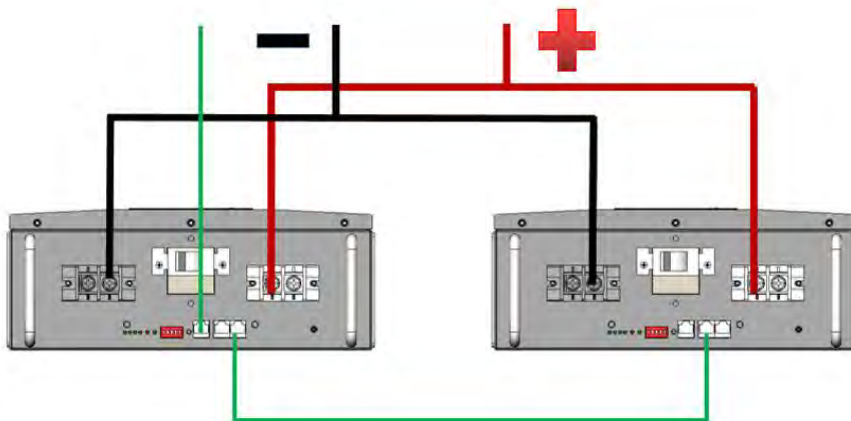

7.2.4 DIP Address Settings

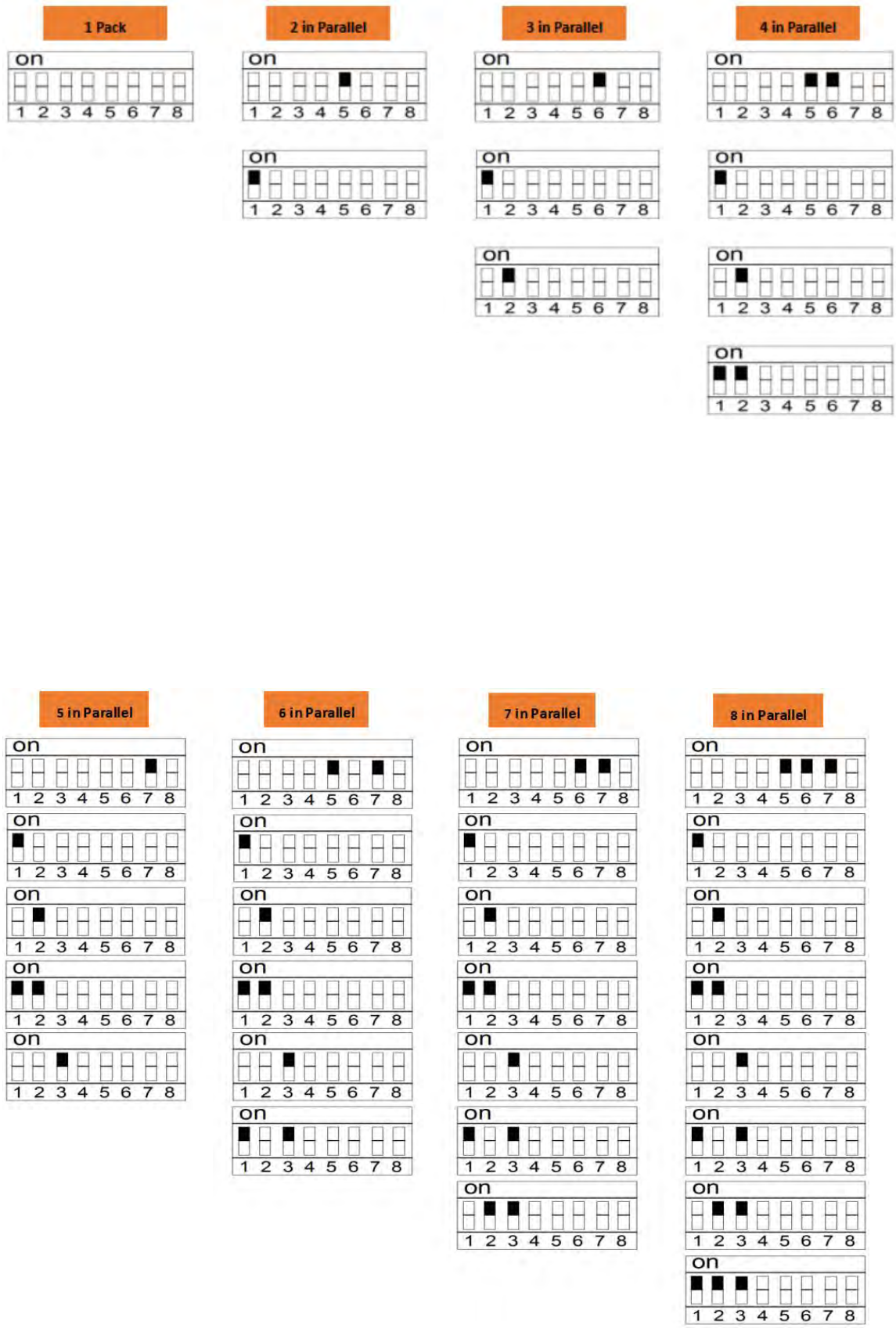

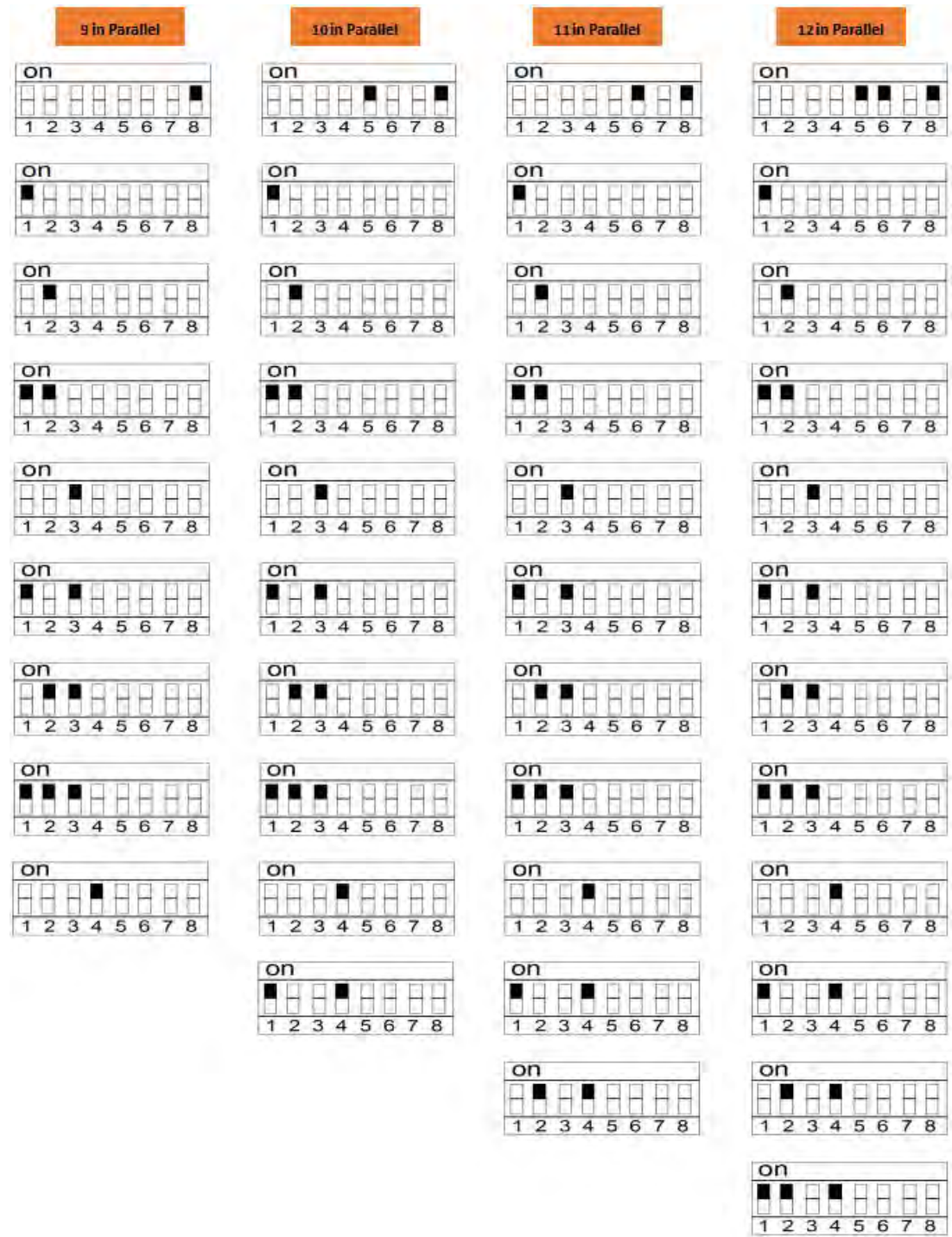

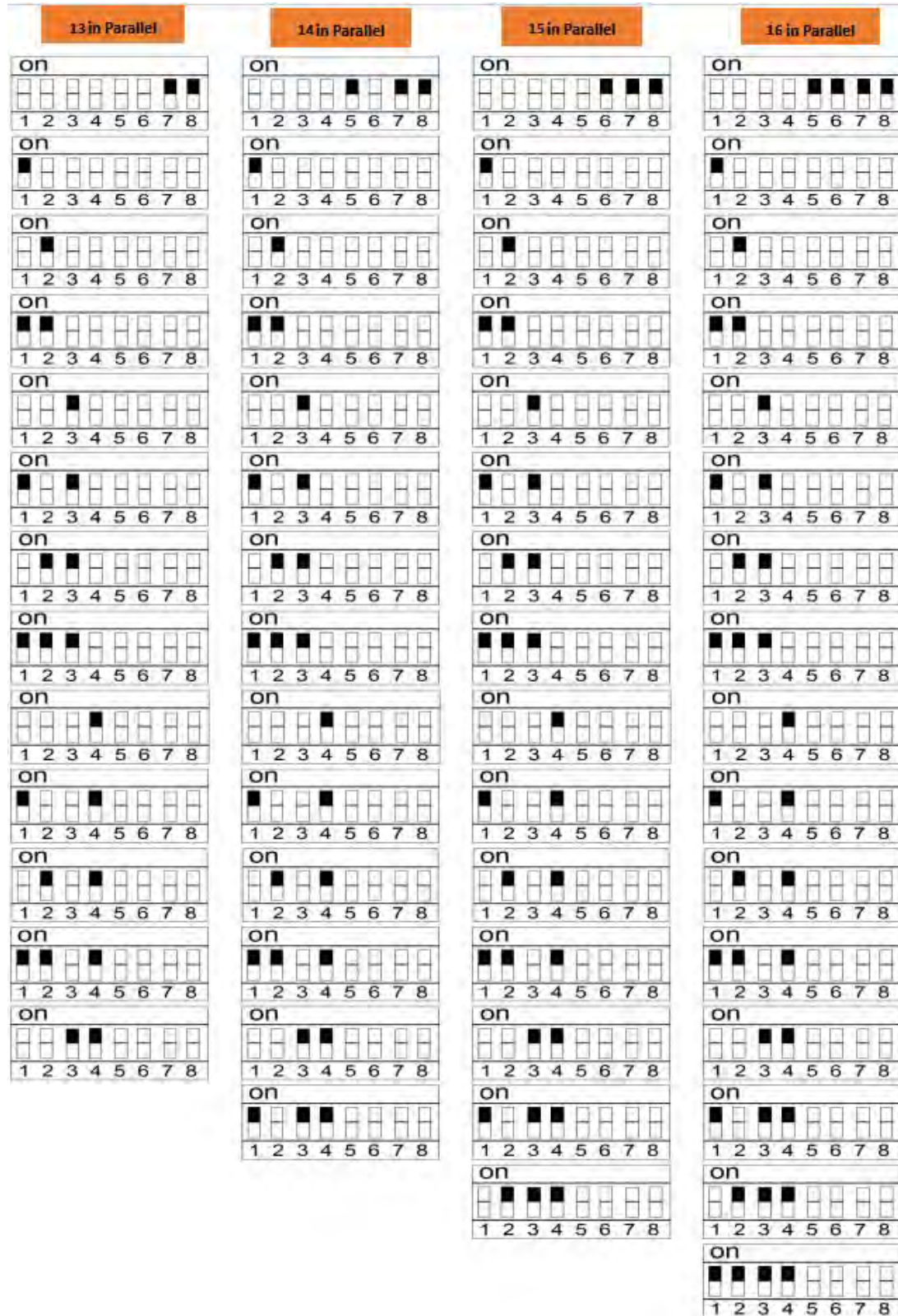

8. Packing

Pack it in a dry, dust-proof and moisture-proof box. Pack the product with plastic film/EPE and pack it in a wooden box.

Specification: L 1.2m*W 1.0m*H 1.1m 12 Packs Weight: 650kg

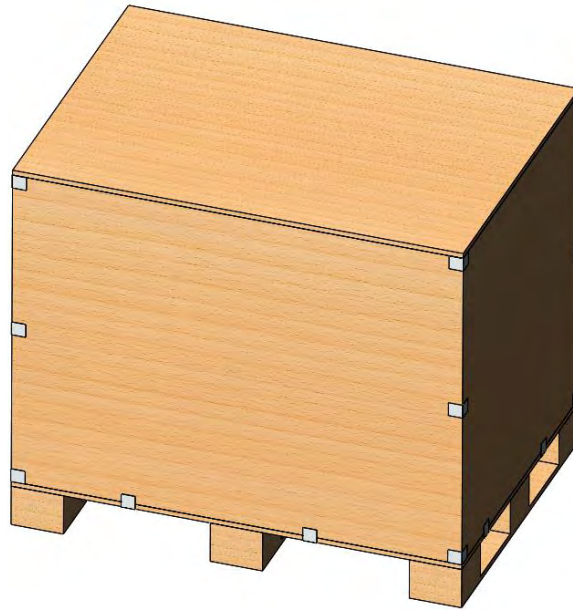

Specification: L 670cm*W 48cm*H 35cm 1 pack Weight: 60kg

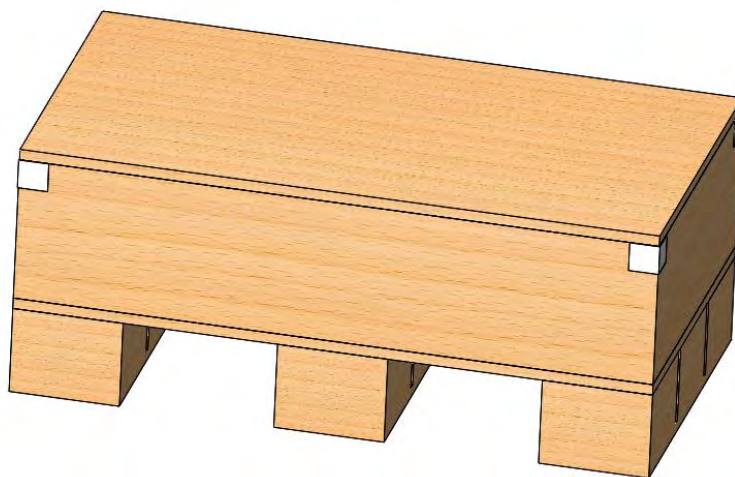

9. Safety precaution

- Do not use the battery if there is any obvious impact or deformation.
- Do not stack multiple batteries.
- Pay attention to the polarity of power source or the connection ends
- Use tools and apparatus properly and insulate the device properly.
- Battery installation sites should be away from fire sources or combustible objects.
- It is strictly prohibited to plug or unplug any kits from the device when it is running.
- It is prohibited for non-technicians to open any function modules. Anyone violating this rule is at his/her own risk.
- Please fully charge the battery with specialized charger before using the new battery or using it for a long duration.
- Do not assemble, open, squeeze, bend, deform, pierce or break the product.
- Do not retrofit the battery or plug it to any other exterior objects. Do not soak the product or expose it to liquids like water, fresh or salty, or beverage (coffee, juice and so on).
- Do not short-circuit the battery or contact the battery contact ends with metal or other conductors.
- Do not drop the battery. If it happens (especially dropping to the hard ground), please contact the service center.
- If there is any electrolyte leakage, make sure the battery make no contact with skin or eyes. If they have contact, please wash the contact area with fresh water or seek help from the doctors.
- Do not disassemble the cell battery in any circumstance. It may lead to internal short circuit or even cause fire or other problems.
- Do not burn the battery or put it in the fire in any circumstance. Otherwise, it may cause battery burning.



General Electronics Technology Co., Ltd.