

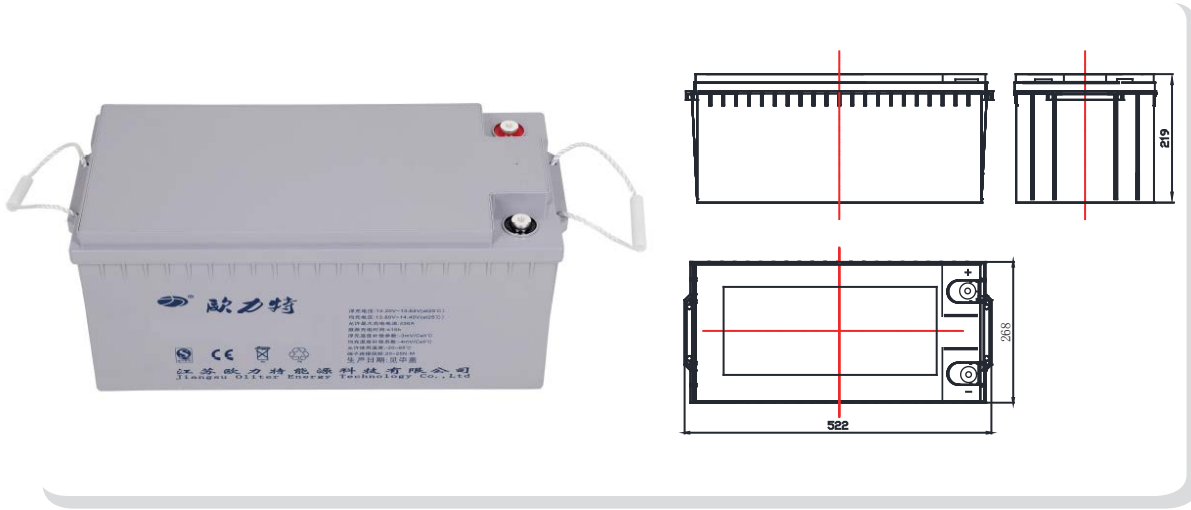

Jiangsu Oliter Energy Technology Co.,Ltd was founded in 1998,covered 42,000M2,annual throughput reaches 750000KVAH.Over the years ,Oliter is focusing on the integration of R&D,production,Marketing and application of VRLA,Gel battery,Lithium battery.By the support of South China Normal University,Xi'An JiaoTong University and Other scientific research institutes,Oliter has built up the post-doctoral workstations.Till now,Oliter has achieved 7 series,more than 100 models of batteries.Oliter has become the largest production base of solar energy storage battery in northern Jiangsu.

LCPC 200-12 GEL(PVC-SIO₂) BATTERY



Features

“Oliter” battery ,Maintenance free and easy to use, Contemporary advanced technology research and development of new high-performance batteries,It can be widely used in solar energy , wind energy , telecommunication systems , off-grid systems , UPS and other fields.The designed life for the battery could be twelve years up for float use.

Technology data

Rated Voltage	Capacity (10hr,1.80V/Cell)	Weight	Max Discharge Current	Max Charge Current	Self-Discharge (25℃)	Recommended Using Temperature	Cover Material	Separator
12V	200Ah	72Kg	30I10A (3min)	≤0.25C10	<3%/month	15℃~25℃	ABS	PVC
Using Temperature		Charge Voltage (25℃)	Temperature Compensation Coefficient(25℃)		Cycle life	Capacity Affected by Temperature		
Discharge: -45℃~50℃ Charge: -20℃~45℃ Storage: -30℃~40℃		Float Charge: 13.4V-13.7V Average Charge: 14.1-14.4V	Float Temperature Compensation Coefficient -3mV/Cell℃ Equalization Temperature Compensation Coefficient - 4mV/Cell℃		100%DOD 600times 50%DOD 1522 times 30%DOD 2328times	105 % @ 40℃ 85 % @ 0℃ 60 % @ -20℃		

Certificate

ISO9001
ISO14001
CE
CGC
TLC

High and New Technology Products Certification

Standards:
GB/T 19638.2-2005
YD/T799-2002
JISC8704-2:1999

Different discharge time at different terminal Voltage,discharge time(Amps,25)

Constant current discharge coefficient (25℃, A)									
Terminal Voltage (v/Cell)	1H	3H	5H	10H	20H	50H	100H	120H	240H
1.7	106.20	48.28	32.27	20.81	10.75	4.52	2.45	2.17	1.15
1.75	104.08	47.79	31.69	20.52	10.50	4.35	2.29	2.03	1.07
1.8	102.00	47.33	31.20	20.00	10.25	4.20	2.20	1.89	1.01
1.85	97.92	47.07	30.60	19.17	9.75	4.03	2.05	1.77	0.92
1.9	94.01	46.65	30.15	18.77	9.58	3.91	1.99	1.69	0.87
1.95	89.88	45.72	29.52	17.73	8.92	3.63	1.88	1.61	0.83





Performance characteristics

Temperature and Service life

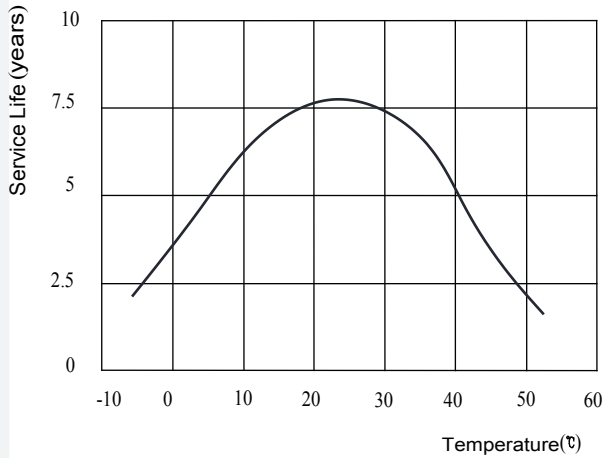

Discharge characteristics at Various Rates (25°C/77°F)

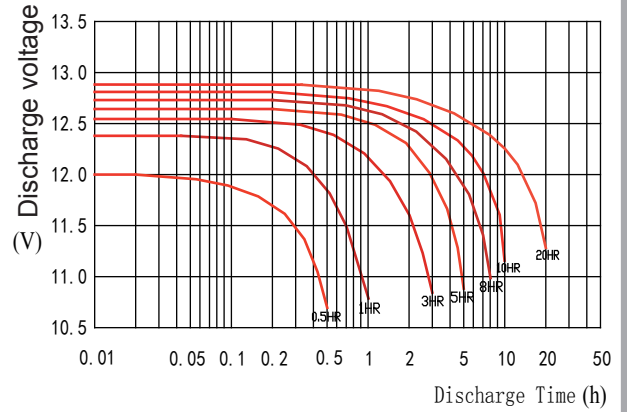

Temperature and discharge capacity

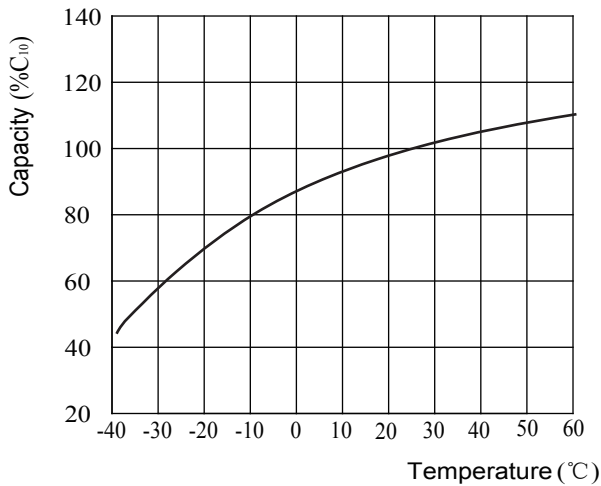

self discharge parameters characteristics

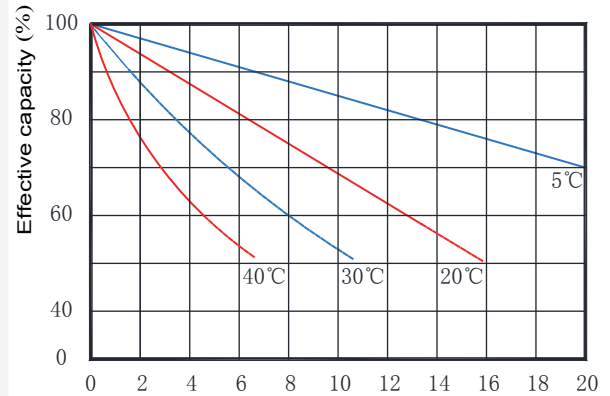

Constant-potential charge

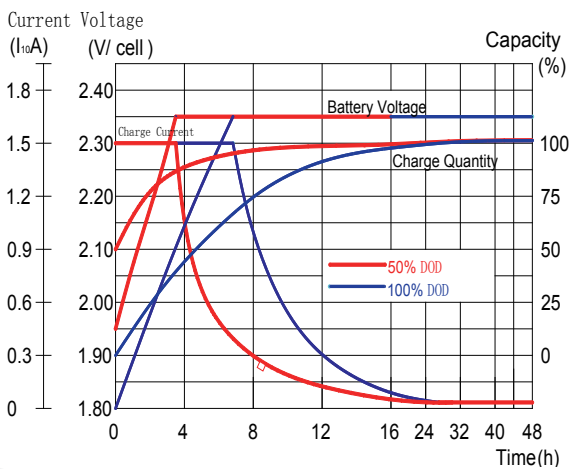

Cycle Service Life (25°C/77°F)

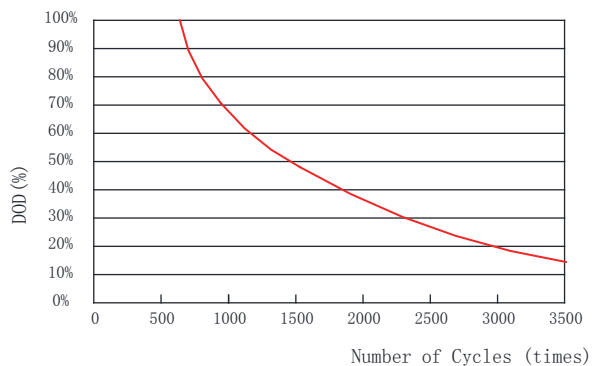

Note The above data are average values, and can be obtained within 3 charge/discharge cycles. These are not minimum values. Cell and battery designs/specifications are subject to modification without notice.

