

SEPLoS

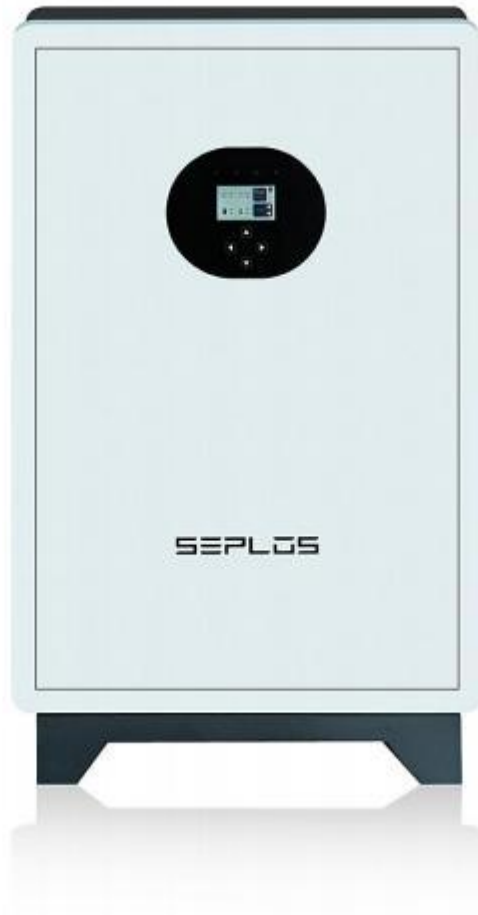

SEPLoS 51.2V 200Ah

Battery Pack User Manual

Dongguan Seplos Technology Co., Ltd

CONTENT

1. Introduction	3
2. Functions	3
3. Specifications	5
3.1 Appearance and dimension.....	5
3.2 Diagram	5
3.3 Performance and parameters	6
3.4 BMS settings	7
4. Communication	16
4.1 CAN communication	16
4.2 RS485 communication	16
4.3 Parallel communication	17
4.4 DIP address	18
5. Working mode	19
5.1 Charging mode	19
5.2 Discharging mode	19
5.3 Standby mode	19
5.4 Power off mode	19
6. LED indicator.....	19
6.1 LED lights	19
6.2 Capacity indicator.....	20
6.3 Lights blink	20
6.4 Status indicator.....	21
7. Installation	22
7.1 Packing list.....	22
7.2 Installation	23
7.2.1 Battery status.....	23
7.2.2 Installation position	23
7.2.3 Wiring	24
8. Packing	25
9. Safety precautions.....	26
Appendix - DIP Address Setup	27

1. Introduction

The 51.2V 200Ah Lithium ion battery pack, is applicable both for residential and commercial energy storage system, which is assembled with two PUSUNG-R Model that with 3.2V 100Ah LFP prismatic cell in 16S1P configuration, and accompany with 16S 100Ah SEPLOS Smart BMS. Each pack support 16 packs in parallel to easily expand capacity. The pack can not connected in series. And do not mix parallel the battery packs of different brands or models

2. Functions

- Calculation of battery voltage: Get the individual cell voltage of the 16cells. And the voltage difference around $\pm 20\text{mv}$.
- Detection of temperature: 4 temperature sensors for battery, 1 ambient sensor, 1 temperature sensor for MOSFET. The temperature value different around $\pm 2^{\circ}\text{C}$.
- Calculation of capacity and cycle times: calculate the real capacity via a complete charging and discharging cycle. The remaining capacity value difference around 5%.
- Equalization: Start balance at charging or standby status to prolong battery cycle life.
- Communication interface: The data can be monitored by command of remote regulation, telesignalization, telecontrol, and telemetering

through PC or other intelligent devices, correspond with YD/T 1363.3 protocol request and reach cascade communication at the same time.

- Read, store and record of historical data: easy check the historical data when battery get abnormal. Max. 500 status can be recorded and stored.
- Parameter setting: all the parameters, including low/over voltage threshold, charging/discharging current, high/low temperature, capacity, working mode, charging/discharging current limiting threshold ect. can be configurable via Battery Monitor software.
- Working mode: charging/discharging current limiting mode, rated voltage output mode, and directly output mode, three working mode to be selected via software.
- Multi-protection functions: battery protection, high/low temperature protection, short circuit protection, BMS protection.

3. Specifications

3.1 Appearance and dimension

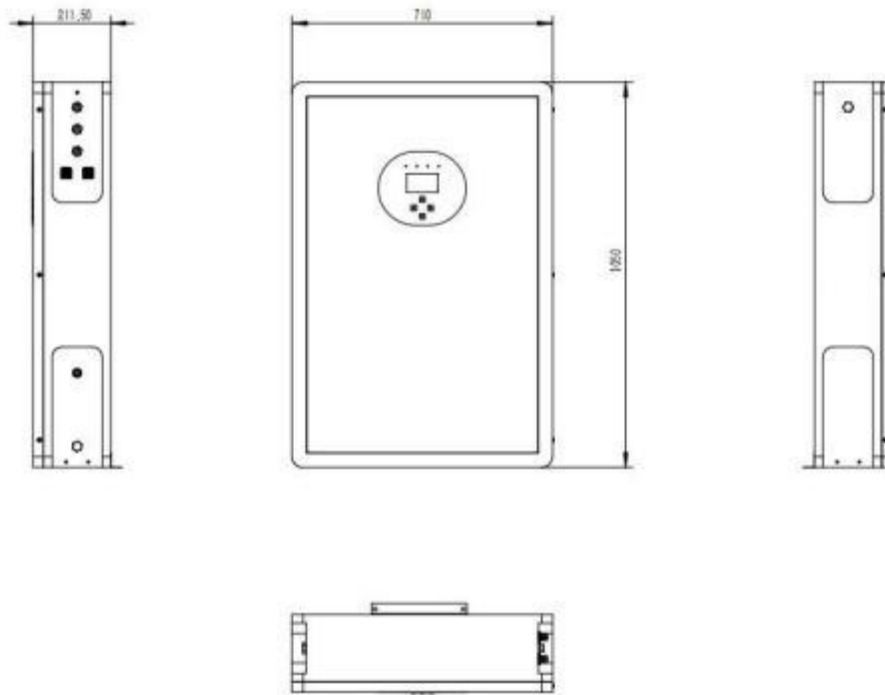

3.2 Diagram

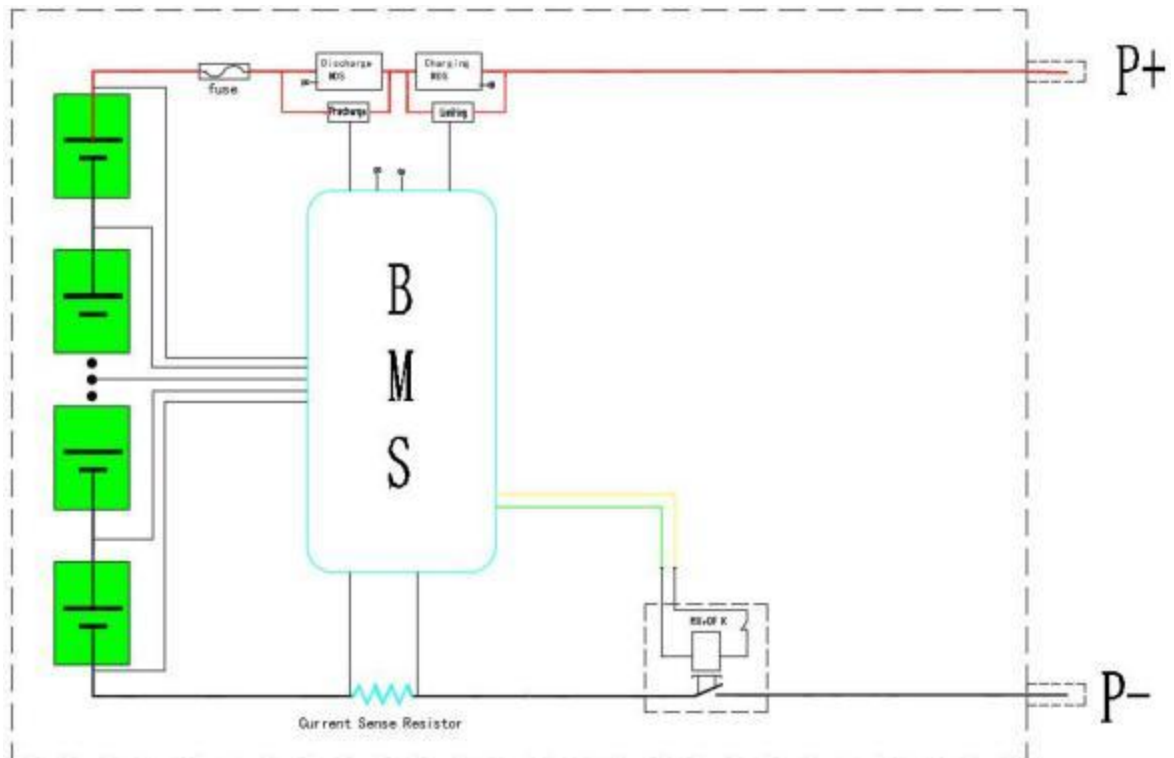

3.3 Performance and parameters

Items	Specifications
configuration	2*1P16S
Rated voltage	51.2V
Working voltage range	42V~58.4V
Rated capacity	200Ah
Rated energy	10.24KWh
Standard charging/ discharging current	100A @25± 2°C
Max. Charging current	200A@25± 2°C
Max. Discharging current	200A @25± 2°C
Working temperature range	0 ~ 40°C(Charge)
	-20 ~ 40°C(Discharge)
Storage temperature and humidity	- 10°C~35°C (For one month)
	25±2°C (For three months)
	65%±20%RH
Dimension	(1050)× (710)× (211.5)mm
Net weight	125Kg± 3kg
Cycle life	6000 cycles @25°C 50A charging/discharging current 80% DOD EOL80%
IP grade	IP 65
Communication interface	CAN&RS485
Altitude	0-3000m
Humidity range	5~95%

3.4 BMS settings

Functions	Status		Default	Configurable Range
Individual cell voltage warning	ON	Over voltage warning	3500mV	Over voltage warning recovery - over voltage protection
		Over voltage warning recovery	3400mV	3000mV - over voltage warning
		Under voltage warning	2900mV	Under voltage protection - under voltage warning recovery
		Under voltage warning recovery	3000mV	Under voltage warning - 3300mV
Individual cell over voltage protection	ON	Over voltage protection	3650mV	Over voltage warning - 4500mV
		Over voltage protection recovery	3400mV	Over voltage warning recovery - over voltage protection
		Over voltage recovery condition	1. Individual cell voltage decrease to over voltage recovery threshold. 2. The remaining capacity lower than 96% of the intermittent power supply. Both conditions should be satisfied. Output current $\geq 1A$	
Individual cell under voltage protection	ON	Under voltage protection	2700mV	1500mV - under voltage protection recovery
		Under voltage protection recovery	2900mV	Under voltage protection - under voltage warning
		Under voltage protection condition	When an individual cell gets under voltage protection threshold, BMS maintain communication with inveter for 1 minutes and powered off.	

		Under voltage protection recovery	Input current \geq 1A	
Total voltage warning	ON	Over voltage warning	56.0V	Over voltage warning recovery - over voltage protection
		Over voltage warning recovery	54.0V	53.0V - over voltage warning
	ON	Under voltage warning	46.4V	Under voltage protection - under voltage warning recovery
		Under voltage warning recovery	48.0V	Under voltage warning - 55.0V
Over voltage protection (total voltage)	ON	Over voltage protection	57.6V	Over voltage warning - 60.0V
		Over voltage protection recovery	54.0V	Over voltage warning recovery - over voltage protection
		Over voltage protection recovery conditions	1. Individual cell voltage decrease to over voltage recovery threshold. 2. The remaining capacity is lower than 96% of the intermittent power supply. Both conditions should be satisfied.	
			Output current \geq 1A	
Under voltage protection (total voltage)	ON	Under voltage protection	41.6V	36.0V - under voltage warning recovery
		Under voltage protection recovery	46V	Under voltage protection - under voltage warning
		Under voltage protection condition	When the total voltage gets under voltage protection threshold, BMS maintain communication with inverter for 1 minutes and powered off.	

		Under voltage protection recovery conditions	Input current≥1A	
Cell temperature (Charging)	ON	High temperature warning (charging)	50°C	High temperature warning recovery - high temperature protection
		High temperature warning recovery (charging)	47°C	35°C - high temperature warning
		High temperature protection (charging)	55°C	High temperature protection recovery - 80°C
		High temperature protection recovery (charging)	50°C	High temperature warning recovery - high temperature protection
		Low temperature warning (charging)	2°C	Low temperature protection - low temperature warning recovery
		Low temperature warning recovery (charging)	5°C	Low temperature warning - 10°C
		Low temperature protection (charging)	-10°C	-20°C - low temperature protection recovery
		Low temperature protection recovery (charging)	0°C	Low temperature protection - low temperature warning recovery
Cell temperature (Discharging)	ON	High temperature warning (discharge)	52°C	High temperature warning recovery - high temperature protection
		High temperature warning recovery (discharge)	47°C	High temperature protection recovery - 80°C
		High temperature protection (discharge)	55°C	High temperature warning recovery - high temperature protection

		High temperature protection recovery (discharge)	50°C	High temperature warning recovery - high temperature protection
		Low temperature warning (discharge)	-10°C	Low temperature protection - low temperature warning recovery
		Low temperature warning recovery (discharge)	3°C	Low temperature warning - 10°C
		Low temperature protection (discharge)	-15°C	-30°C - low temperature protection recovery
		Low temperature protection recovery (discharge)	0°C	Low temperature protection - low temperature warning recovery
Ambient temperature	ON	High temperature warning	50°C	High temperature warning recovery - high temperature protection
		High temperature warning recovery	47°C	-20°C - high temperature warning recovery
		High temperature protection	60°C	High temperature protection recovery - 80°C
		High temperature protection recovery	55°C	High temperature warning recovery - high temperature protection
		Low temperature warning	0°C	Low temperature protection - low temperature warning recovery
		Low temperature warning recovery	3°C	Low temperature warning - 60°C
		Low temperature protection	-10°C	-30°C - low temperature protection recovery

		Low temperature protection recovery	0°C	Low temperature protection - low temperature warning recovery
PCB temperature	ON	High temperature warning	90°C	High temperature warning recovery - high temperature protection
		High temperature warning recovery	85°C	60°C - high temperature warning
		High temperature protection	100°C	High temperature warning - 120°C
		High temperature protection recovery	85°C	High temperature warning recovery - high temperature protection
Current limiting (charging)	OFF	Active current limiting	10A	When the charger current > 10A, current limiting activated.
	ON	Passive current limiting		When the charger current > charging over current warning (configurable), current limiting activated.
			Charging current limiting time delay	5 min

Over current warning (charging)	ON	Over current warning	200A	Charging over current warning recovery - charging over current protection
		Over current warning recovery	195A	0A - charging over current warning
Over current protection (charging)	ON	Over current protection	210A	0A~150A
		Over current protection time delay	10S	Configurable
		Over current protection recovery conditions	1. BMS detects any output discharge current. 2. After 60 seconds, the protection recovers automatically.	
Effective charging current	Charging current (in)		1000mA	
	Charging current (out)		700mA	
Over current warning (discharging)	ON	Over current warning	-205A	Over current protection - over current warning recovery
		Over current warning recovery	-203A	Over current warning - 0A
Over current protection (discharging)	ON	Over current protection	-210A	Transient over current protection - 0A
		Over current protection time delay	10S	Configurable
		Over current protection recovery conditions	1. BMS detects any input charge current. 2. After 60 seconds, the protection recovers automatically.	
Over current protection (Transient)	ON	Over current protection	-300A	Discharge over current protection - 300A

		Over current protection time delay	30mS	Configurable
		Over current protection recovery	1. BMS detects any input charge current. 2. After 60 seconds, the protection recovers automatically.	
	OFF	Over current lock	1. Continuously over current for 2 times. 2. The over current lock times exceeded.	
		Over current lock times	5 times	
		Over current lock release	Connected with charger	
Short circuit protection	ON (Cannot be turn off)	Short circuit protection current value and time delay	Programmed into the software (can not be edited)	
		Short circuit protection recovery	1. BMS detects any input charge current. 2. After 60 seconds, the protection recovers automatically.	
	ON	Short circuit protection lock	1. Continuously short in the output circuit. 2. The over current protection lock times exceeded.	
		Short circuit protection lock times	5 times	
		Short circuit protection lock release	Connected with charger	
Effective discharging current	Discharge current (in)		- 1000mA	
	Discharge current (out)		-700mA	
Cell equalization	ON	Standby equalization	When there is no charging and discharging current flow, the standby equalization will be activated.	
		Standby time	10 hours	configurable

	ON	Charging equalization	When at the charging or float charging status, the charging equalization will be activated.	
	Equalization activate condition	Activate voltage	3350mV	Configurable
		Activate voltage difference	30mV	
		End voltage	20mV	
	ON	Temperature	According to the temperature range of no equalization (ambient temperature)	
No equalization high temperature		50°C	Configurable	
No equalization low temperature		0°C		
Cell failure	ON	Voltage difference	500mV	Configurable
		Voltage difference recovery	300mV	
Capacity	Nominal capacity		200AH	5-200Ah
	Remaining capacity		Calculated accordingly to the cell voltage	Configurable
	Cycle life accumulated capacity		20%	Cycle life (configurable)
	ON	Remaining capacity warning	15%	
	ON	Remaining capacity protection	5%	Output current flow will be cut off.
Reset button	Power on/activate		When in the standby status, hold the reset button for 1 second. The BMS will be activated. The LED indicators will be lighten in order. Then the BMS enters running status.	

			When in standby or running status (except for charging), hold the reset button for 3 seconds, The BMS enters sleeping mode. The LED indicators will be lightened in order. Then the BMS enters sleeping status.	
Pre-charging	2000ms	0-3000ms	The pre-charging function will be activated once the BMS is powered on	
BMS power consumption	ON	Longest standby time	48 hours (Do not connect with charger, and no effective charging current)	
Heating	OFF	Start heating temperature	0°C	Configurable
		Stop heating temperature	10°C	
		Heating function activation	When connected with charger, and the cell temperature reaches the setting value, the heating function is activated. Heating function is disabled when at standby and discharge status.	
External switch	OFF	When at the standby status, the BMS can be powered on/off through external switches.		
LCD screen	ON	Monitoring software to check the cell voltage, temperature and current		
Charging activating	ON	The BMS is powered off after under voltage protection. Press the button to recover from protection status and activate output current	1 minutes	Configurable
Compensating impedance	Continuously fault impedance	10mΩ	Default value from 8 to 9	Battery connection wire compensating impedance
	Compensation 1	0mΩ	9	Configurable
	Compensation 2	0mΩ	13	

4. Communication

4.1 CAN communication

The battery pack supports CAN communication with inverters at the baud rate of 500K. The CAN communication interface applied 8C8P Ethernet port. The battery pack can transmit information with inverter or CAN TEST equipment through the CAN interface. The paralleled packs transmit information through RS485 interface, and then, the master pack gathering the system information, and transmit to inverter and PCS through CAN communication.

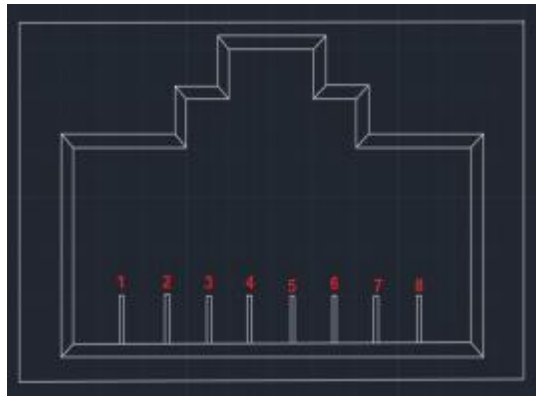

PIN	Definition
1/2/7/8	NC
4	CAN- L
5	CAN- H
3/6	GND

4.2 RS485 communication

The battery pack supports RS485 communication at the baud rate of 19200bps. The RS485 communication interface applied 8C8P Ethernet port.

The pin definition as follows:

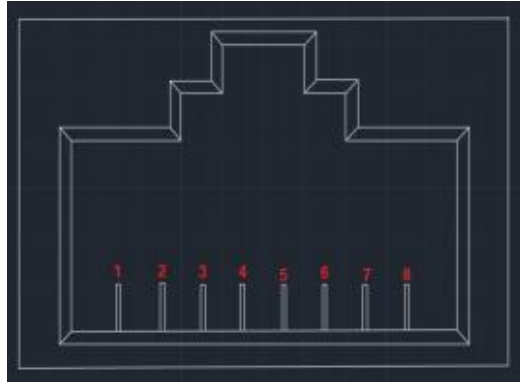

PIN	Definition
1/8	RS485- B
2/7	RS485-A
3/6	GND
4/5	NC

4.3 Parallel communication

When connected in parallel, the paralleled battery packs communicate with each other through RS485 interface. Then the master packs gathering the information of the whole system, and communicate with inverter and other devices through CAN interface.

The RS485 interface is as follows:

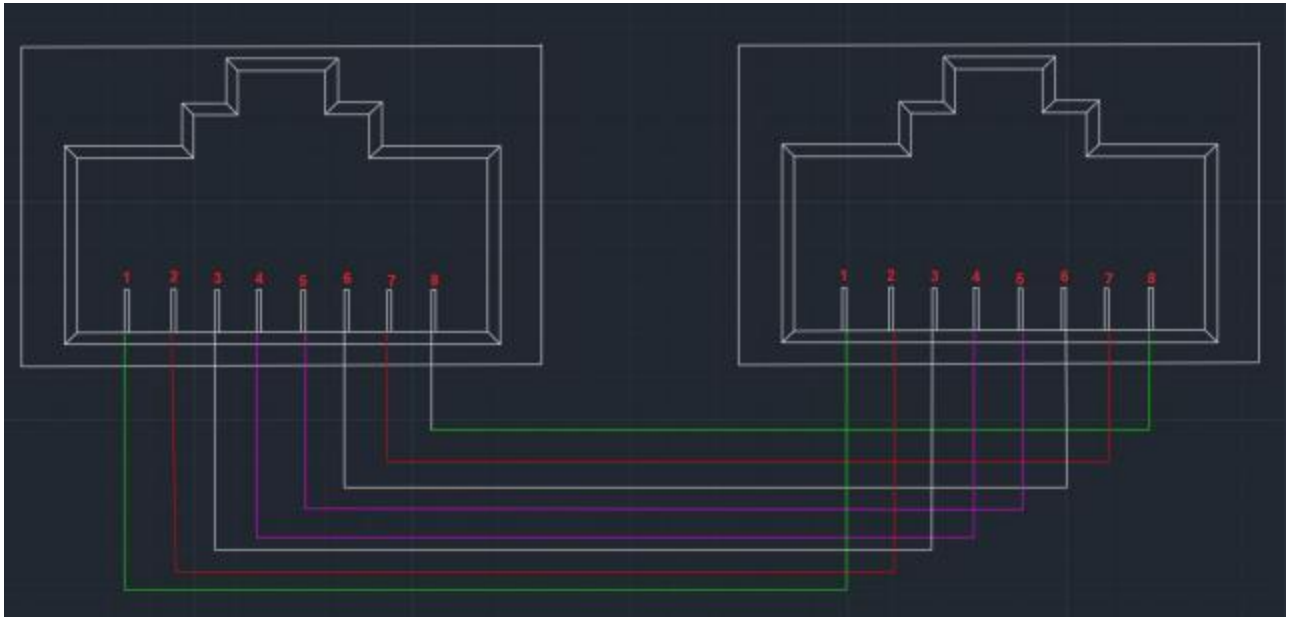

4.4 DIP address

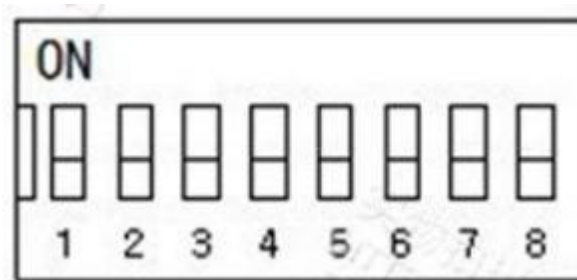

- DIP address: when connected in parallel, DIP switches are applied for identification.
- DIP switch introduction: #1, #2, #3, #4 indicate the pack identity, from which 4 switches with Max. Of 16 different identifications. #5, #6, #7, #8 indicate the quantity of slave packs.
- Master pack settings: #1, #2, #3, #4 set off. #5, #6, #7, #8 accordingly to the quantity of slave packs.
- Slave pack settings: #1, #2, #3, #4 accordingly to the binary settings. And #5, #6, #7, #8 set off. (Check the appendix)

5. Working mode

5.1 Charging mode

When a charger was detected, and the charger voltage is 0.5V+ more than the battery voltage, BMS will turn on the charging MOSFET. And when the charging current reaches the effective charging current value, BMS enters charging mode. At charging mode, charging and discharging MOSFET are both turned on.

5.2 Discharging mode

When a loads was detected, and the discharging current reaches the effective charging current value, BMS enters discharging mode.

5.3 Standby mode

When the BMS not in charging mode, nor discharging mode, it enters standby mode.

5.4 Power off mode

When the battery standby for 48 hours, and the battery is in under voltage protection status, or to press the reset/external switches, then the BMS will enter power off mode.

6. LED indicator

6.1 LED lights

One running indicator (Green)

one warning indicator (Red)

and four capacity indicator (Green)

●	●	●	●	●	●
SOC				ALARM	RUN

6.2 Capacity indicator

Status	Charging				Discharging			
Capacity	L4 ●	L3 ●	L2 ●	L1 ●	L4 ●	L3 ●	L2 ●	L1 ●
0-25%	OFF	OFF	OFF	Blink	OFF	OFF	OFF	Green
25%-50%	OFF	OFF	Blink	Green	OFF	OFF	Green	Green
50%-75%	OFF	Blink	Green	Green	OFF	Green	Green	Green
≥75%	Blink	Green	Green	Green	Green	Green	Green	Green
Running	Green				Blink			

6.3 Lights blink



Blink Type	Lighten TIEM	OFF TIME
Blink A	0.25S	3.75S
Blink B	0.5S	0.5S
Blink C	0.5S	1.5S

6.4 Status indicator

SYSTEM	RUNNING	RUN	ALM	SOC				REMARK
		•	•	•	•	•	•	
OFF	SLEEPING	OFF	OFF	OFF	OFF	OFF	OFF	OFF
STANDBY	RUNNING	Blink A	OFF	OFF	OFF	OFF	OFF	Standby
CHARGE	RUNNING	Green	OFF	According to the remaining capacity				LED Blink B
	Over current warning	Green	Blink B	According to the remaining capacity				LED Blink B
	Over voltage protection	Blink A	OFF	OFF	OFF	OFF	OFF	
	Temp. And over current protection	Blink A	Blink A	OFF	OFF	OFF	OFF	
DISCHARGE	RUNNING	Blink C	OFF	According to the remaining capacity				
	warning	Blink C	Blink C					
	Temp. Over current, short circuit protection	OFF	RED	OFF	OFF	OFF	OFF	
	Under voltage protection	OFF	OFF	OFF	OFF	OFF	OFF	No discharge

7. Installation

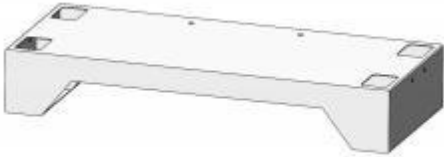
7.1 Packing list

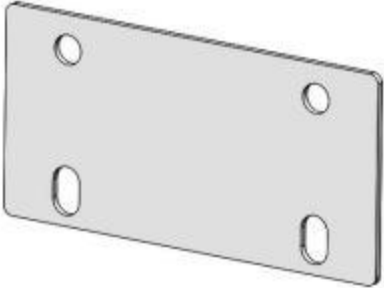
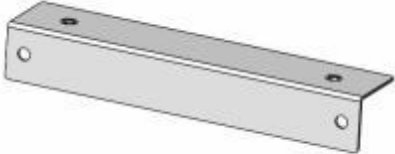
Items	QTY	Picture
51.2V 200Ah PANAMA Battery Pack	1 PCS	
PANAMA Stand	1PCS	
Wall Mount anchor	4PCS	
Wall Mount Bracket A	2PCS	
Wall Mount Bracket B	1PCS	
Wall Mount Bracket C	1PCS	

7.2 Installation

7.2.1 Battery status



7.2.2 Installation position

- Keep the battery pack away from flammable material wall.
- Adjust the height of the before formal installation to ensure the screen at the eyesight.
- Keep the ambient temperature between 10-30 °C to ensure the best permanence of battery pack.

- Leave some room for heat dissipation. For concrete wall, please refer to the following picture.
- Mark the screw hole position before drill holes on the wall. And keep the anchor 10 degrees upper in case the anchor fallen off.

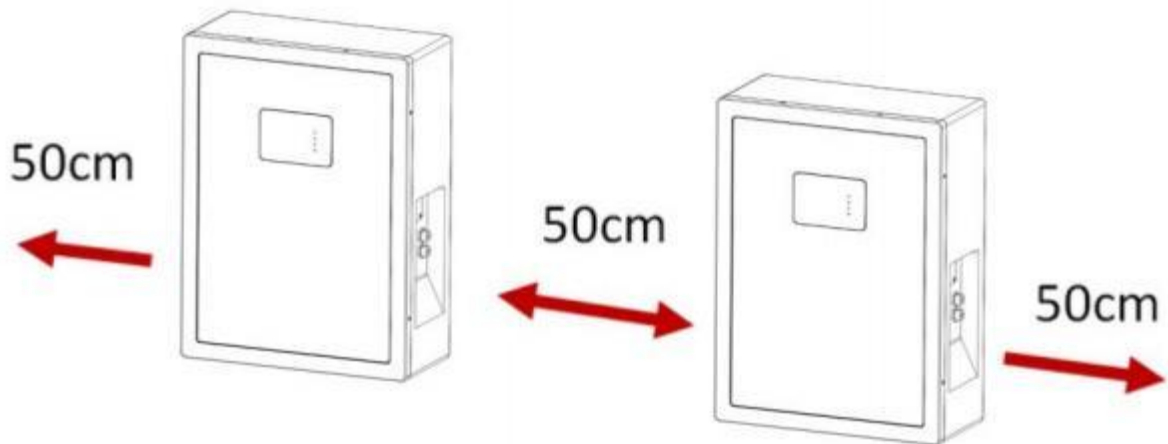

7.2.3 Wiring

Power off the battery pack before formal installation.

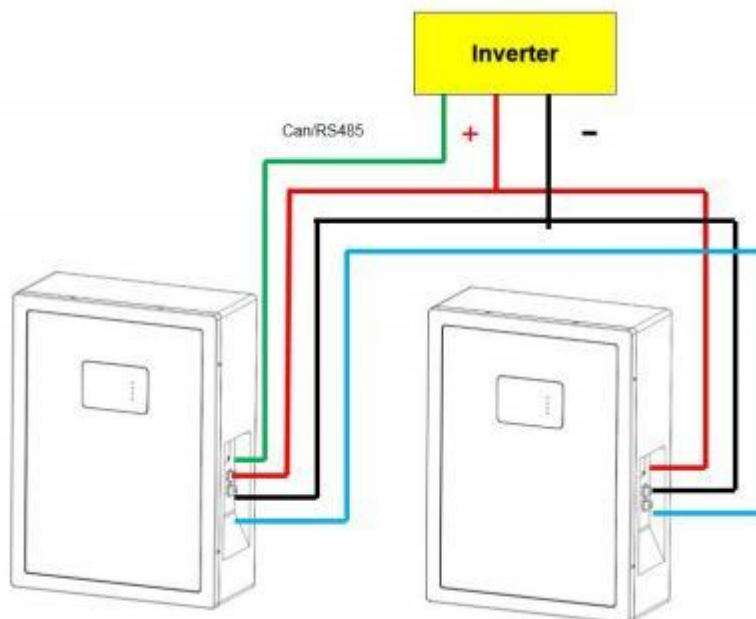

8. Packing

Small wooden box:

Dimension: L 115cm*W 81cm*H 400cm

Weight: 140KG

Capacity: 1 unit



Big wooden box:

Dimension: L 1.2m*W 0.9m*H 1.1m

Weight: 430Kg

Capacity: 3 unit



9. Safety precautions

- Do not use the pack if there' s any deformation.
- Do not stack up the battery.
- Do not reverse the P +, P- terminals of the battery pack.
- Do not let the tools and devices get direct contact with battery terminals.
- Keep the battery away from flammable obstacles. And keep the environment dry and ventilate.
- Do not open the battery pack. Or SEPLOS will not take any responsibility that may cause.
- Do not disconnect the battery terminals when its running.
- Please fully charge a new battery pack, or a long-time-no-use battery pack with a designed charger.
- Do not open, crush, bend or pierce the battery pack.
- Do not immerse the battery into any water, sea water, or drinks and other liquids.
- Do not short circuit the battery pack.
- Keep the battery pack away from explosive obstacles.
- Do not throw take apart the battery pack, or throw it to the fire, or there will be chances of a fire disaster.
- If there' s any signs of Electrolyte leakage, do not let it get any direct contact with your bare skin.

Appendix - DIP Address Setup

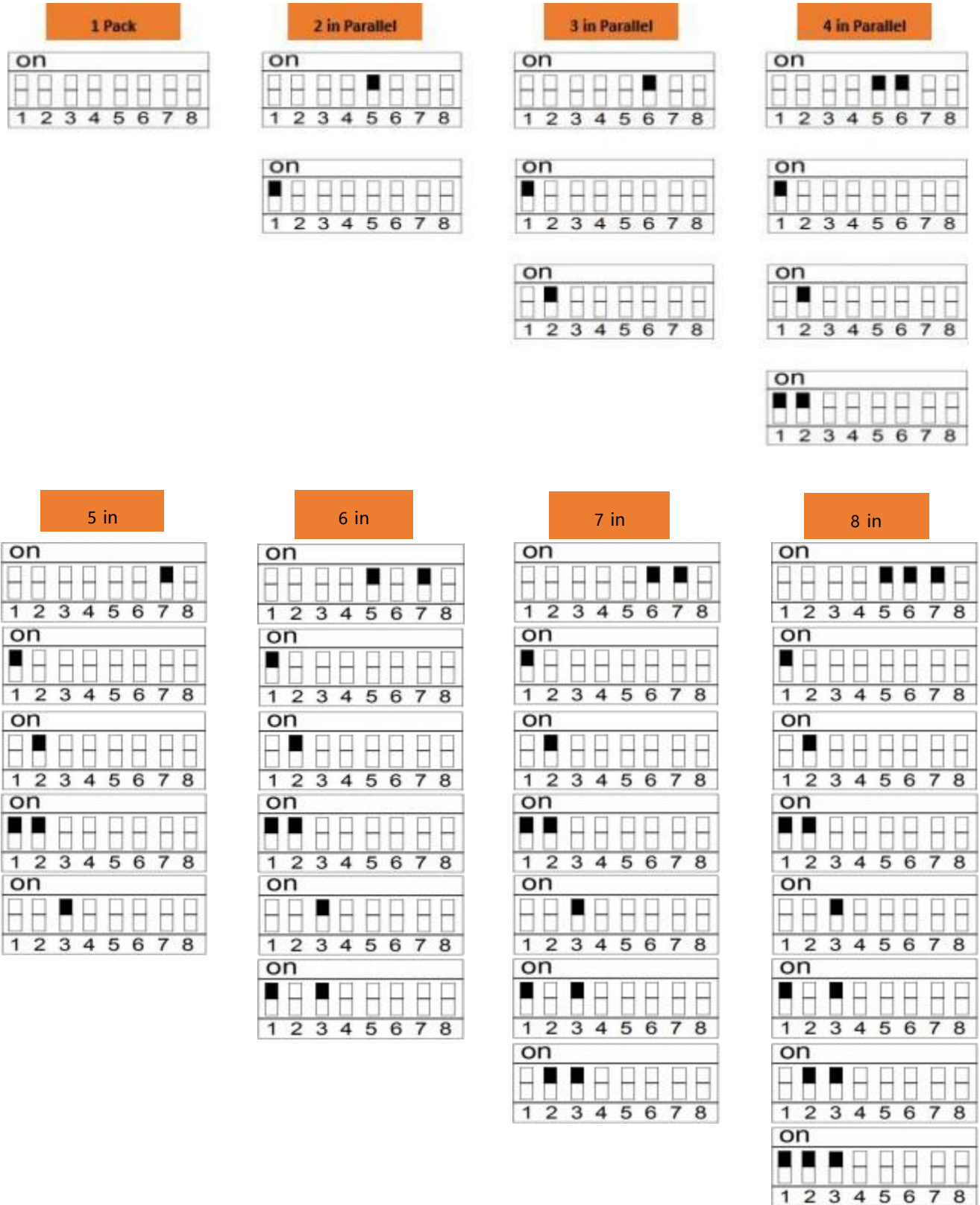

9 in Parallel

10 in

11 in

12 in

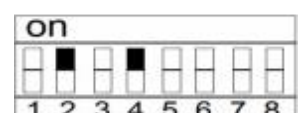
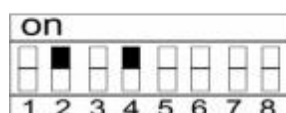
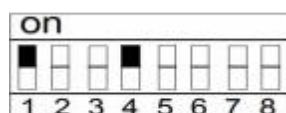
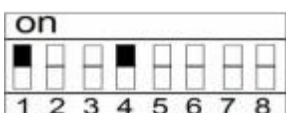
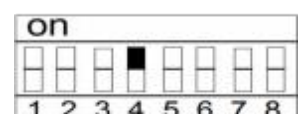
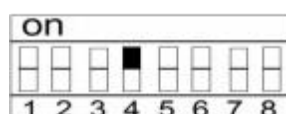
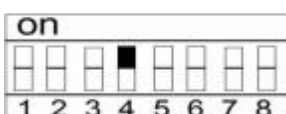
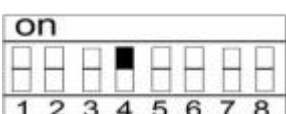
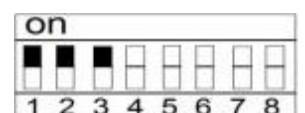
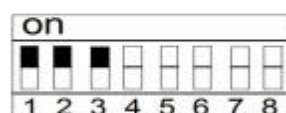
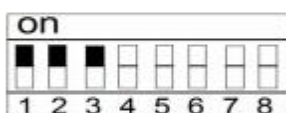
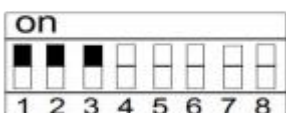
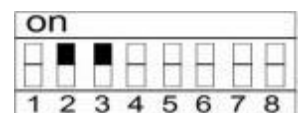
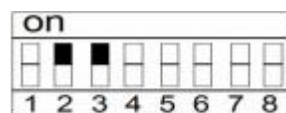
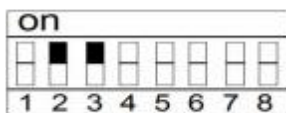
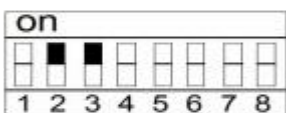
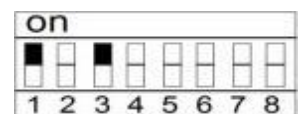
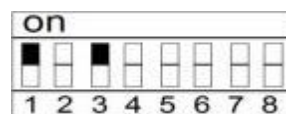
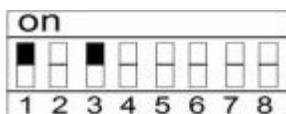
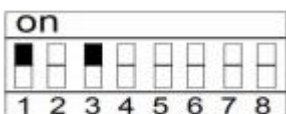
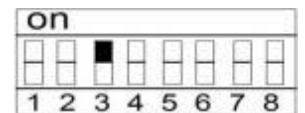
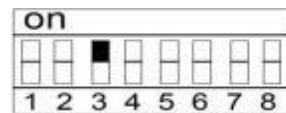
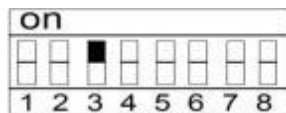
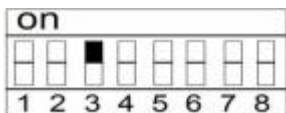
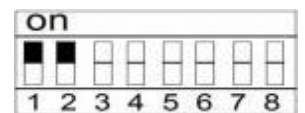
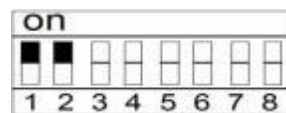
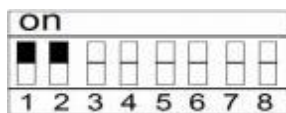
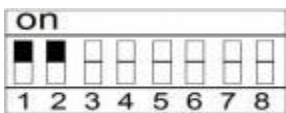
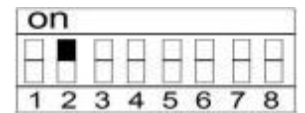
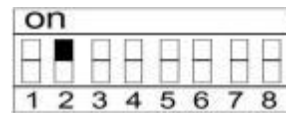
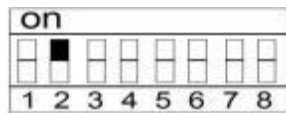
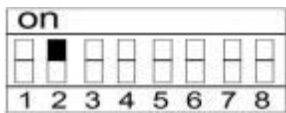
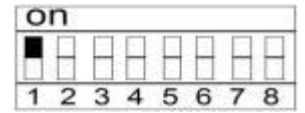
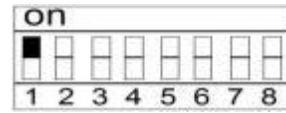
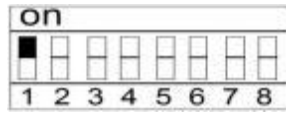
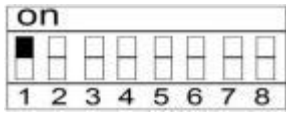
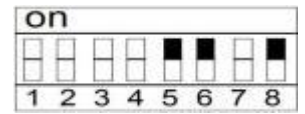
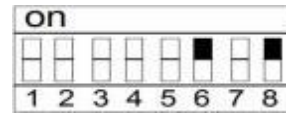
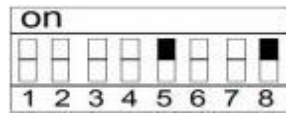
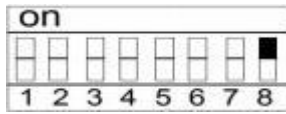

13 in Parallel

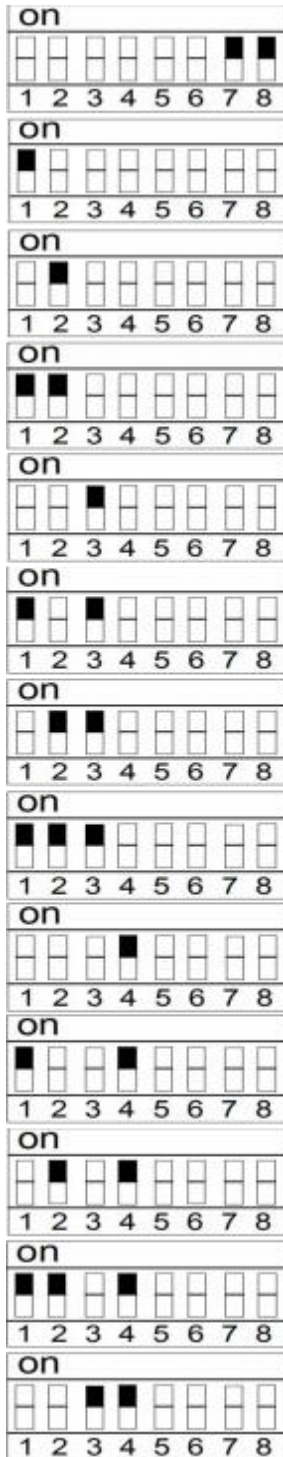

14 in Parallel

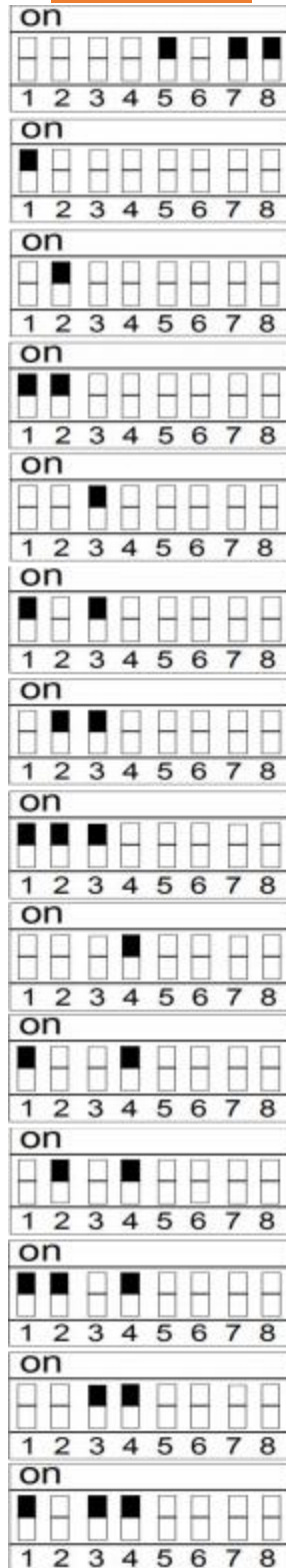

15 in Parallel

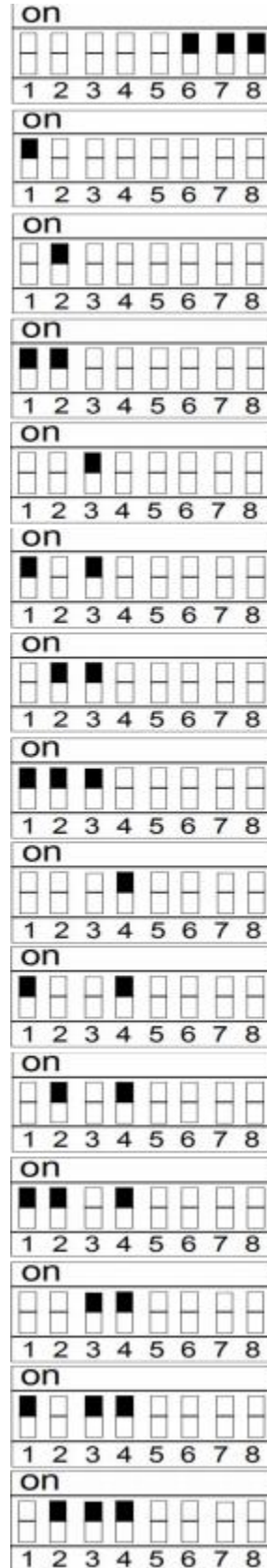

16 in Parallel

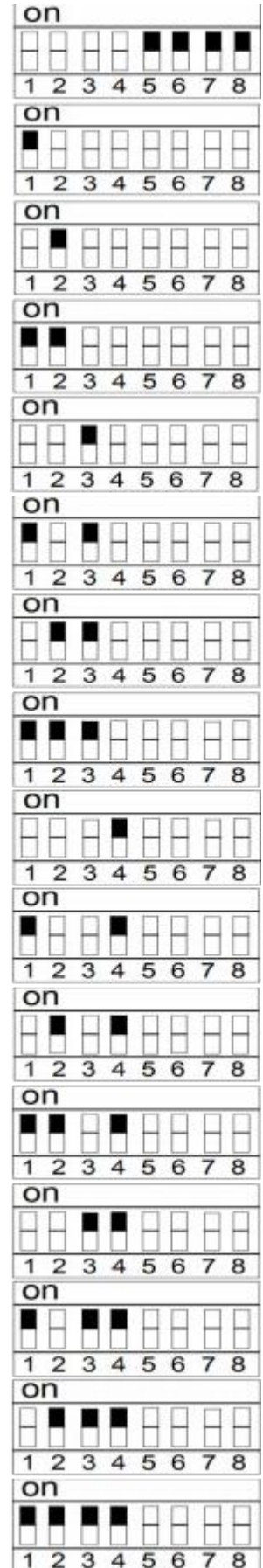



SEPLOS
Trust for Trust

This document is subject to change without notice.

©2022 SEPLOS Technology

Room 301, Building 6, Xinde Industrial Park, No. 179 Kangyi Road, Qingxi Town,
Dongguan China.

TEL: (86) 13286686628

E-mail: info@seplos.com

<http://www.seplos.com>