

# PV Micro inverter

## GT1600W

- Single unit connects up to two PV modules
- Maximum GT1600W AC output power
- Single phase output, Flexible 3-phase PV system
- WIFI communication and cloud monitoring
- Up to 10 units (230V) per branch
- Customizable various input (DC, PV) voltage range
- Integrated AC bus cable, Ready-To-Use
- Low cost, Easy installation

### Basic structure

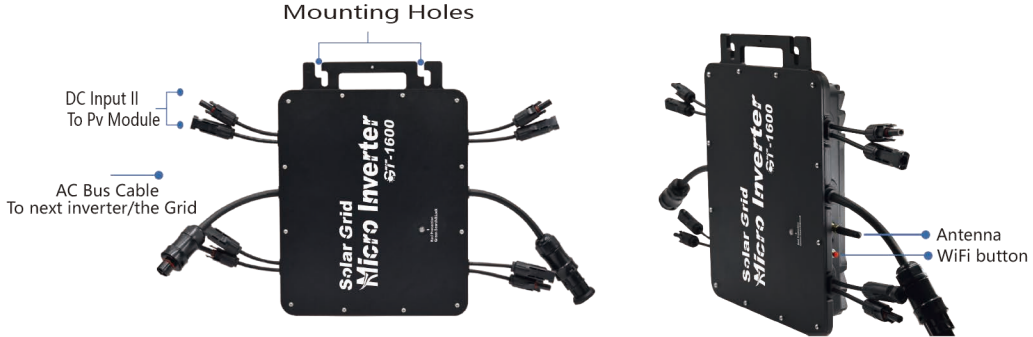

### Dimensions

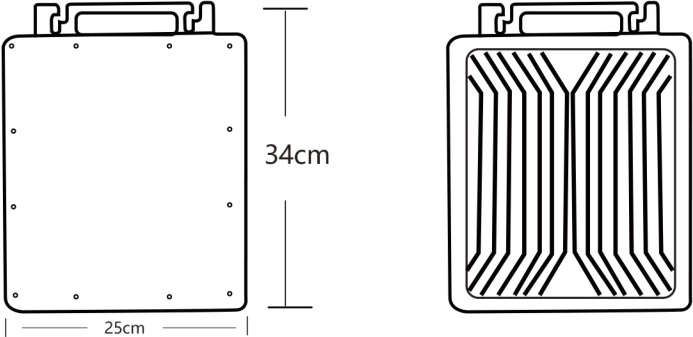

Input Data (DC, PV)

Number of Input MC4 Connector	4 sets
MPPT Voltage Range	22V-48V
Operation Voltage Range	18V-60V
Maximum Input Voltage	60V
Startup Voltage	22V
Maximum Input Power	1600W
Maximum input Current	15A*4

Output Data(AC)

Single-Phase Grid Type	120V&230V
Rated Output Power	1600W
Maximum Output Power	1600W
Nominal Output Current	@120VAC:13A/@230VAC:6.9A

Nominal Output Voltage	120VAC /230VAC
Default Output Voltage Range	@120VAC:80V-160V /@230VAC:180V-270V
Nominal Output Frequency	50Hz / 60Hz
Default Output Frequency Range	@50Hz:48Hz-51Hz/@60Hz:58Hz-61Hz
Power Factor	>0.99%
Total Harmonic Distortion	THD <5%
Maximum Units per Branch	@120VAC:2units /@230VAC: 3units

Efficiency

Peak Efficiency	95%
Nominal MPPT Efficiency	99.5%
Night Power Consumption	<1w

Mechanical Data

Operating Ambient Temperature Range	-40°C to +65°C
Storage Temperature Range	-40°C to +85°C
Dimensions(W*H *D)	250mmx34mm x 45mm (not include connectors and cable)
Weight	3.65kg
Max Current of AC Bus Cable	20A
Waterproof Grade	IP66
Cooling Mode	Natural Convection- No Fans

Other Features

Communication	WIFI(Cloud monitoring)
Transformer Design	High Frequency Transformers,Galvanically Isolated
Integrated Ground	Equipment ground is provided by the PE in the AC cable. No additional ground is required.
Protection Functions	Isolated Island Protection,Voltage Protection, Frequency Protection, Temperature Protection,Current Protection, etc.
Design Compliance	EN IEC61000-3-2:2019+A1:2021, EN 61000-3-3:2013+A1:2019+A2:2021, EN IEC55014-2:2021,EN IEC55014-2:2021,

Single phase connection method of micro inverter

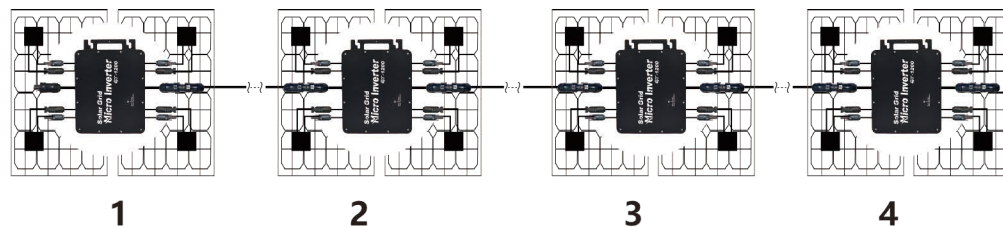

- 1.@Single-Phase 230V gridMaximum 4 units 1600W Microinverters per branch.
- 2.The max DC input power of each inverter is 1600W(the PV module max output power is 4x400W)
3. The VOC of PV modules should not be greater than the max DC input voltage of Microinverters.

Single phase connection method of micro inverter

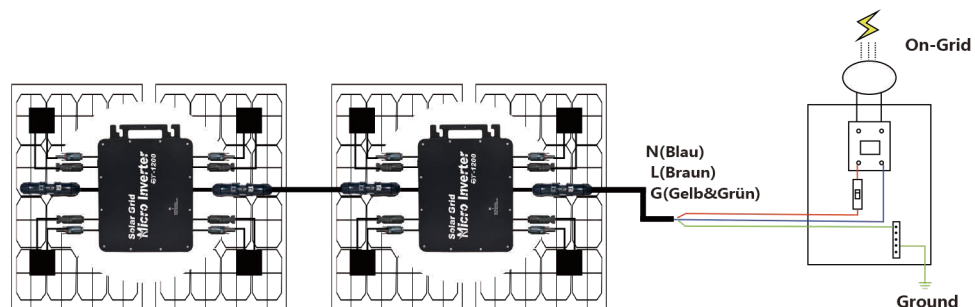

Three phase connection method of micro inverter

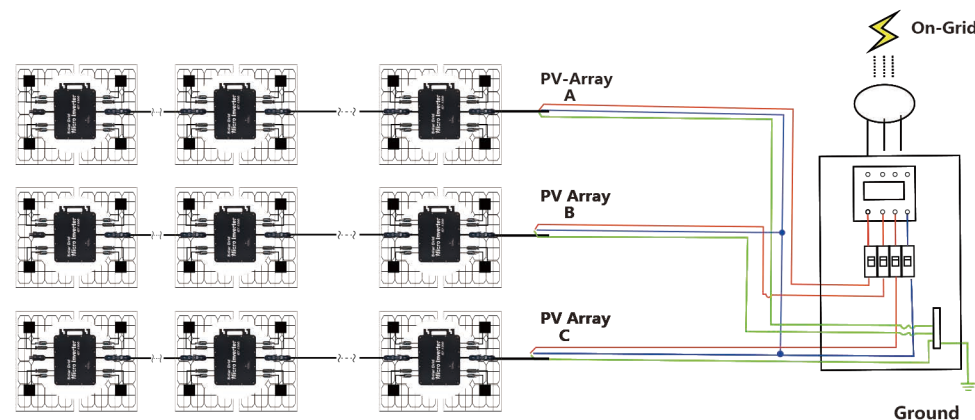

# Micro Inverter 350/400/600/800/1200/1400/1600

## WiFi Cloud Monitoring User Manual



### Configuration Steps Of WiFi Cloud Monitoring

#### READ ME FIRST

\*\* User manual subject to change without notice\*\*

- Note that there is a risk of electric shock when connecting the micro-inverter!
- The micro-inverter heats up during operation! Protect yourself accordingly from burns!
- Before configuring WiFi cloud monitoring, please correctly install the micro inverter and make it work normally
- A smart device (smartphone or tablet) with Bluetooth function and Android or iOS system and a wireless network device, e.g. wireless router that can provide WiFi and Internet service must be available
- To configure WLAN cloud monitoring, first switch on the Bluetooth function of the smart device.
- Make sure that your smart device uses the same WiFi network as the micro inverter to be configured and that it can connect to wireless network devices and access the Internet in the same location of the micro inverter
- Make sure that the distance between the wireless network device and the micro-inverter does not exceed 20 m and that there are no or few obstacles

#### Hardware Description



#### WiFi Status LED Display

- The blue light flashes after always on = the WiFi cloud monitoring module is waiting for configuration.
- The blue light off after always on = the WiFi cloud monitoring module starts and enters the normal working state.
- The blue light flashes = the network is not configured or the network cannot connect to the wireless network device, or the micro inverter has been deleted in the cloud.
- No light = WiFi cloud monitoring is working normally.

#### Preparation Before Configuration And Use

1. Install the micro inverter correctly and make it work normally to generate power.
2. Download and install the or "Smart Life" app by searching for it in the corresponding Android or Apple app store.
3. Turn on the Bluetooth function of your smart device .
4. Check that your wireless network device (such as wireless router) is working properly and connected to the Internet.
5. Use your smart device (with "Smart Life" App installed) at the installation location of micro inverter to connect to the wireless network device. If you can access the Internet normally, follow the instructions for configuration and usage on the next page.



- 1 Download in mobile application: smartlife or direct code scanning
- 2 Register personal account
- 3 Restore factory settings Press and hold the red key for 5-10 seconds and release it. The blue light is flashing and the instrument is connected successfully
- 4 Add inverter

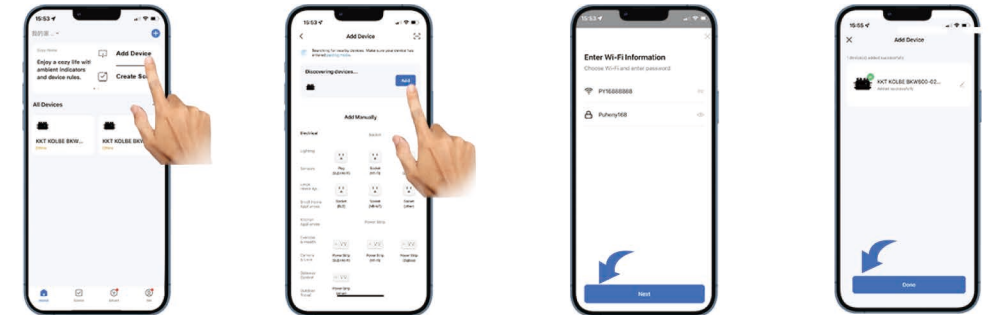

- 5 Further add confirmation information
- 6 Make sure the phone is in Bluetooth on or WiFi status
- 7 Enter your home WiFi account information password
- 8 Click Next to install and modify the name and account freely





- 9 The interface can control the system switch normally. The connection is successful



- 10 The connection is successful, and the green light of the inverter is always on in normal operation. Occasionally flashing instrument MPPT is tracking the optimal voltage

Modify Device Name

1. Click the device to be modified in the device list on the home page to enter the device information details page (Figure 5).
2. Click the button  in the upper right to enter the device setting page (Figure 6), Continue to click the upper button  to the page of name & position (Figure 7) click name item, then enter a new name and save it (Figure 8).

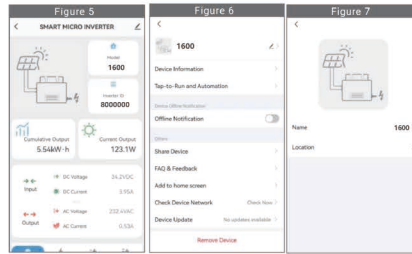

Remove Device

1. Click the device to be deleted in the device list on the home page to enter the device information details page (Figure 5).
2. Click the button  in the upper right to enter the device setting page (Figure 6). Click "Remove Device" button below (Figure 9), click the "Disconnect" button to remove the device or click the "Disconnect and wipe data" button to remove the device and clear all data saved by the device in the cloud at the same time.

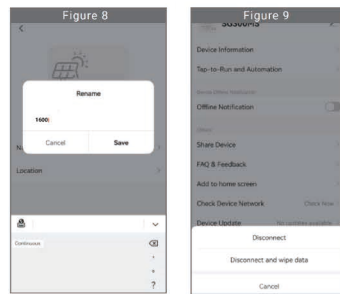

Share Device With Others

1. Click the device to be shared in the device list on the home page to enter the device information details page (Figure 5).
2. Click the button in the upper right to enter the device setting page (Figure 6).
3. Click the "Share Device" item to enter the device sharing page (Figure 10), click **Add Sharing** button to enter "Add Sharing" page (Figure 11), and select best sharing way that you think it is most convenient to share the link of micro inverter.

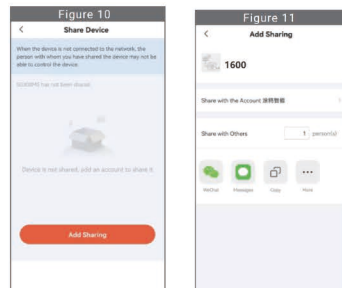

AC-Hauptkabel

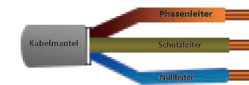

L-Phasenleiter (Braun)

G- Schutzleiter (Gelb & Grün)

N-Nullleiter (Blau)

1. The installation process of fixing inverter to PV bracket with mounting screws is as follows:

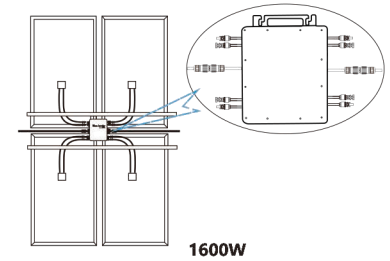
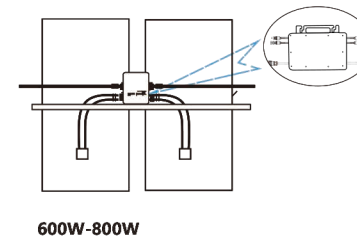

2. Connect the DC of PV to the inverter, and pay attention to distinguish between positive and negative, as shown below:

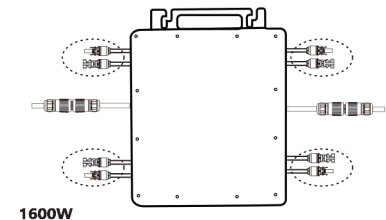
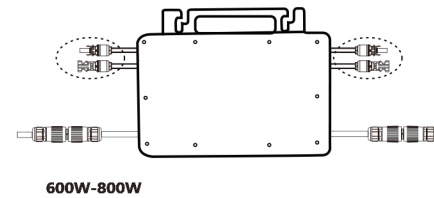

3. Open the waterproof cover on the AC output side of the micro inverter, and then connect it to the AC. As follows:

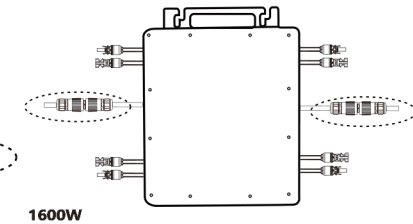
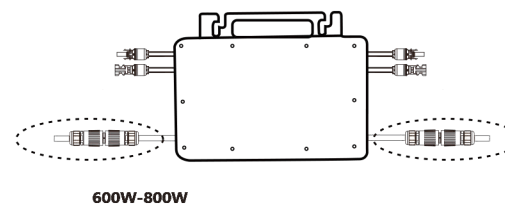

4. Repeat steps 1 to 3 to complete the installation of the micro inverter.

5. Connect multiple inverters through AC output cables.

6. The AC main cable is connected to the power grid.

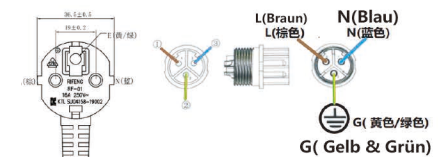

## Structure of Solar power system

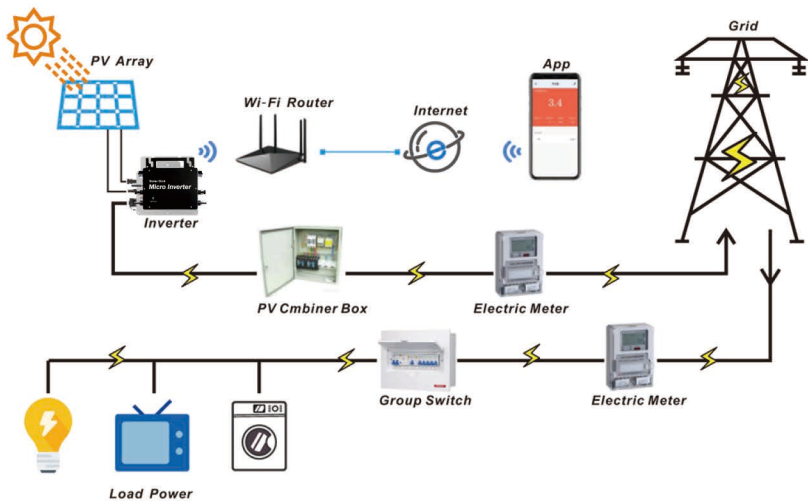

## APP connection



## connection

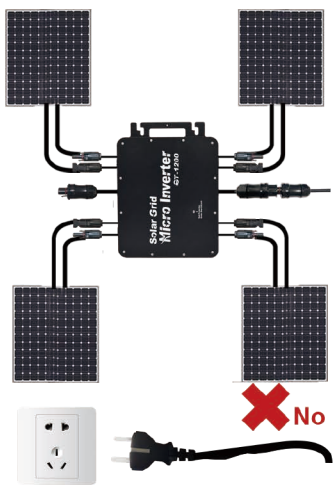

Only the solar panel is connected. When the mains AC is not connected, the red light on the inverter surface is on, and the instrument and machine do not work normally

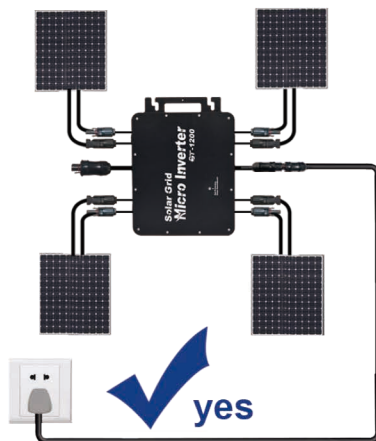

Normal working conditions of the inverter: the 22-50V DC voltage of the solar panel must be connected, and the AC voltage must be connected at the same time, and the indicator light is green

When the inverter is purchased for the first time and connected to the mobile phone for monitoring, it is only necessary to switch on the mains AC, the blue light beside it flashes, and the inverter can be connected through WIFI or Bluetooth pairing. When the inverter can be controlled through the mobile phone, it is indicated that the connection is normal.



**Read user manual before operating this equipment, because failure could result in serious injuries, property damage and / or electrical shock.**

- The inverter ONLY works when it is connected to the grid. If the unit is unplugged, there is no feed-in. There is no voltage at the output and the indicator light lights up red.
- The maximum voltage and wattage of all connected PV panels must NOT exceed the max. voltage and wattage of the inverter, otherwise the unit will be damaged. Please refer to the technical data.
- Before maintenance work, the PV panels and all connections must be disconnected from unit.
- The unit may only be opened by qualified personnel.
- The current generated by the PV modules cannot be switched off. To do this, disconnect the panels from the inverter. There is a danger of electric shock.
- Do NOT remove the lid. Servicing must be performed by qualified service personnel.
- Protect the inverter from direct sunlight and rain, e.g. by mounting it behind a PV panel.
- Do NOT cover the unit as it may overheat.
- NOTE: Unused connections must always be closed, otherwise water may enter and a shortcircuit may occur.



**1. WHAT TO DO when the Smart-App can't find the micro inverter to be added?**

Check the following points:

- Check if the WiFi status indicator of the micro inverter is in the "Blue Flashing" state;
- Check if the Bluetooth function of your smart device is turned on;
- Check if the signal of the wireless network is good.

If all this is the case and the inverter is still not found, press the red reset button for more than 5 seconds to reset. After the WiFi indicator light flashes blue again, use "Smart Life" App to reconfigure the network.

**2. WHAT TO DO if I have multiple micro inverters to configure?**

Install all micro inverters properly and make them work normally to generate power, and then operate according to the configuration and use steps. The App can search all inverters to be added at one time and configure them at one time.

**3. WHAT TO DO if the SSID of my WiFi network or the password is changed?**

Please reconfigure the inverter according to the configuration and use steps.

**4. WHAT TO DO if the WiFi status indicator of the inverter goes out, but the device displayed on the app is not online?**

This means that you can connect to the wireless network device, but you can't connect to the cloud server. It means that your wireless network device can't connect to the Internet. Make sure that your Internet is working properly.

**5. The installation site of the inverter is temporarily not equipped with a router and no WiFi signal.**

How does App connect the inverter and detect if the inverter is working properly?

You can use an idle smartphone to open the WiFi sharing of mobile phone signal hotspot for connection, and reconfigure the network connection after installing the router.

**6. There are multiple WiFi signals on site. Can we connect with different WiFi signals?**

No, the WiFi connected of the micro inverter and the smart phone must be consistent before the network can be configured.

**7. Can App configure the micro inverter in different places? Can I view data in different places?**

You can't configure the micro inverter in different places, but you can view data in different places. The inverter uploads the latest status data to the cloud server every minute.

**8. After checking that there is no problem, the App still cannot find the micro inverter.**

Press and hold the inverter red button for more than 5 seconds to reset the inverter.

After the WiFi indicator flashes again, use App to reconfigure the network.

**9. WHAT TO DO if I want to monitor the same inverter on two or more smart devices?**

You can share the inverter with another phone using the share device feature.

**10. Will App data be saved?**

Yes, App data will be stored on cloud server. After the network is successfully configured, you can view the data at any time and place.

**11. The inverter cannot be connected to the app at night?**

At night, because the solar panel does not generate power, the micro inverter does not have any power input, so it will offline and it is impossible to re-configure the network at night.