



10 Degree dual tilt

- Maximal area utilized
- Maximal PV quantity installed
- SunEvo E-W 10 is for solar installed on a flat roof, for maximized roof space utilized, and PV quantity installed.
- All parts are made of extruded aluminum, with stainless steel 304 fasteners
- EPDM foam tape is installed at the bottom of the system, separated the roof and system.
- EPDM foam tape provides better friction, and compensates for the height difference when the roof is uneven.

Technical features:

Product name	E-W 10
Application	Flat roof
Tilt	10°
System Material	extruded aluminum profile 6005 T5
Fastener material	Stainelss steel 304
Finish	Anodized
Module orientation	Landscape



1 Assembly

ERK-AIC



ERK-FEC



ERK-BPF-10



ERK-BPF-10

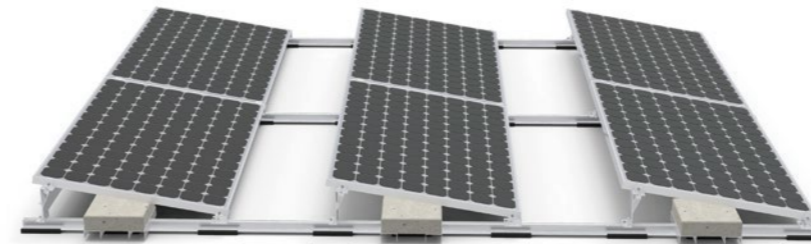

10 Degree tilt

- Better panel output
- The SunEvo S Ballast is for solar PV to be fast and easily installed on a flat roof with 10 tilt degree inclination. All parts are made of extruded aluminum, with stainless steel 304 fasteners
- EPDM foam tape is installed at the bottom of the system, separated the roof and system.
- EPDM foam tape provides better friction and compensates for the height difference when the roof is uneven.

Technical features:

Product name	S 10
Application	Flat roof
Tilt	10°
System Material	extruded aluminum profile 6005 T5
Fastener material	Stainelss steel 304
Finish	Anodized
Module orientation	Landscape

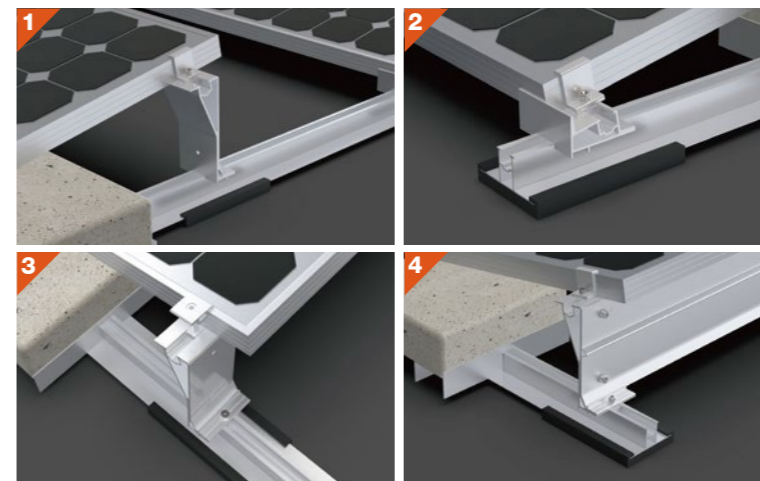

2 Assembly

ERK-R41-02



ERK-BST-02



ERK-SFR-04



ERK-EFT-03

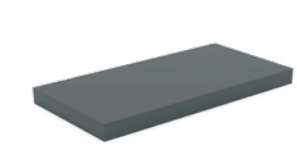

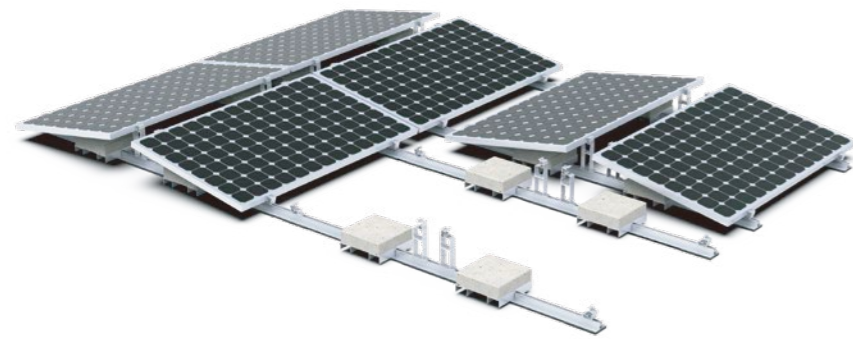

SunEvo East & West Ballasted-Ult Systems suitable for concrete flat roof and trapezoidal sheet metal roof. Unlike the traditional solar panel fixing method, whose fixing point at the end of the long side of the panel, this series help solar panels to be fixed anywhere on the long side. Therefore, solar panels could withstand greater wind and snow pressure. There is no need to use expansion bolts or chemical bolts on the roof, no damage to roof. The system connects all the panels with the rails into a whole. East-west facing panels have a great effect on resisting wind loads. A combination of high quality aluminium components make a robust, reliable system and quick and easy installation.

Technical features:

Product name	Ballasted-ULT Series
Application	Concrete flat roof and trapezoidal sheet metal roof Tilt: 10°
System Material	Extruded aluminum profile 6005 T5, EPDM
Fastener material	Stainless steel 304
Finish	Anodized
Module orientation	Landscape

1 Assembly

ERK-BUF-10



ERK-BUR-10



ERK-R41-02



ERK-BST-02

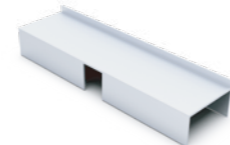

ERK-SFR-04



ERK-EFT-03

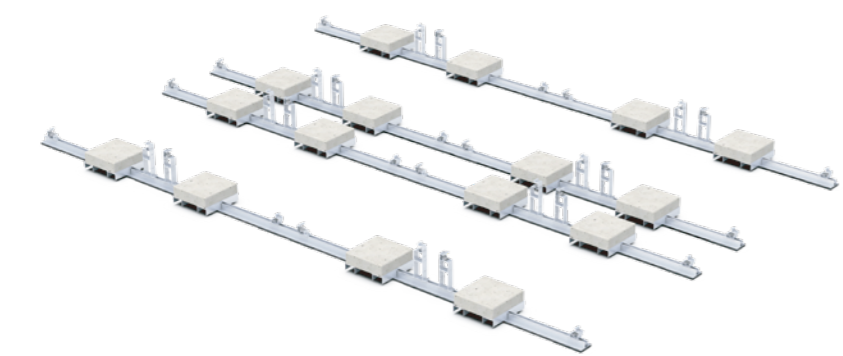
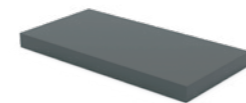

Product Feature:

Solar panels could withstand greater wind and snow pressure. Maximal area utilized. Maximal PV quantity installed. Maximized roof space utilized, and PV quantity installed. Better panel output.

Solar PV to be fast and easily installed on a flat roof with 10° tilt degree inclination. All parts are made of extruded aluminum, with stainless steel 304 fasteners. EPDM foam tape is installed at the bottom of the system, separated the roof and system. EPDM foam tape provides better friction and compensates for the height difference when the roof is uneven.



East & West 10° for concrete flat roof



South or North 10° for concrete flat roof



South or North 10° for trapezoidal sheet metal roof

