



Barcelona Manual

MidNite Solar Barcelona Owner's Manual



This entire manual is printed without color but is available for download—with many of the diagrams available in color—on our website at midnitesolar.com.



Barcelona Manual

Table of Contents

Introduction	3
Safety Instructions	4
How To KILL Your Batteries	6
Wiring Requirements	7
Installation	10
Barcelona Connections	12
Options Board.....	12
Bypass Switch	13
Arc Fault.....	14
Ground Fault.....	14
Rapid Shutdown System.....	15
Battery Temperature Sensor.....	16
Whiz Bang Jr	17
Battery Sense Circuit	18
Barcelona Wiring	18
Energizing the Barcelona	19
Operation	20
System and Device Naming.....	20
Battery Charge Stages	22
Advanced Settings and Concepts	23
Barcelona Programming	24
Auxiliary Modes	28
Firmware Update	30
Troubleshooting	31
Technical Drawings & Specifications	34
Warranty	39
PV Voltage Correction Factors	41



Barcelona Manual

INTRODUCTION

The Barcelona charge controller regulates a DC input source from solar to properly charge a 48VDC battery bank. The Barcelona can be installed stand-alone or as a multi-unit, networked installation with any CANBUS MidNite product using our latest graphical interface, the MNGP2.

Standard Features:

- 200A of charging current: 100A per MPPT channel
- Min/Max MPPT range: 185V to 550VDC
- Two independent MPPT input channels
- Installed Options Board for:
 - Arc Fault Protection, UL1699B
 - Ground Fault Protection, NEC2020
 - SunSpec compliant Rapid Shutdown Transmitter
- Compatible with flooded lead-acid, sealed, AGM, Gel, NiFe, Lithium, and virtually any other battery chemistry
- Two AUX circuits for remote triggering
- Dedicated Whiz Bang Jr input terminal
- Remote Battery Voltage Sense Circuit
- MidNite Graphics Panel (MNGP2)
- Operating voltage: 29V to 65VDC
- Battery Temperature Sensor
- CANBUS communications
- Data logging for 365 days
- Voice annunciations
- 48VDC battery bank
- Bluetooth
- ETL Listed



Pre-Wired Barcelona and Breaker Box ...
Includes PV and Battery breakers, SPDs (not shown), and mounting backplate.



Barcelona Manual

IMPORTANT SAFETY INSTRUCTIONS SAVE THESE INSTRUCTIONS

THIS MANUAL CONTAINS IMPORTANT INSTRUCTIONS FOR THE MIDNITE SOLAR BARCELONA MPPT CHARGE CONTROLLER THAT SHALL BE FOLLOWED DURING INSTALLATION AND OPERATION.

If you do not fully understand any of the concepts, terminology, or hazards outlined in these instructions, please refer installation to a qualified dealer, electrician, or installer. These instructions are not meant to be a complete explanation of a renewable energy system. Before using the Barcelona, read all instructions and cautionary markings. The installation instructions are for use by qualified personnel only. Do not perform any installation other than that specified in this manual unless you are qualified to do so. Incorrect installation may result in a risk of electric shock, fire, or other safety hazard.

Safety Symbols

The following safety symbols have been placed throughout this manual to indicate dangerous and important safety instructions.

WARNING!

WARNING indicates a hazardous situation which, if not avoided, could result in death or serious injury.

CAUTION!

CAUTION indicates conditions or practices that could result in damage to the unit or other equipment.

INFO: Indicates information that emphasizes or supplements important points of the main text.

SAFETY PRECAUTIONS

- Over-current protection for the DC wiring is not provided as an integral part of this charge controller. Over-current protection of the DC wiring must be provided as part of the system installation.



Barcelona Manual

- System grounding is the responsibility of the system installer and must comply with local and national electrical codes and standards.
- This product is designed for indoor/compartment installation. It must not be exposed to rain, snow, moisture, or liquids of any type.
- Listed or labeled equipment shall be installed and used in accordance with any instructions included in the listing or labeling.
- All work must be performed in accordance with local and national electrical codes.
- The DC negative conductors are not connected (bonded) to the charge controller's chassis.
- Use Class 1 wiring methods for field wiring connections to terminals of a Class 2 circuit.
 - Barcelona's Class 2 terminals: WBJr, AUX, Current Transformers, BTS, CANBUS.
- Use insulated tools to reduce the chance of electrical shock or accidental short circuits.
- Torque all wiring and cable connections to the required torque values.
- Use only copper wires with a minimum temperature rating of 90°C.
- There are no user-serviceable parts contained in the Barcelona.
- Always verify proper wiring prior to energizing the Barcelona.
- Battery cables should be no less than **#2/0 AWG**.
- Properly mount the Barcelona.

BATTERY SAFETY

- Wear eye protection and avoid touching your eyes and face when working with batteries to keep any fluid/corrosion on the battery from contact with eyes and skin. Have plenty of fresh water and soap nearby and thoroughly wash in case battery acid contacts skin, clothing, or eyes. In the event of exposure to the eyes, flood them for at least 15 minutes with running water and seek immediate medical attention. Baking soda neutralizes lead acid battery electrolyte and vinegar neutralizes spilled NiCad and NiFe battery electrolyte; depending on your battery type, keep a supply on hand near the batteries.
- Read and follow the battery manufacturer's safety precautions before installing the inverter and batteries. Always verify proper polarity and voltage before connecting the batteries to the Barcelona. Once the batteries are connected, ensure the maintenance and charging requirements (i.e., charge voltage and charge rate) provided by the battery manufacturer are followed to extend the life of the batteries and to prevent damage to the batteries while charging.
- The battery bank should be installed in a clean, dry, ventilated environment that is protected from high and low temperatures. If installed in a vehicle/boat, the batteries must be mounted upright (if using liquid batteries) and securely fastened. The location must be fully accessible and protected from exposure to heat producing devices, and away from any fuel tanks.
- Batteries can produce explosive gasses, so install batteries in a well-ventilated area. For compartment or enclosure installations, always vent batteries from the highest point to the



Barcelona Manual

outside. Design the battery enclosure to prevent accumulation and concentration of hydrogen gas in pockets at the top of the compartment.

- Remove all jewelry such as rings, watches, bracelets, etc., when installing or performing maintenance on the batteries and inverter. A battery can produce a short-circuit current high enough to weld metal jewelry, causing severe burns.
- Use insulated tools and be very careful when working around batteries, they can produce extremely high currents if short-circuited (e.g., dropping a metal tool across the battery terminal), which could cause a fire or explosion.
- To prevent a spark at the battery and to reduce the chance of explosion, turn off (open) the DC battery breaker, install/connect the positive DC cable to the breaker, then connect the positive DC cable to the battery bank. With the DC breaker off/open, connect the negative DC cable to the battery bank and the Barcelona.
- Never work alone. Always have someone within the range of your voice or close enough to come to your aid when working around batteries.
- Never use old or untested batteries. Check each battery's label for age, type, and date code to ensure all batteries are identical.
- Batteries are sensitive to changes in temperature. Install batteries in a stable environment.
- Provide at least one inch of air space between batteries to provide optimum cooling.
- Use proper lifting techniques when working with batteries.
- Never smoke or allow a spark near batteries.
- Never charge a frozen battery.

STANDARDS

The MidNite Solar Barcelona charge controller conforms to *UL 1741, Safety for Inverters, Converters, Controllers and Interconnection System Equipment for Use with Distributed Energy Resources, UL 1741:2010 Ed.2+R:15Feb2018; CSA C22.2#107.1:2016 Ed.4.*

HOW TO **KILL** YOUR BATTERIES

Batteries are delicate and require proper attention, especially when off-grid. Think of your batteries and solar equipment as a small nuclear power plant, hydro dam, or natural gas-fired power plant. Just like any of those, your system needs DAILY attention to ensure it is performing correctly and safely. We recommend the use of an independent battery monitor/alarm if you have an expensive battery bank. Below is a list of some of the most common ways we have seen people kill their battery bank.

- Using more than three parallel strings and not using common bus bars. With lead-acid batteries, when you use more than three strings, it is very hard to properly charge the middle strings. The only safe way to do this is to wire each string with equal length cables to a common bus bar. Connect inverter cables to the farthest points on the busbars.
- Not watching to verify the Absorb or EQ times are set properly and that the equipment



Barcelona Manual

actually charges for that period of time. Some equipment will have settings like “End Amps” that can terminate Absorb early and, if set up wrong, can damage a battery.

- Not using ALL EQUAL LENGTH interconnect cables on each string. It is important that ALL strings be wired EXACTLY the same. Any variance in resistance on one string versus another will cause an imbalance and the batteries will suffer a shortened lifespan.
- Trusting a State of Charge (SOC) meter, which can lose calibration over time and give you false readings. You need to verify specific gravity and or verify the charge voltage is being met. Never fully rely on the SOC %; it is just a good, quick reference.
- Routinely using more than 50% of the capacity of the lead acid battery. Using more than half the battery capacity drastically shortens the batteries life; occasionally is fine, but daily will kill lead acid batteries in months.
- Not leaving ample space between cells for cooling. We recommend at least one inch between the cells for cooling. Ask the battery manufacturer what they recommend.
- Not having enough charge current to properly charge the size of the battery you have. Consult the battery manufacturer for the minimum charge current.
- Using tap water or other liquids instead of distilled water in a flooded battery. The minerals in the tap water will destroy a battery.
- Not verifying the temperature compensation neutral point (typically 25°C) and the milli volts per degree C per cell (typically -5mV).
- Not verifying you are charging to the voltage supplied by the battery manufacturer.
- Not fully charging your lead acid batteries at least once a week.
- Failing to keep all connections clean.

WIRING REQUIREMENTS

- The NEC (*National Electric Code, ANSI/NFPA 70*) for the United States and the CEC (*Canadian Electrical Code*) for Canada provide standards for safely wiring residential and commercial installations. The NEC/CEC lists the requirements for wire size, overcurrent protection, and installation methods.
- Do not mix AC and DC wiring in the same panel unless specifically approved/designed for both AC and DC wiring. Where DC wiring must cross AC or vice-versa, try to make the wires at the crossing point perpendicular (90 degrees) to one another.
- DC wires to and from the Barcelona must be protected as required by code. This can be done by using jacketed wires or by feeding the wires through conduit or a conduit box. The optional Barcelona Breaker Box satisfies this requirement.
- Always check for existing electrical, plumbing, or other areas of potential damage prior to making cuts in structural surfaces or walls.
- Wiring should meet all local codes and standards and be performed by qualified personnel such as a licensed electrician.
- DC over-current protection must be provided as part of the installation.
- Use only copper wires with a minimum temperature rating of 90°C.



Barcelona Manual

- The equipment ground is marked with this symbol: 

CAUTION!

The Barcelona is designed for indoor installation or installation inside a weatherproof enclosure. It must not be exposed to rain and should be installed out of direct sunlight.

WARNING!

Ensure all sources of DC power (i.e., batteries, solar, wind, or hydro) are de-energized (i.e., breakers opened, fuses removed) before proceeding—to prevent accidental shock.

DC Wiring

- Minimize the number of connections between the Barcelona and the battery bank. Exceptions are the DC breaker—required at the battery to protect the DC wiring—in the positive line, and a DC shunt—to allow battery charge state monitoring—in the negative line. Additional connections will contribute to voltage drops, and these extra connection points may loosen during use.
- The DC cables/wires must be color coded with colored tape or heat shrink tubing: RED for positive (+); WHITE for negative (-) if solidly grounded ; BLACK if reference grounded (using a GFP breaker); and GREEN for DC ground.
- All wiring to the battery terminals should be checked monthly for proper torque/tightness. If you don't have a torque wrench, ensure all DC terminals are tight and cannot move.
- Use the correct DC cable and corresponding circuit breaker to achieve maximum efficiency from the system and reduce fire hazards associated with overheating.
- The DC cables must be fine strand, super flexible, such as Cobra cable (or equivalent) and be approved for residential wiring per the NEC (THW for example).
- Do not use the Barcelona chassis in place of the battery negative connection for grounding. A reliable return path directly to the battery is required.
- PV negatives must stay isolated from Battery negative. Wire PV negative directly to the Barcelona's MPPT PV input terminal block.
- Install a **200A** DC breaker between the Barcelona and the battery bank on the positive cable. Use **#2/0 AWG battery** cables.
- A readily accessible battery disconnect is required and must be located within sight of the battery system (NEC 480.7).
- Ensure both DC cables pass through the same knockout and conduit to allow the inductive currents to cancel.



Barcelona Manual

- All wiring to the battery terminals should be checked periodically (once a month) for proper tightness.
- Ensure cables have a smooth bend radius and do not become kinked.
- Limit cable length to 6' or less from Barcelona to battery bank.
- **The battery bank voltage MUST be 48V!**

WARNING!

Verify correct polarity with a multimeter **BEFORE** connecting battery cables to Barcelona.

DC Over-Current Protection

- The NEC requires both over-current protection (UL489 standards) and a disconnect switch. If a circuit breaker is used as the over-current protection device, it can also be used as the required DC disconnect. If a fuse is used as an over-current device, a Class-T type or equivalent is highly recommended. This fuse type is rated for DC operation, can handle high short-circuit currents, and has a time delay that allows for momentary current surges without opening the fuse. Because the fuse can be energized from both directions, the NEC requires that it be installed in a manner that the power must be disconnected on both ends of the fuse before servicing.
- The DC over-current protection device must be installed on the positive DC cable and it must be correctly sized according to the size of DC cables being used, which means it is required to open before the cable reaches its maximum current carrying capability.
- **Use a 200A DC breaker.**

Grounding

- The negative battery conductor should be solidly bonded to the grounding system at only one point in the system. The size for the conductor is determined by the size of the largest phase conductor, per the NEC/CEC.
- Use **#6 AWG** grounding electrode conductor.

CAUTION!

The Barcelona may be used in a positive, negative, or ungrounded system. For a grounded system, bond either Battery Negative to Ground, or bond Battery Positive to Ground (but not both at the same time!!).

Arc Fault - The NEC requires any PV system DC circuit operating at 80VDC or greater must be protected by an arc fault (AF) circuit interrupter.

Ground Fault - Since 2008 the NEC requires a DC Ground Fault (GF) Protection device on all PV systems to indicate when a GF condition exists.



Barcelona Manual

Protecting Wire – Barcelona Breaker Box (MNBLNA BB)

DC wires to and from the Barcelona must be protected as required by code. This can be done by using jacketed wires or by feeding the wires through conduit. Midnite offers a breaker box that includes the necessary DC breakers that allow the PV wires and DC battery cables to be routed via conduit and connected to the Barcelona.

PV Array

- The PV array connected to the Barcelona must be designed to present enough voltage to operate, yet not enough to damage the unit. **The Barcelona needs a minimum of 240Voc from the PV array; otherwise, the controller will remain in a Resting state on a hot day.** Thus, when you design the PV layout, ensure you wire enough PV modules in series to present at least 240Voc. Since this is a 600V controller, you will more than likely wire many modules in series to take advantage of the 600V input. Be mindful of the effects of cold temperatures on PV string voltages. **DO NOT PRESENT MORE THAN 600VDC TO THE CONTROLLER!!** The MPPT range of the Barcelona is 185V – 550VDC. Page 41 shows an ambient temp chart to help size the PV string voltage.

EXAMPLE - Assume the coldest weather in your locale is -4F. Referencing the chart gives a factor of 1.18. $600Voc / 1.18 = 508Voc$. Thus, wire the PV modules in series so as not to exceed 508Voc and the MPPT will continue charging down to -4F.

- The PV negative wire from the PV array must be isolated from ground. Ensure the PV negative is wired from the array directly to the PV negative input terminal in the Barcelona.

CAUTION!

The PV negative from the PV array must be wired directly into the Barcelona.

Do **NOT** bond PV negative to ground. Do NOT exceed 600V IN!

INSTALLATION

Before installing, read the entire installation section to determine how you are going to install your Barcelona. The more thoroughly you plan in the beginning, the better your overall system needs will be met.

The installation begins by selecting a wall. The Barcelona is indoor rated and should not be placed outside unless precautions are taken to keep rain and moisture off the system.

The NEC requires 30" clear on the wall. The Barcelona may be located anywhere within this 30". The NEC also requires 36" free and clear of obstructions in front of the charge controller. The 36" clear area in front of all electrical panels is to provide a space to fall back into in case of electrical shock.



Barcelona Manual

The optional Barcelona Breaker Box offers NEC required OCP and DC disconnects but is NOT a required component. The Barcelona may be installed without the Breaker Box.

Mounting Location

Install the Barcelona in a location that meets the following requirements:

- Locate the charge controller as close to the batteries as possible. Long DC wires tend to lose efficiency and reduce the overall performance of a charge controller. However, the unit should not be mounted where it will be exposed to gases produced by the batteries. These gases are corrosive and will damage the Barcelona; also, if these gases are not ventilated and if allowed to collect, they could ignite and cause an explosion.
- Ensure the charge controller is accessible after it is mounted. Control buttons are located on the front of the unit. You will need to access these buttons to program and monitor its operation.
- The Barcelona weighs 23 pounds. The optional Barcelona Breaker Box weighs 12 pounds.
- The mounting surface and hardware must be capable of supporting at least twice the weight of these components.
- Mount at least 2' from any flammable or combustible fluid or components (i.e., paper, cloth, plastic, etc.) that may be ignited by heat, sparks, or flames.
- The area must be free from any risk of condensation, water, or any other liquid that can enter or fall on the Barcelona.
- Mount vertically on a flat, **non-combustible** surface.
- Remove knockouts before mounting.
- Plan any conduit runs now.

Mounting – Barcelona

1. Determine mounting location.
2. Hold Barcelona to wall, mark bolt holes; set Barcelona aside.
3. Install top two lag bolts to wall, leaving about ¼" exposed.
4. Align mounting flange keyhole of Barcelona (**Figure 1**) to the lag bolts, slide Barcelona down.
5. Install bottom two lag bolts.
6. Tighten lag bolts.

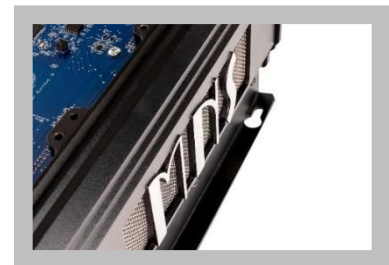

Figure 1



Barcelona Manual

BARCELONA CONNECTIONS (Figures 2, 3, & 4)

Terminal Block #1 - Breaker Trip circuits, connect to PV input remote-trip breaker(s). The Barcelona will signal the breaker to trip open when the PV input voltage exceeds 600VDC. Use **#22 AWG** wire.

CANBUS Receptacles #2 -Used to connect the Barcelona to other MidNite CANBUS circuits. Use standard RJ-45, CAT 5 cable. Use standard Ethernet cables; if length is in excess of 20 ft or in conduit with power wires, use shielded cable. If only using one of the two CANBUS terminals, then the unused terminal must have a terminator plug installed.

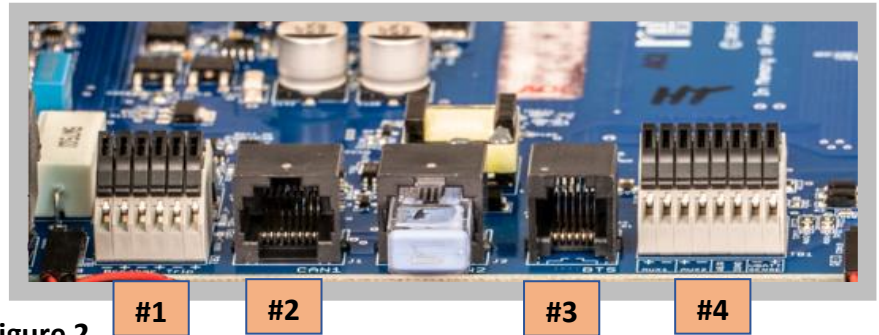

Figure 2

Battery Temperature Sensor (BTS) Receptacle #3 - Connect the BTS here. Only one BTS is required on a multi-Barcelona system. The Barcelonas will share battery temperature via CANBUS.

Terminal Block #4 - As marked, this terminal block is used with the AUX 1 and AUX 2 circuits; the Battery Voltage Sense circuit; and the Whiz Bang Jr, current-sense device. Use **#22 AWG** wire.

Terminal Block #5 (Figure 3) – PV input terminal blocks. Two input channels, two MPPTs.

Terminal Block #6 (Figure 3) – Connect the Battery Bank cables here. Use **#2/0 AWG** cables.

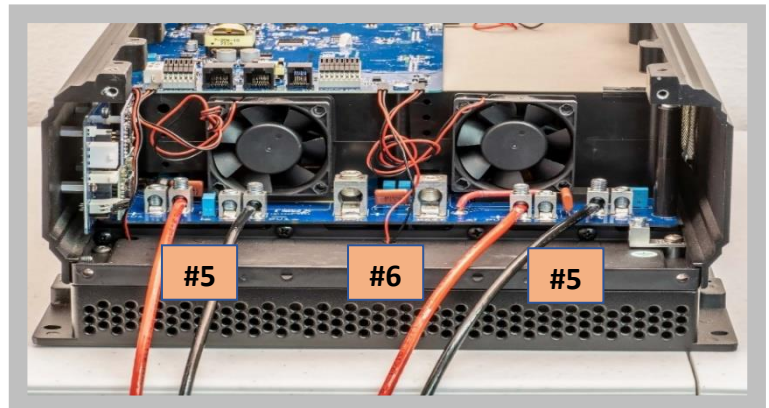

Figure 3

Equipment Ground Terminal (Figure 4) - Use **#6 AWG** wire.

Options Board

The Options Board is an installed circuit card that allows for the connection of Arc Fault, Ground Fault, and Rapid Shutdown System sensors (toroids).



Figure 4

Figure 5 shows the location of the Option Board installed in the Barcelona.

Figure 6 shows the Options Board, sub-boards, and connection receptacles.

Bypass Switch & TB1

For Rapid Shutdown System operations, the Barcelona via the Options Board can be configured to accept an external switch to initiate Rapid Shutdown.

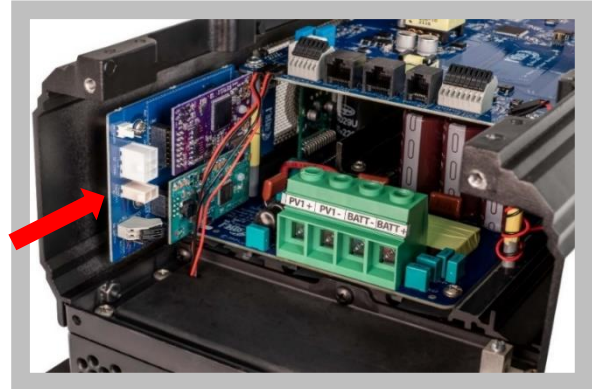

Figure 5

On the lower right corner of the Options Board is a Bypass Switch (CON4). To allow an external switch to control RSS, move the jumper to the JP2 position and connect the wires from the external switch into the RS Switch (TB1). TB1 is Normally Closed (NC); NC means no Rapid Shutdown. When input to TB1 becomes open, Rapid Shutdown is initiated. For internal MPPT initiation of Rapid Shutdown, move the jumper to the JP1 position.

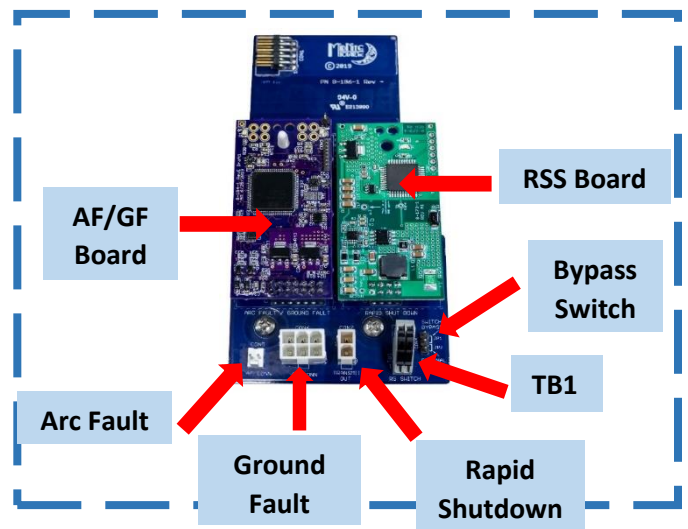

Figure 6

AF/GF Sub-board (Figure 7)

LEDs on the sub-board indicate:

- After boot-up (power on), **D2 (green)** should flash to indicate device is ready and working.
- If **D6 (red)** is flashing slowly, the device is either defective or coils aren't plugged in.
- If **D1 (red)** is on solid, then a GF is present.
- If **D5 (red)** is on solid, then an AF is present.

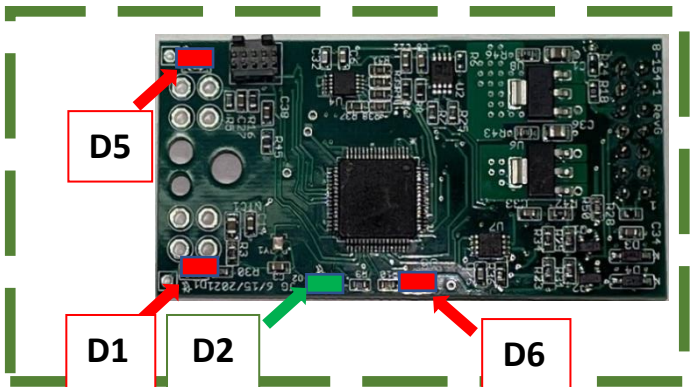

Figure 7

Normally the D2 LED will be green. However, some of the first production boards may have a red LED for D2 instead. For these boards, D2 flashing red indicates the device is ready and working - it does not indicate an error or issue with the Arc-fault board.

Arc Fault

The NEC requires that a PV system DC circuit operating at 80VDC or greater must be protected by an arc fault (AF) circuit interrupter. The Options Board satisfies this NEC requirement. There are no adjustments to be made for the AF system, other than ON or OFF. In the event the Barcelona detects an AF, the charge controller will shut down with audible and visual AF indications. The AF issue must be remedied before the controller can resume operations. Clear the AF, then power cycle the Barcelona off then back on.

Connecting the AF/GF sub-board to the Options Board:

1. The AF/GF sub-board (purple) connects to the top half of the Options Board. See **Figure 8**.
2. Align the pins of the sub-board to the Option Board's receptacle, **and**
3. Align the plastic support rod on the Options Board to the associated hole in the sub-board.
4. Gently seat the pins into the receptacle and the plastic support through the hole.



Figure 8

Connecting the AF toroid to the Options Board:

1. AF toroid shown in **Figure 9**.
2. Connect the AF toroid to the Options Board.
3. Pass both **PV-** wires through the AF toroid, as shown in **Figure 10**.



Figure 9

Activating Arc Fault:

1. Go to MPPT Config, then to External Sensors.
2. Go to AF, then ENABLE.

Ground Fault

Since 2008 the NEC requires a DC Ground Fault (GF) Protection device on all PV systems to indicate when a GF condition exists. For GF monitoring, you can either install the optional GF sensor (toroid) in the Barcelona or install an external GF breaker into your PV system.

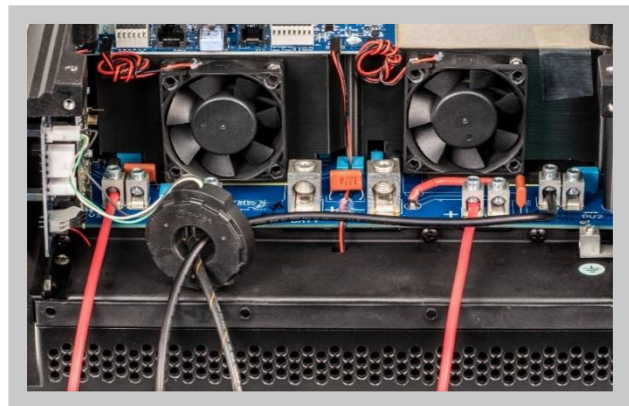

Figure 10

The Barcelona GF toroid works with either grounded or ungrounded PV systems. When a GF condition occurs, the Barcelona stops charging and announces a GF alert.

Connecting the GF toroid to the Options Board:

1. GF toroid shown in **Figure 11**.
2. Connect the GF toroid to the Options Board.
3. Pass all **PV+ AND PV-** wires through the GF toroid, as shown in **Figure 12**.



Figure 11

Activating Ground Fault:

1. Go to MPPT Config, then to External Sensors
2. Go to GF, then ENABLE.

Rapid Shutdown System

The NEC requires a Rapid Shutdown System (RSS) to be installed to reduce shock hazards to firefighters whenever PV system conductors are on or in a building other than a building whose sole purpose is to house PV system equipment. When initiated RSS lowers PV string- or module-level voltages to a prescribed voltage level in a prescribed timeframe. Basic RSS components include PV string or module receivers and a transmitter.

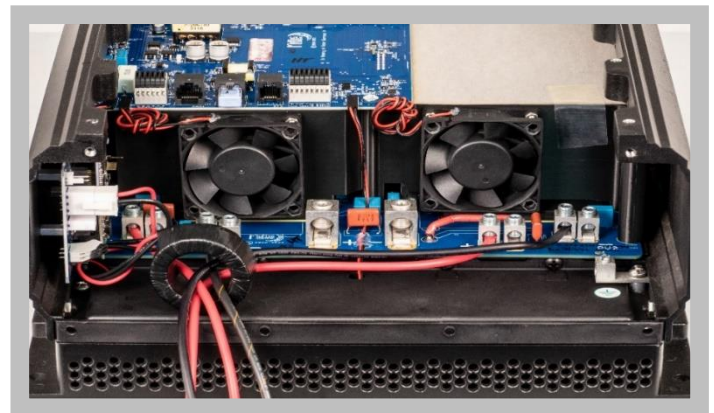

Figure 12

Connecting the RSS sub-board to the Options Board:

1. The RSS sub-board (green) connects to the bottom half of the Options Board. See **Figure 13**.
2. Align the pins of the sub-board (**#1**) to the Option Board's receptacle, and
3. Align the plastic support rod (**#2**) on the Options Board to the associated hole in the sub-board.
4. Gently seat the pins into the receptacle and the plastic support through the hole.

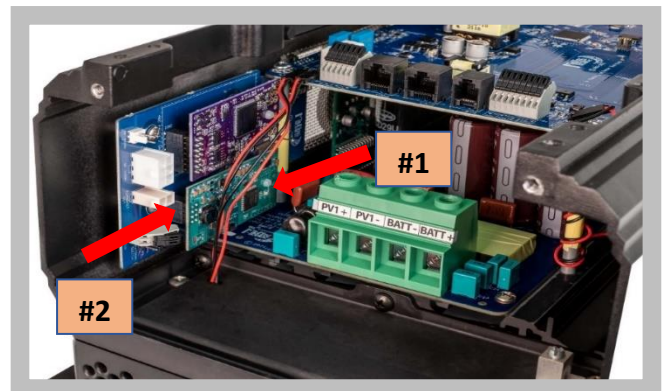

Figure 13

Connecting the RSS toroid to the Options Board:

1. RSS toroid shown in **Figure 14**.
2. Connect the RSS toroid to the Options Board.
3. Pass both **PV-** wires through the RSS toroid, as shown in **Figure 15**.

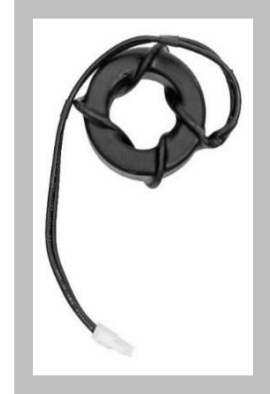

Figure 14

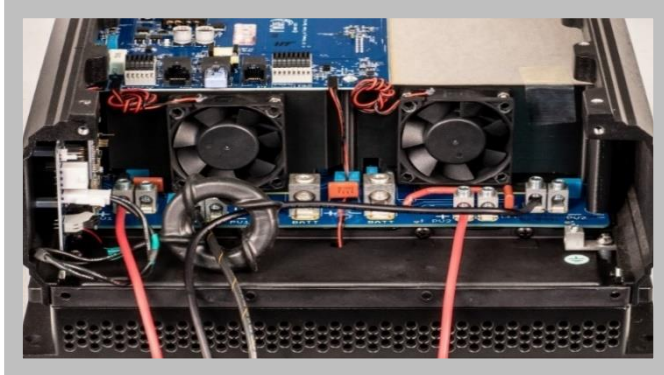

Figure 15

Ensure tab on toroid jack mates with the lock on Option Board receptacle.

When using all 3 toroids, stack the toroids in this order, closest to the terminal block:

- 1) GF toroid ... 2) AF toroid ...
- 3) RSS toroid.

Doing so will ensure proper fit within the Barcelona chassis.

See Figure 16.

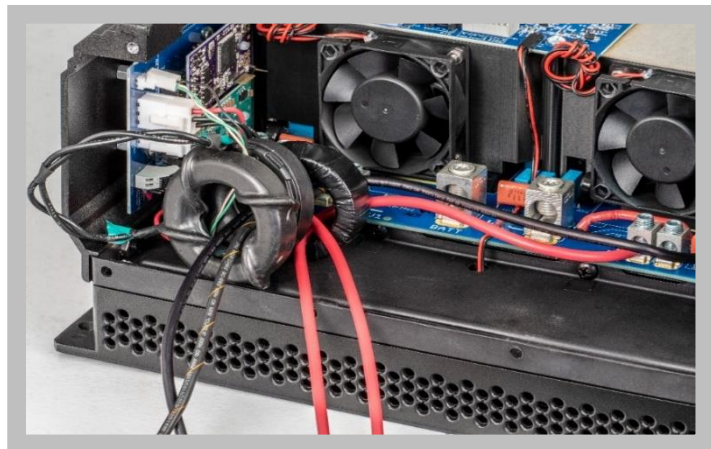

Figure 16

Battery Temperature Sensor

The Barcelona comes with a Battery Temperature Sensor (BTS). This sensor provides the battery's ambient (exterior battery casing) temperature to the charge controller, which is used to raise or lower the charge voltage setpoints relative to a reference temperature. Program the reference temperature as provided by the battery manufacturer; 25C is a common reference temperature. Program the temperature coefficient factor as provided by the battery manufacturer; -5mV is a common factor. If the BTS is disconnected or shorted, the Barcelona will default to a neutral temperature of 25C and will not temp-comp the charging voltages.

In addition to temp-adjusting the charging voltages as mentioned above, the Barcelona can be programmed to stop charging based on either a high or low battery temperature setpoint.

Connecting the BTS:

1. Connect the phone jack of the BTS into the BTS receptacle on the Barcelona control board, as marked by #3 in **Figure 2**.
2. Pick a battery in the middle of your battery bank. About halfway up the side of the selected battery case, clean that area, remove the protective tape, and affix the BTS sensor to the battery wall.

For double-wall battery case construction, consult the battery manufacturer for BTS sensor placement.

Whiz Bang Jr.

The Whiz Bang Jr (WBJr) is a current-sensing device that mounts to the side of a standard 500A/50mV shunt. The WBJr measures the current across the shunt into (and out of) the battery bank and reports this current flow to the Barcelona to be used in calculating an accurate State of Charge (SOC) percentage and to monitor for Ending Amps, which is a targeted setpoint to terminate the Absorb charge cycle.

The WBJr is mounted on the side of a shunt. The shunt is wired in series on the electric low side, or negative side, of your system. See **Figure 17**. The wire marked “Cable to Inverter Negative” shows the shunt connection point for **ALL** negative wires from charge controllers, inverter, wind turbine negative, and even a battery charger running off a generator. All negatives land there. The other shunt bolt connection is the single cable from the shunt to the battery bank’s master negative terminal.

Connecting the WBJr:

1. Connect the WBJr’s purple wire to the terminal block, #4, as shown in **Figure 2**.
2. Referencing **Figure 17**:
 - a. If the WBJr purple wire is pointing to the right as shown, then the shunt’s big right bolt is connected to the battery bank’s master negative terminal. There can **ONLY** be one wire connected to this shunt bolt.
 - b. Connect the inverter’s Batt- cable, the Barcelona Batt- cable, and all other DC- cables to the left bolt of the shunt.

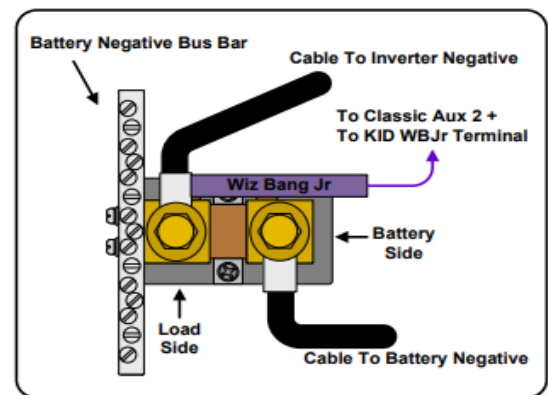

Figure 17



Barcelona Manual

The WBJr can be installed with the purple wire pointing left or right. BUT ... the battery negative cable must be on the same side as the purple wire!

Activating the WBJr:

1. In the Setup / Battery Config Menu, you need to program the following setpoints:
 - a. **Absorb Time** – Calculate the normal Absorb time then add one hour. This will ensure that enough time is allowed for Ending Amps to be achieved.
 - b. **Ending Amps** – Usually 1 – 3% of batt bank Ah capacity.
 - c. **Battery Capacity** – Batt bank’s 20-hr Ah capacity.
 - d. **Amp-Hour Efficiency** – Good starting point is 80% for flooded; 85% for sealed; 94% for Lithium.
2. Go to Setup / MPPT Config / External Sensors, then WBJr, and set to Battery.

Battery Sense Circuit

The Barcelona measures battery bank voltage via the Batt+ and Batt- cables connected to the battery bank, and it compares that measured voltage with the Battery Sense Circuit connection. If the Battery Sense voltage is within a pre-set range, the system will automatically use this voltage versus the voltage on the high current connections (the Barcelona’s actual battery cables). Only one Battery Sense wire connection to the battery bank is required for an entire system (i.e., multiple Barcelonas, Barcelonas, and/or Rosie inverter/chargers).

Connect two **#22 AWG** wires from the **#4** terminal block (See **Figure 2**) directly to the battery bank master positive and negative terminals. Install a **1A** fuse on the positive wire. Use the shortest length of wire possible. Crimp terminal lugs (ring connectors) on the ends that connect to the battery terminals.

BARCELONA WIRING (Figure 18)

PV

- Connect PV+ and PV- wires from PV array #1 to terminal block (**#1A**), **Figure 18**.
- Connect PV+ and PV- wires from PV array #2 to terminal block (**#1B**).
- If using wind or hydro, connect those DC wires to (**#1A**) or (**#1B**).
- Route PV- directly from the PV array to the Barcelona’s PV- terminal. **Torque.**

CAUTION!

The PV negative from the PV array must be wired directly into the Barcelona.

Do **NOT** bond PV negative to ground ... the GF sense circuit will not work.



Barcelona Manual

BATTERY

- Connect **#2/0 AWG** Batt+ and Batt- cables to terminal block (**#2**), **Figure 18**.
- For fine stranded cable, crimp a ferrule onto cables ends, then insert into the terminal block. Otherwise, insert bare wire into the terminal block. **Torque**.

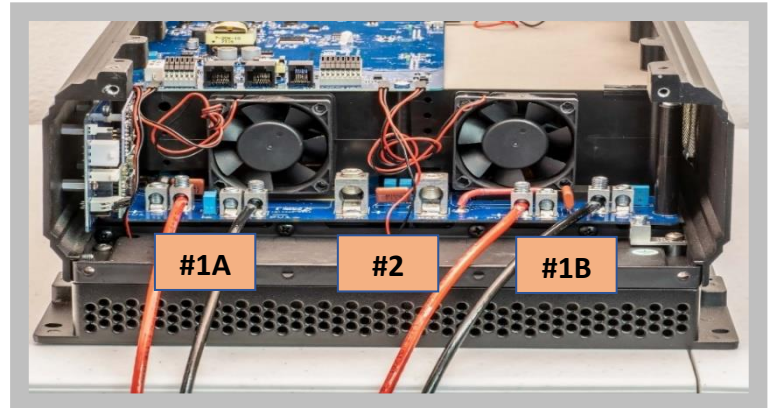

Figure 18

LITHIUM BATTERY WARNING!

If using Lithium batteries, the Barcelona’s battery circuit must be pre-charged.

TORQUE SPECS	
<u>PV Terminals</u>	<u>Battery Terminals</u> .. 120 in-lbs
#4-6 AWG 35 in-lbs	<u>Ground Terminal</u> 35 in-lbs
#8 AWG 25 in-lbs	
#10-14 AWG ... 20 in-lbs	

ENERGIZING THE BARCELONA

Read and follow the information below and the procedural steps listed by number to properly energize and test the charge controller.

Step #1 – Battery

Ensure all breakers are OFF You will need a multimeter

Voltmeter – Measure for battery bank voltage between the Barcelona battery breaker (at bottom of breaker) and the Batt- terminal inside the Barcelona.

- Battery bank voltage present?
 - **Yes** – Good (29-65VDC is good)



Barcelona Manual

- **No** – Check DC wiring to the battery. Check batteries.
- Close the Barcelona battery breaker.
- **Voltmeter** – Measure for battery bank voltage between the Barcelona Batt+ and Batt- terminals.
 - Battery bank voltage present?
 - **Yes** – Good. The Barcelona will automatically turn on now.
 - **No** – Check DC wiring or battery breaker.

Step #2 – Program Barcelona

- Depress the Setup button, highlight Battery Config, depress the rotary knob.
- Program per your battery specifications.

Step #3 – PV

- Connect or turn on the DC input (PV combiner – ON).
- **Voltmeter** – Measure each MPPT input for PV (open-circuit) voltage between left PV+ breaker (at the bottom terminal) and left PV- terminal (inside Barcelona).
 - PV voltage (Voc, open-circuit voltage) present?
 - **Yes** – Good ($\geq 240V_{oc}$ is good)
 - **No** – Check PV combiner breakers, PV wiring, or connections.
- Turn on (close) the PV breakers.
- **Voltmeter** – Measure each MPPT input for PV (max power) voltage between Barcelona PV+ and PV- terminals.
 - PV voltage (Vmp) present?
 - **Yes** – Good
 - **No** – Check connections, PV IN breaker, wiring; Is the Barcelona charging?

OPERATION

System and Device Naming

- There are two naming conventions in the Barcelona:
 - 1) Naming the device (Barcelona).
 - 2) Naming the system.
- One MNGP2 can control multiple CANBUS devices, such as the Barcelona, the Barcelona, and the Rosie inverter/charger. Therefore, one MNGP2 can look at each device by name.



Barcelona Manual

- System naming refers to pre-selected parameters that will be globally shared amongst the devices. For example ...
 - You buy one Barcelona with an MNGP2.
 - You name your device “Home Barc.”
 - You program “Home Barc” for your new Lithium batteries.
 - Then you buy a second Barcelona. You name the new device “Garage Barc.”
 - When Garage Barc is connected to CANBUS, it will automatically be programmed for the Lithium batteries, just like in Home Barc.
 - **BUT** ... if you bought/installed a device that was previously programmed by the prior user, when this device is connected to CANBUS, the MNGP2 will recognize there are now 2 system names (i.e., two completely different charging profiles), and you will be asked “Which system do you want?”
- During the naming process, the MNGP2 **Back** button means “Go Back,” and the **User** button means “Go forward.”
- Device Naming – Setup/MPPT Config/Set Name.
- System Naming – User/System Name
- To change battery chemistry – perform a factory restore ... Setup/MPPT Config/Reset to Defaults.

Maximum Power Point Tracking (MPPT)

- MPPT checks the output of the photovoltaic (PV) modules, compares that output to battery voltage, then fixes what is the best power the PV modules can produce to get maximum current into the batteries. Maximum power varies with solar radiation, ambient temperature, and solar cell temperature, and is most effective during cold weather.
- MPPT tracks and controls the Maximum Power Voltage, or V_{mp} , of the PV module(s). Whereas the Open Circuit Voltage, V_{oc} , is an important design consideration when determining how many PV modules to wire in a series string to an MPPT charge controller, V_{mp} is the voltage component and I_{mp} is the current component of the IV Power Curve. When an MPPT charge controller “sweeps” the power curve, this means the controller is looking at the point on the power curve in which V_{mp} is maximum.
- **V_{oc}** – Open Circuit Voltage: If the PV module is exposed to the sun, with both the positive and negative module wires disconnected, V_{oc} is the voltage you will measure with a multimeter. V_{oc} exists with daylight; V_{oc} is a function of light illuminating the PV module. When V_{oc} is maximum, current flow is zero.
- **V_{mp}** – Maximum Power Voltage: This is the highest voltage on the IV Curve; that is, with current now flowing from the PV module, this will be the highest point of voltage.
- **I_{sc}** – Short Circuit Current: With the same module above exposed to sunshine and the positive and negative wires connected to each other, with an ammeter you can measure I_{sc} . When I_{sc} is maximum, the voltage is zero.



Barcelona Manual

- **Imp** – Maximum Power Current: This is the current flow from the PV module at the Vmp point on the IV curve. When the Barcelona sweeps the IV curve and decides to lock on to a particular Vmp, then Imp is the current at this particular point of Vmp.
- Most PV arrays are, on average, about 80% efficient, or you can expect a 20% loss. To compensate, you can increase the PV array wattage by a factor of 1.25 ($1 / 0.80 = 1.25$).

Battery Charge Stages

- **Bulk** - This charging stage is called the Constant Current Mode, and it means the Barcelona will send to the batteries as much current as it can make until the battery voltage rises to the Absorb voltage setpoint.
- **Absorb** - Barcelona maintains the Absorb voltage setpoint until the batteries are charged. This stage is terminated at the end of the Absorb Timer or when the Ending Amps setpoint is reached, whichever occurs first. The Absorb cycle is called the Constant Voltage Charge Cycle, and because the Absorb voltage is held at a constant value, the current into the batteries will decrease as the batteries fill up. The Absorb cycle commonly commences on most flooded or sealed batteries when the battery is 75% full (+/-).
- **Float** - The Float cycle follows the Absorb cycle. Think of Float as a trickle charger to keep the batteries full and topped off all day. The Barcelona will hold the batteries at the Float voltage setpoint until the Barcelona loses enough sunlight to maintain the Float voltage.
- **Barcelona and Float** - 5 ways the Barcelona comes out of Float:
 - A REBULK voltage setting will force the Barcelona back into Bulk mode if the battery voltage is less than the REBULK setting for 90 seconds. Any “blip” or jump of the battery voltage above the REBULK setting will start the timer back at 90 seconds.
 - Power off the Barcelona for 30 seconds, then turn it back on. It will act like it does at sunup.
 - Start of a new day. New day starts 2-3 hours after the PV voltage drops below 185V.
 - If commanded by another device in the system (i.e., Rosie inverter/charger).
 - Forcing the Barcelona into Float in the User / System Functions menu.
- **Equalize** - Equalization, or EQ, is an elevated voltage maintenance cycle, performed as needed to equalize the internal resistance of the battery cells. During the EQ cycle, the Barcelona applies to the battery bank an elevated charge voltage, which is needed to remove sulfates from the battery’s lead plates. The objective of EQ is to bring all the cells to a near-same level of internal resistance, so that all the cells will take the same charging

EQ Dos & Don’ts

- **Ensure electrolyte solution is near full (Leave room for expansion) before EQ.**
- **Check electrolyte solution after EQ, add distilled water as needed.**
- **During EQ, your inverter may alarm with an over-voltage condition.**



Barcelona Manual

and discharging voltages during normal operation. For the cells to “see” the same voltage amongst the cells promotes battery health and longevity. Confirm with your battery manufacturer if your batteries need EQ or not.

- **Resting** - Not an actual charge stage, Resting means the Barcelona is NOT charging the battery bank for some logic reason, such as not enough sunlight or solar intensity or another charging source is elevating the battery voltage and the Barcelona does not need to contribute any more charging current. The Barcelona will also Rest when the Mode is OFF.
- **Current-Limit** - The Barcelona has a current-limit circuit that interacts with the operating temperature of the unit and/or a user-selectable output current-limit setpoint. When the FET (Field Effect Transistor) temperature reaches 75 C, the Barcelona will reduce its current output on a sliding scale relative to the FET temperature. Or when the current-limit setpoint is reached, the controller will reduce its current output.

DC Input Modes

- **Solar** - This mode is for PV systems and has a fast sweep (typically 1/2 second or less) that will re-sweep at user-adjustable sweep intervals, unless the Barcelona finds that it needs to do a sweep on its own because of changing conditions. The timed sweep interval is user-adjustable and is in units of minutes.

ADVANCED SETTINGS & CONCEPTS

- **Charge Time** - For the Absorb timer, use ... Charge Time = $0.42 \times (\text{Bank Ah} / \text{Charge rate})$.

EXAMPLE:

1. Your battery bank total amp-hour capacity is 400Ah
2. Your charge controller outputs 65A (This is based on PV wattage / nominal bank voltage)
3. Charge Time = $0.42 \times (400 \text{ Ah} / 65\text{A}) = 0.42 \times 6.15 \text{ hours} = 2.6 \text{ hours}$.

For the EQ timer, refer to your battery manufacturer specifications.

- **Temperature Compensation (T-comp)** - There is only one setting in the Barcelona that can influence a different voltage than what you programmed (i.e., Absorb, Float, or EQ) and that is temperature compensation. As a battery gets colder than 25 degrees Celsius, the charging voltage needs to be elevated. As a battery gets warmer than 25C, the charging voltage needs to be lowered. Check with your battery manufacturer and get the following three values:
 1. Millivolts per degree C per cell to compensate (Default is -5mv).
 2. Reference temperature for the battery (Default is 25C).
 3. The maximum voltage to ever compensate to.



Barcelona Manual

Temperature Offset = Number of cells x T-comp setting (Usually -5mv) x offset in degrees Celsius from the reference (Typically 25C).

- **Ending Amps** - Used in conjunction with the MidNite Whiz Bang Jr current-sensing device. Ending amps is set by the battery manufacturer and means the point at which the battery bank is full. During the Absorb charge cycle, the charge controller holds the voltage at the preset charge level, say 58.8V. As the batteries fill up, the current into the batteries decreases. When the decreasing current drops below the preset End Amps point for 90 seconds, the charge controller stops the Absorb cycle and transitions to Float. In the absence of specifications from your battery manufacturer, use 1 – 3% of the total bank amp-hour capacity for ending amps.
- **Re-Bulk** - Forces Barcelona back to the Bulk charge cycle. When the battery voltage drops 1/10V below the Re-bulk setpoint for 90 seconds, the Barcelona then goes back into Bulk Mode.
- **Output Amps** - Limits the Barcelona's output amps. Useful if your system produces more current than the battery manufacturer recommends or if you installed a circuit breaker between the Barcelona and the battery bank that is too small for the current load, and you want to stop nuisance tripping of the breaker.
- **Input Amps** - Limits the incoming amps from the PV array. Usually not needed.
- **Max and Min T-Comp Voltages** – (+/-) 3V offsets above/below charging voltage setpoints.
 - **MAX** – Highest T-comp charging voltage allowed. Adjust if cold battery temp-comp increases battery charging voltage to point that the inverter shuts down from HI BATT. If so, lower the Max T-Comp Voltage so the inverter stays on.
 - **MIN** – Lowest T-comp charging voltage allowed. Leave at default. If the battery is hot enough to make it drop too low, there will be bigger issues to deal with.

BARCELONA PROGRAMMING

The MidNite Graphics Panel 2 (MNGP2) (**Figure 20**) navigates the many menus for programming the Barcelona and displaying data points, historical data points, and system warnings. Below are explanations of the various programmable menu items.

VOICE

- **Audio Mode:**
 - **Off** - No voice.
 - **Rick Mode**
 - **Errors** - All errors such as "Over voltage," "Battery High Temp," etc.



Figure 20



Barcelona Manual

- **Warnings** - All errors and warnings.
- **Verbose** - Menu help messages the first time the menus are accessed. Information messages such as status, charge stage and all warnings and errors.
- **Chatty Cathy** - Menu help messages every time the menus are accessed, all the warnings, errors and status info as described above, plus random hidden messages.
- **Audio Volume:** 1 -10
- **Quiet Time:**
 - **Quiet Time Disable** = Talks 24 hours a day.
 - **Quiet Time Enable** = Has Start Quiet and End Quiet time settings. When activated, Voice will be silenced between the times listed during a 24-hour period.
- **Saving Alert:** OFF/ON
- **Status Interval**
- **Error Interval**

SETUP / BATTERY CONFIG

- **Absorb** – Sets the Absorb charge cycle voltage. This comes from the battery manufacturer. Sometimes called “Bulk,” “Constant Voltage,” or “Boost” charge voltage.
- **Absorb Time** – Amount of time the Barcelona stays in the Absorb charging cycle. Lithium batts usually have no to little Absorb time. Flooded and sealed usually use this formula:

$$(\text{Batt Bank 20hr Ah rating} / \text{Charging Amps}) \times 0.42 = \text{Absorb Time}$$

- **Float** – Sets the Float voltage. Float is like a trickle charger, occurs after the Absorb cycle. Keeps batts full remainder of day.
- **Float Time** – Amount of time Barcelona stays in Float.
- **EQ** – Sets the Equalization (EQ) battery maintenance cycle voltage. Not applicable with Lithium batteries.
- **EQ Time** – Amount of time in EQ. Best to EQ in one-hour cycles, let batts rest, measure the specific gravity of every cell. EQ until the cells are at or less than 0.025 S.G. apart.
- **Rebulk** – Battery voltage setpoint, below Float, that once reached causes the Barcelona to start a new charge cycle ... Bulk – Absorb – Float.
- **Ending Amps** – Amp setpoint at which the batts are fully charge. Commonly 1 – 3% of the bank’s (20-hr) Ah rating. The Barcelona will go to Float when the Absorb Timer counts down to 0 or when Ending Amps is reached, whichever occurs first. Using Ending Amps is a better way to charge the batt bank properly and fully.
- **Battery Capacity** - Enter the bank’s 20-hr, Ah rating. If the bank consists of parallel strings, multiple the 20-hr rating of one battery by the number of parallel strings.



Barcelona Manual

- **Amp Hour Efficiency** – Set to Auto and will consider the Batt Chemistry type selected. Or manually program a specific %. Most Flooded batts start at 80%; Sealed/Gel batts at 95%; Lithium – 94%.
- **Chemistry** - Loads up typical, default charging voltages for the selected chemistry. Useful if the batt specs are unknown. Chemistry selection only available at start-up.
- **Max Charge** - This limits the Barcelona's DC amps to the batt bank. Check the batt specs. If the max charging amps for one batt is 50A, for example, and you have one string of batts, then the max is 50A. If you have two strings, then the max is 100A (2 x 50A).
- **Master Whizbang Jr.** – If using multiple CANBUS-connected MidNite devices, this tells the system which one is connected to the WBJr.
 - **Battery** – Only one WBJr in system monitoring current to/from the battery bank.
 - **Additive** – If more than one WBJr in the system, the SOC% readings are amalgamated.
 - **3rd Party** – Stand-alone current monitoring.
- **Charge Timers** – Count-down timers for Absorb, EQ, and Float; count-up timer for Time-in-Float.
- **Min/Max Temp Comp** – Sets minimum (-3V) and maximum (+3V) offsets above/below the charging voltage setpoints that the Barcelona will not exceed when temperature compensating the batteries. When the batts are cold, T-comp raises the charge (i.e., Absorb) voltage setpoint. The Max Temp Comp setting comes into play here. Conversely, when the batts are warmer than the reference temp, the Barcelona will lower the set charge voltages.
- **EQ Temp Comp** – Turns ON or OFF T-comp during the EQ cycle. Be mindful of an elevated batt bank voltage in the winter when equalizing. This high batt voltage may exceed the DC IN voltage limit on some inverters. Max DC IN for the Barcelona is 65V.
- **Temp Comp mV/Deg C** – This is called the Temp Coefficient Factor. Commonly at -5mV. Check with your batt manufacturer. Set to 0mV for Lithium batts; Lithium does not want T-comp from the Barcelona – the BMS handles T-Comp.
- **Temp Comp Ref** – Commonly 25C, check with the batt manufacturer. This is the neutral or reference temp at which the Rose T-comps around. If batts are colder than the Ref Temp, then the Barcelona will elevate the charge voltage. If warmer, then it will lower the charge voltage.

SETUP / MPPT CONFIG

- **Linked**
- **Mode**
 - **Solar** – Selects operating mode based on DC input type.
 - **Max IN Amps** – Limits input amps.



Barcelona Manual

- **Max OUT Amps** – Limits output amps.
- **Mode ON / OFF** – Controls internal relay to disconnect DC input.
- **AUX Functions**
 - Select desired AUX modes for AUX 1 & AUX 2. See page 29 for AUX modes.
- **Fine Tuning**
 - **Batt Voltage Offset** – Adjustment to correct Batt V sensed by Barcelona.
 - **Debug Display**
 - **Reload EQ Counters**
- **External Sensors**
 - **WBJr**
 - **Disabled**
 - **Battery** – Device connected to WBJr, shared throughout System.
 - **Arc Fault** – Disabled / Enabled
 - **Ground Fault** – Disabled / Enabled
- **Charge Timers** – Displays count-down timers for Absorb and EQ; count-up timer for Float (Time in Float).
- **Data Log**
- **Temperatures** – Displays FET temps and temperature compensated target voltage.
- **Faults and Warnings**
- **Firmware & Serial**
- **Set Name** – Assign custom name to Barcelona.
- **Reset to Defaults** – Performs a factory restore.

USER

- **System Functions**
 - **EQ** – Start / Stop
 - **Force Float** – Force Now
 - **Force Bulk** – Force Now
 - **DC Charge** - Stop / start system charging, global Resting on all charging.
- **Firmware Versions** – Barcelona and MNGP2 Firmware Versions.
- **Serial Numbers** – Barcelona and MNGP2 serial numbers.
- **MNGP2** – Sets display contrast and brightness; backlight timeout; knob sensitivity; shows last fault; Reset Factory Defaults; Bluetooth status; CANBUS statistics.
- **Time & Date** – Set time and date so that data logging is correct.
- **Password** – Password of 1 – 4 – 2 allows setting changes.



Barcelona Manual

AUXILIARY MODES

The Barcelona offers three Auxiliary terminals to be used as a nominal DC trigger voltage source to activate a relay that in turn connects DC accessories (battery vent fan, diversion loads, lights) to the battery bank or an AC relay to break an inverter’s AC output or some other AC source wire. The AUX circuit outputs 10.5VDC at a maximum of 200mA, thus an external relay is required between the accessory and a power source. The AUX circuit will trigger this relay on/off.

The Barcelona has many different AUX modes to choose from based on how you want your accessory turned on or off. The AUX terminal output can be pulse-modulated if that type of varying output is desired. Certain AUX modes allow a start-delay and off-delay timer if it is desired to hold the start function for a period of time, or to prevent the inverse function from occurring for a defined period of time.

Most of the AUX modes have an inverse mode, such as SOC % High and SOC % Low. The “High” of SOC % High infers the AUX terminal is OFF, then turns to ON. The “Low” of SOC % Low infers the AUX terminal is ON, then turns to OFF.

How to read the AUX Mode table below ...

MODE	PWM	ON / OFF	When ON (OFF)?	When OFF (ON)?
SOC % High	Y/N	ON	SOC % (Timer till ON)	SOC % (Timer till OFF)

1. Function is “SOC % High”
2. SOC % High can either be in PWM or no PWM
3. SOC % High is normally OFF and turns to ON
4. To initially turn ON, set the “When ON? SOC %.”
5. To eventually turn OFF, set the “When OFF? SOC %.”
6. To delay when it turns ON, set the timer.
7. To delay when it turns OFF, set the timer.



Barcelona Manual

MODE	PWM	ON / OFF	When ON (OFF)?	When OFF (ON)?
SOC % Low	Y/N	OFF	SOC % (Timer till OFF)	SOC % (Timer till ON)
SOC % High	Y/N	ON	SOC % (Timer till ON)	SOC % (Timer till OFF)
GFP Trip High	Y/N	ON	GFP Fault	(Until fault cleared)
Vent Fan Low	Y/N	OFF	Batt V	0.2V < Batt V
Vent Fan High	Y/N	ON	Batt V	0.2V < Batt V
Float Low	Y/N	OFF	Float	0.3V < Float
Float High	Y/N	ON	Float	0.3V < Float
Day Light	Y/N	ON	(Sunrise)	(Sunset) + XX Time
Nite Light	Y/N	ON	(Sunset)	(Sunrise) + XX Time
Toggle Test	Y/N	ON	(Manual ON)	(Manual OFF)
PV V on Low	Y/N	OFF	PV V (Timer till OFF)	PV V (Timer till ON)
PV V on High	Y/N	ON	PV V (Timer till ON)	PV V (Timer till OFF)
Waste Not Low	Y/N	OFF	-X.X V (Timer till OFF)	-X.X V (Timer till ON)
Waste Not High	Y/N	ON	-X.X V (Timer till ON)	-X.X V (Timer till OFF)
Batt V Disc Low	Y/N	OFF	Batt V (Timer till OFF)	Batt V (Timer till ON)
Batt V Disc High	Y/N	ON	Batt V (Timer till ON)	Batt V (Timer till OFF)
Auto Gen Start	N/A			
Gen ON Volts		ON	Batt V	Batt V
Gen Start Delay			(In minutes)	
Min Gen Run			(In minutes)	
Max Gen Run			(In minutes)	
Gen Run Confirm			(In Volts)	
Batt Temp High	Y/N	ON	XX F/C	XX F/C
Batt Temp Low	Y/N	OFF	XX F/C	XX F/C
PCB Temp	Y/N	ON	XX F/C	XX F/C
FET Temp	Y/N	ON	XX F/C	XX F/C



Barcelona Manual

FIRMWARE UPDATE

1. Download to your cell phone the Barcelona firmware (FW) from the MidNite Solar website using this link ...
<https://www.midnitesolar.com/firmwareIndex.php>
2. Install the FW on your phone.
3. Energize the Barcelona by closing the battery breaker.
4. FW app will appear as shown in **Figure 21**.
5. Tap the label that reads MNGP2.
6. The FW app will connect to the Barcelona, then the app will appear as shown in **Figure 22**.
7. Tap the box that reads MNGP2 Standard.
8. FW app will appear as shown in **Figure 23**, select OK.
9. FW app will show transfer progress, **Figure 24**.
10. FW app will indicate when done, **Figure 25**. Select OK.
11. Repeat to load Barcelona FW.

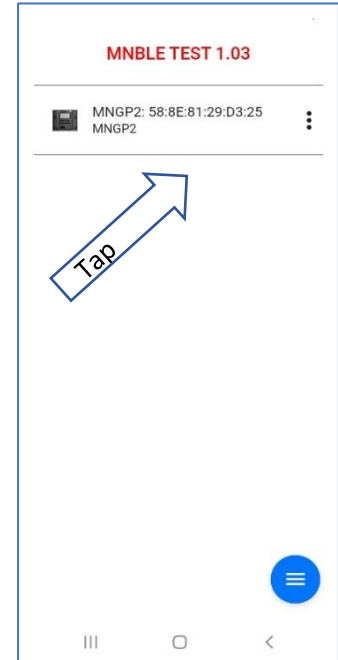

Figure 21

WARNING!

Firmware updates require Internet access AT the device.

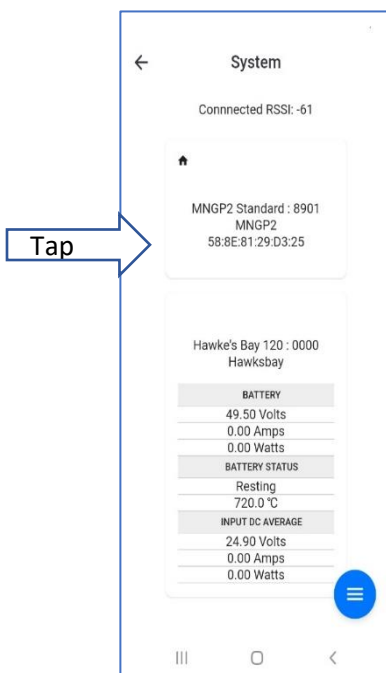

Figure 22

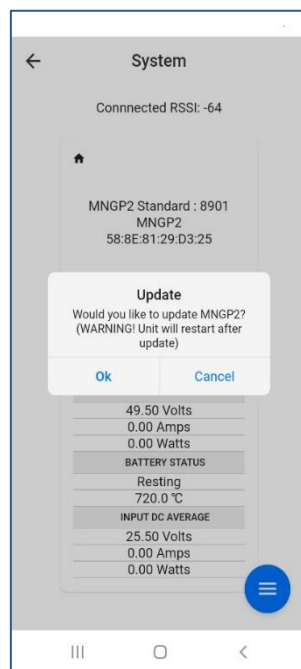

Figure 23

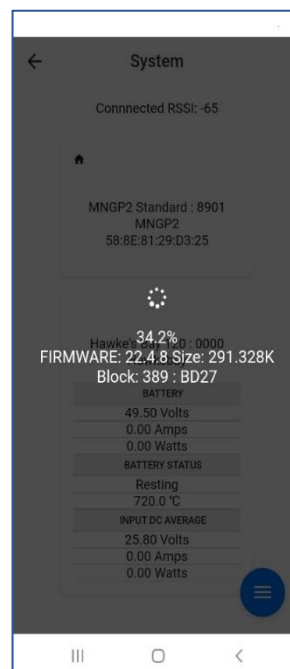

Figure 24

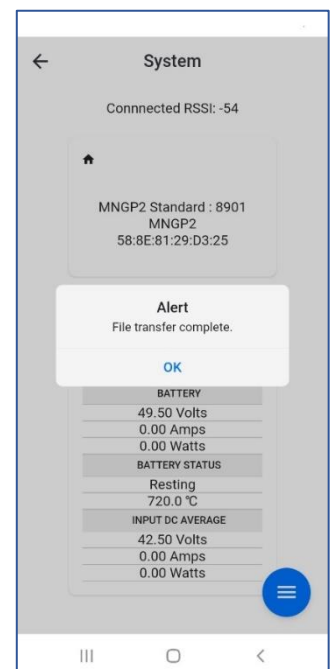

Figure 25



Barcelona Manual

TROUBLESHOOTING

No Power Out - Resting

Resting means the Barcelona is not in Bulk, Absorb, Float, or Equalization charging modes. If the PV input is absent or the PV voltage is too low, the Barcelona will remain in Resting. Check that the Mode is ON. If the Mode is OFF, the MNGP2 will display “Mode is OFF” vice “RESTING,” but the Barcelona will act like it is Resting. Is it overcast outside? PV panels need sunlight intensity (photons) to create PV current. No current = Resting.

Daylight creates PV voltage; sunlight intensity creates PV current.

PV voltage x PV current = PV wattage.

A poor connection in the PV source circuit may generate a high resistance, which leads to heat build-up, which reduces or “drops” the voltage, which increases the current flow. All of this is bad! Check your connections.

PV Input Issue

If the PV input voltage drops too low or is absent, the problem probably lies in the PV source circuit; that is, the wiring, disconnects, and circuit breaker(s) on the PV side of the charge controller.

Low or no PV Voltage:

- Defective PV module:
 - Bad internal solder joint between cells.
 - Defective internal bypass diodes.
 - Defective module PV connectors.
- Defective installation of PV connectors:
 - Poor crimping of the terminal.
 - PV connector not plugged in all the way.
- A wire shorting out intermittently:
 - Pinched wire that might be shorting out when the aluminum module frame expands and contracts.
 - A wire that has been moving with the wind and rubbed through the insulation.
- PV input circuit breaker:
 - Loose wire connection into the PV input circuit breaker.



Barcelona Manual

- Using a circuit breaker NOT rated for DC current.
- Defective components inside the circuit breaker.
- Loose crimp/screw/lug of the wire connected to the circuit breaker.

Connecting or disconnecting PV connectors (MC4) while the module is in the sun MAY damage the connector contacts.

Low PV Voltage

As explained earlier, the Barcelona needs the PV Voc input to be at least 240V to perform MPPT operations. If the Voc is lower than that, the Barcelona may rest.

How are your panels wired? If all the panels in your array are wired in parallel, the Barcelona sees the voltage of a single panel. In a parallel configuration the Barcelona will rest.

Solution – Wire the panels in series, but not to exceed the Barcelona’s voltage input of 600V. The Barcelona needs a minimum Voc of 240V.

Is the IN voltage 0 on the MNGP2? If yes, check for reverse polarity on the PV input.

Battery Over-voltage

Ensure the battery voltage is below the Absorb and Float voltage setpoints. If not, do you have another charging source (2nd solar, wind, inverter-charger) on your battery bank? If so, turn it off until you finish troubleshooting the Barcelona.

Disappearing PV IN Voltage

Disconnect the PV wires from the Barcelona’s input terminal block. Using a multimeter, measure the PV voltage directly from the PV wires. Is voltage present? If not, see PV INPUT ISSUE section above. If voltage is present, reconnect the PV wires to the Barcelona’s terminal block. Be mindful of polarity and always turn off circuit breakers before connecting or disconnecting any wires. With the PV wires connected, does the IN voltage drop to zero or near zero volts? If so, check for a high resistance connection or the Barcelona may be defective.

Bulk-to-Resting

Is your Barcelona switching between Bulk and Resting? This means the Barcelona is trying to make power, has sufficient PV input voltage, goes into the Bulk charging mode, then very quickly switches to Resting.

- If PV IN voltage drops to battery voltage or close to it, the problem is probably a bad PV connection.
- If PV IN voltage remains the same or at a normal level, the Barcelona has probably lost its FET drive.



Barcelona Manual

NOTE: With the PV wires disconnected from the Barcelona or the PV input circuit breaker turned off, does the MNGP2 show some IN voltage? If yes, this is a good thing. If you see 0V, that is a bad thing. The Barcelona needs repair.

Will Not Turn On

- Check Barcelona battery circuit breaker.
- Check for reverse polarity of battery positive and negative connections to the Barcelona.
- Battery voltage needs to be **29V** or higher for the Barcelona to power up. If less than **29V**, charge the battery bank using external source of power.

Ground Fault

Ground Fault means one of the current-carrying conductors (positive or negative) is in contact with earth ground. If a ground fault is detected, the Barcelona will cease power production and alarm. The GF condition must be fixed and the Barcelona power-cycled off then on to clear the alarm.

To test the Barcelona's GFP feature – Remove the PV- wire from the Barcelona, route PV- outside the GF toroid, then reconnect PV- to the PV- terminal in the Barcelona. The measured differential PV current will cause a GF alert.

Arc Fault

An arc fault is a short which produces an electrical spark (arc). An arc fault may occur on the PV source circuit or even on the battery side of the Barcelona. No AF testing is required.

Over-Current Protection ... Reasons for OCP activation:

- Bad or weak battery; bad/faulty/loose/corroded wire connection.
- Barcelona sharing the inverter battery cables. (Barcelona connected to battery bus bars near the inverter).
- DC cables for the inverter or Barcelona are too small. This can cause surges in the inverter and an attempt to pull too much current from the Barcelona.

Device Reset

Resets all settings to factory defaults and clears any processor logic issues:

1. Write down any custom settings for reference prior to resetting the Barcelona.
2. Go to the MPPT Menu.
3. Go to Reset to Defaults.
4. Highlight Reset to Defaults, depress round knob.

ALWAYS turn the battery power on first to the Barcelona, then the PV input.

0.199 x 2.36

0.20 X 1.1

MNBLNA

BARCELONA MPPT
OPERATING RANGE -40°C TO 50°C
MAX PV VOLTAGE (OPERATING) 550VDC
MAX PV VOC 600VDC
MIN TRACKING VOLTAGE 185 VDC
MAX TRACKING VOLTAGE 550VDC
MAX BATTERY CHARGE VOLTAGE 65V
NOMINAL BAT VOLTAGE 48VDC
MAX PV CURRENT(OPERATING) 36A
MAX PV SHORT CIRCUIT CURRENT 40A
MAX BATTERY CHARGE CURRENT 200A
MAX OUTPUT FAULT CURRENT 200 AMPS
MAX OUTPUT PER MPPT SIDE 100 AMPS

WARNING: DC INPUT NOT ISOLATED FROM BATTERY CIRCUIT.

CAUTION: RISK OF ELECTRIC SHOCK - MORE THAN ONE DISCONNECT SWITCH MAY BE REQUIRED TO DE-ENERGIZE THE EQUIPMENT BEFORE SERVICING.

CAUTION: BONDING BETWEEN CONDUIT CONNECTION IS NOT AUTOMATIC AND MUST BE PROVIDED AS PART OF THE INSTALLATION. USE ONLY WITH COPPER CONDUCTORS RATED 90°C MIN.

ATTENTION:
L'INTERCONNEXION DES CONDUITS NE SUFFIT PAS POUR ASSURER LA MISE A LA MASSE; ELLE DOIT FAIRE PARTIE INTEGRANTE DE L'INSTALLATION.
UTILISER UNIQUEMENT AVEC CONDUCTEURS DE CUIVRE NOMINALE MINIMALE DE 90° C.

AVERTISSEMENT:
CET EQUIPEMENT REPERME PLUSIEURS CIRCUITS SOUS TENSION. VOIR LE SCHEMA.
THIS EQUIPMENT IS CAPABLE OF ADDING NEC 2020 COMPLIANT GROUND FAULT OPTIONS.
PART NUMBER MNHBS-AFGF KIT.
THIS EQUIPMENT IS CAPABLE OF ADDING ARC FAULT LISTED TO UL1741. USE PART NUMBER MNHBS-AFGF KIT.
THIS EQUIPMENT IS CAPABLE OF ADDING NEC COMPLIANT RAPID SHUTDOWN. USE PART NUMBER MNHBS-RSD KIT.

LARGE LUGS (BATTERY)
2/0 - 8 AWG 20 IN-18.5 (2.8 Nm)

TORQUE SMALL LUGS (PV)
4- 6 AWG 3.5 IN-1.85 (4 Nm)
8 AWG 2.5 IN-1.85 (2.8 Nm)
10- 14 AWG 2.0 IN-1.85 (2.3 Nm)

GROUND LUG TO RQUE
4- 6 AWG 3.5 IN-1.85 (4 Nm)
8 AWG 2.5 IN-1.85 (2.8 Nm)
10- 14 AWG 2.0 IN-1.85 (2.3 Nm)

3084883

IF OPTION INSTALLED:
ARC FAULT UL1699B
GROUND FAULT MPPA 70
RAPID SHUTDOWN 695.12

Inverters, Converters, Controllers and Interconnection System Equipment for use with Distributed Energy Resources
Conforms to: 50 (UL 1741) 2019 (UL-1699B) 2018
Power Connection Equipment
Certified to: 50 (CSA C22.2) 1807.1-2018 (UL4)

3084883

3084883

IF OPTION INSTALLED:
ARC FAULT UL1699B
GROUND FAULT MPPA 70
RAPID SHUTDOWN 695.12

Inverters, Converters, Controllers and Interconnection System Equipment for use with Distributed Energy Resources
Conforms to: 50 (UL 1741) 2019 (UL-1699B) 2018
Power Connection Equipment
Certified to: 50 (CSA C22.2) 1807.1-2018 (UL4)

3084883

SEE MANUAL FOR ADDITIONAL INFORMATION ABOUT ARC FAULT, GROUND FAULT, AND RAPID SHUTDOWN OPTIONS

DESIGNED AND ASSEMBLED IN THE USA WITH DOMESTIC AND FOREIGN COMPONENTS

19115 62nd Ave NE
Arlington, Wa
98223 USA

MANUFACTURE DATE

Q1	Q2	Q3	Q4
22	23	24	25
26	27	28	29

www.midnitesolar.com

TYPE OF PANEL 1741

10-419-1 REV F

10-419-1 REV F

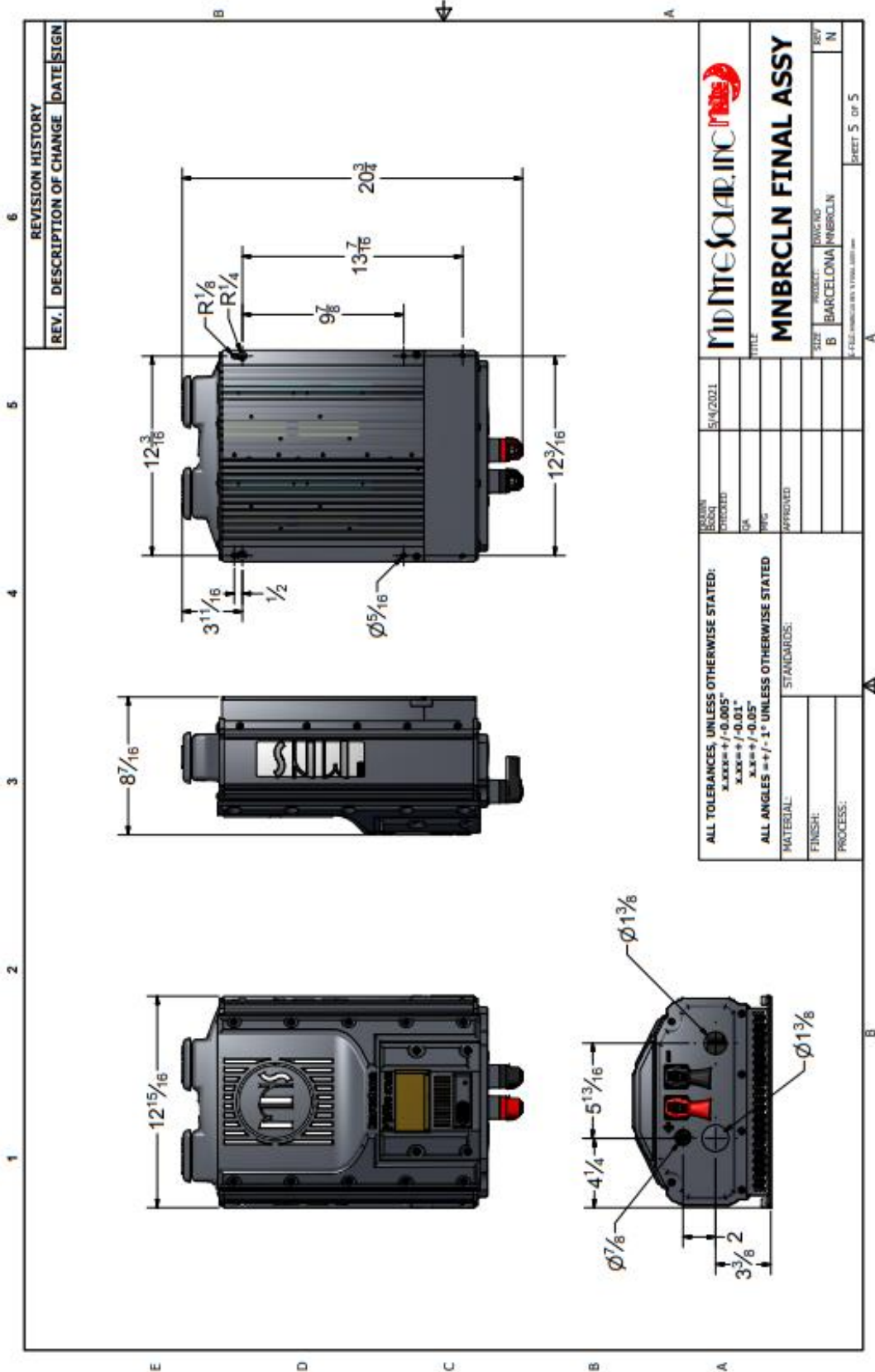

14-001-1

REV.	DESCRIPTION OF CHANGE	DATE	SIGN

ITEM	QTY	PART NUMBER	DESCRIPTION
1	1	3-910-1	BARCELONA PAN SPRING
2	1	5-571-1	BARCELONA DC END BOTTOM TRAY
3	8	6-006-1	10-34X17.5 SILVER SS
4	8	6-173-1	6-173-1 10-34X17.5 (W/SH)
5	8	6-173-1	SOCKET SS 6-32 X 1.25 PTP SS

<p>ALL TOLERANCES, UNLESS OTHERWISE STATED: X.XXX = +/- 0.005" X.XX = +/- 0.01" X.X = +/- 0.05"</p> <p>ALL ANGLES = +/- 1° UNLESS OTHERWISE STATED</p> <p>MATERIAL: _____ STANDARDS: _____</p> <p>FINISH: _____</p> <p>PROCESS: _____</p>	<p>DATE: 12/24/2020</p> <p>DESIGN: APPROVED</p> <p>QA: _____</p> <p>WFG: _____</p> <p>APPROVED: _____</p>
--	---

MIDNITE SOLAR, INC.	
MNBCLNA FINAL ASSY	
DATE: B	PROJECT: BARCELONA
REV: L	PROJECT: BARCELONA
SHEET 2 OF 5	

REV.	DESCRIPTION OF CHANGE	DATE	SIGN

14-002-1

ITEM NO	PART NUMBER	DESCRIPTION
31	3-807-1	BARCELONA AIR EXH. END
37	3-964-1	BARCELONA FAN INLET SHROUDD
79	3-965-1	BARCELONA AIR INLET MESH
78	6-388-2	SCREW 6-32 X 2.8 PH P/BK ZN
78	6-470-1	SCREW 6-32 X 1.25 PH P/BK ZN
75	9-1384-1	FAN 12V SURVON KDE1208P1V3

ALL TOLERANCES, UNLESS OTHERWISE STATED:
X.XXXXX +/- 0.005"
X.XX +/- 0.01"
X.X +/- 0.05"

ALL ANGLES = +/- 1° UNLESS OTHERWISE STATED

MATERIAL: _____
FINISH: _____
PROCESS: _____

STANDARDS: _____

MNBLNA FINAL ASSY

DATE: 12/24/2020

APPROVED: _____

DESIGNED BY: _____

SIZE: B

REV: L

SHEET 3 OF 5

14-003-1

REV.	DESCRIPTION OF CHANGE	DATE	SIGN

Exploded view diagram of the MNBCLN Final Assy. The main component is a large black plastic housing (part 5-544-1). Other parts shown include: 6-027-1 (screws), 6-189-1 (nuts), 3-817-1 (washers), 3-909-1 (bracket), 6-406-1 (bracket), 6-300-1, 6X (bracket), 3-946-1 (bracket), 5-544-2 (bracket), 6-188-1 (bracket), 6-404-1 (bracket), 6-405-1 (bracket), 3-946-1 (bracket), 6-406-1 (bracket), 6-188-1 (bracket), 6-404-1 (bracket), 6-405-1 (bracket), 3-946-1 (bracket), 6-406-1 (bracket), 6-188-1 (bracket), 6-404-1 (bracket), 6-405-1 (bracket).

ITEM	QTY	PART NUMBER	DESCRIPTION
75	1	3-817-1	BARCELONA NEG BATTERY TERMINAL BUSHING
76	1	3-909-1	BARCELONA POS BATTERY TERMINAL BUSHING
77	1	3-946-1	BARCELONA BATTERY END BATTERY TERMINAL BUSHBAR
78	2	3-946-1	BARCELONA BATTERY END BATTERY TERMINAL BUSHBAR
79	2	3-946-1	BARCELONA BATTERY END BATTERY TERMINAL BUSHBAR
80	1	5-544-2	BARCELONA RED BATTERY INSULATOR
81	1	5-544-2	BARCELONA BLACK BATTERY INSULATOR
82	2	6-027-1	5-16 KEPS NUT SSS
83	2	6-188-1	HEX BOLT 5-16 X 75 SSS
84	2	6-188-1	HEX BOLT 5-16 X 75 SSS
85	2	6-188-1	HEX BOLT 5-16 X 75 SSS
86	2	6-188-1	HEX BOLT 5-16 X 75 SSS
87	2	6-188-1	HEX BOLT 5-16 X 75 SSS
88	2	6-188-1	HEX BOLT 5-16 X 75 SSS
89	2	6-188-1	HEX BOLT 5-16 X 75 SSS
90	2	6-188-1	HEX BOLT 5-16 X 75 SSS
91	2	6-188-1	HEX BOLT 5-16 X 75 SSS
92	2	6-188-1	HEX BOLT 5-16 X 75 SSS
93	2	6-188-1	HEX BOLT 5-16 X 75 SSS
94	2	6-188-1	HEX BOLT 5-16 X 75 SSS
95	2	6-188-1	HEX BOLT 5-16 X 75 SSS
96	2	6-188-1	HEX BOLT 5-16 X 75 SSS
97	2	6-188-1	HEX BOLT 5-16 X 75 SSS
98	2	6-188-1	HEX BOLT 5-16 X 75 SSS
99	2	6-188-1	HEX BOLT 5-16 X 75 SSS
100	2	6-188-1	HEX BOLT 5-16 X 75 SSS

ALL TOLERANCES, UNLESS OTHERWISE STATED:
 X.XXX = +/- 0.005"
 X.XX = +/- 0.01"
 X.X = +/- 0.05"
ALL ANGLES = +/- 1° UNLESS OTHERWISE STATED

MATERIAL: _____
 FINISH: _____
 PROCESS: _____

STANDARDS: _____

DATE: 12/24/2020

CHECKED: QA

APPROVED: _____

MIDNITE SOLAR, INC.

MNBCLN FINAL ASSY

SIZE: B
 PROJECT: BARCELONA
 DRAWING: MNBCLN
 REV: L

FIG. 24 OF 24
 SHEET 4 OF 5



Barcelona Manual

MIDNITE SOLAR INC. LIMITED WARRANTY

MidNite Solar Power electronics, sheet metal enclosures and accessories

MidNite Solar Inc. warrants to the original customer that its products shall be free from defects in materials and workmanship. This warranty will be valid for a period of five (5) years.

MidNite Solar will not warranty third party inverter components used in MidNite's pre-wired systems. Those components are warranted by the original manufacturer.

At its option, MidNite Solar will repair or replace at no charge any MidNite product that proves to be defective within such warranty period. This warranty shall not apply if the MidNite Solar product has been damaged by unreasonable use, accident, negligence, service, or modification by anyone other than MidNite Solar, or by any other causes unrelated to materials and workmanship. The original consumer purchaser must retain original purchase receipt for proof of purchase as a condition precedent to warranty coverage. To receive in-warranty service, the defective product must be received no later than two (2) weeks after the end of the warranty period. The product must be accompanied by proof of purchase and Return Authorization (RA) number issued by MidNite Solar. For an RMA number contact MidNite Solar Inc., (360) 403-7207. Purchasers must prepay all delivery costs or shipping charges to return any defective MidNite Solar product under this warranty policy. Except for the warranty that the products are made in accordance with, the specifications therefore supplied or agreed to by customer:

MIDNITE SOLAR MAKES NO WARRANTY EXPRESSED OR IMPLIED, AND ANY IMPLIED WARRANTY OF MERCHANTABILITY OR FITNESS FOR A PARTICULAR PURPOSE WHICH EXCEEDS THE FOREGOING WARRANTY IS HEREBY DISCLAIMED BY MIDNITE SOLAR AND EXCLUDED FROM ANY AGREEMENT MADE BY ACCEPTANCE OF ANY ORDER PURSUANT TO THIS QUOTATION. MIDNITE SOLAR WILL NOT BE LIABLE FOR ANY CONSEQUENTIAL DAMAGES, LOSS OR EXPENSE ARISING IN CONNECTION WITH THE USE OF OR THE INABILITY TO USE ITS GOODS FOR ANY PURPOSE WHATSOEVER. MIDNITE SOLAR'S MAXIMUM LIABILITY SHALL NOT IN ANY CASE EXCEED THE CONTRACT PRICE FOR THE GOODS CLAIMED TO BE DEFECTIVE OR UNSUITABLE.

Products will be considered accepted by customer unless written notice to the contrary is given to MidNite Solar within ten (10) days of such delivery to customer. MIDNITE SOLAR is not responsible for loss or damage to products owned by customer and located on MIDNITE SOLAR'S premises caused by fire or other casualties beyond MIDNITE SOLAR'S control. This warranty is in lieu of all other warranties expressed or implied.

MIDNITE SOLAR INC.

NOTICE OF COPYRIGHT

MidNite Solar's Barcelona Charge Controller Owner's Manual.
Copyright © 2022 All rights reserved.

MidNite Solar, Inc. reserves the right to revise this document and to periodically make changes to the content hereof without obligation or organization of such revisions or changes unless required to do so by prior arrangement.



Barcelona Manual

DISCLAIMER

Unless specifically agreed to in writing, MidNite Solar Inc.: (a) Makes no warranty as to the accuracy, sufficiency, or suitability of any technical or other information provided in its manuals or other documentation; (b) Assumes no responsibility or liability for loss or damage whether direct, indirect, consequential, or incidental, which might arise out of use of such information. The use of any such information will be entirely at the user's risk.

CONTACT

360.403.7207

customerservice@midnitesolar.com

www.midnitesolar.com





Barcelona Manual

PV Voltage Correction Factors

Ambient Temp / C	Factor	Ambient Temp / F
24 to 20	1.02	76 to 68
19 to 15	1.04	67 to 59
14 to 10	1.06	58 to 50
9 to 5	1.08	49 to 41
4 to 0	1.10	40 to 32
-1 to -5	1.12	31 to 23
-6 to -10	1.14	22 to 14
-11 to -15	1.16	13 to 5
-16 to -20	1.18	4 to -4
-21 to -25	1.20	-5 to -13
-26 to -30	1.21	-14 to -22
-31 to -35	1.23	-23 to -31
-36 to -40	1.25	-32 to -40