

THMS5000

5000WATT / 10000WATT PEAK

POWERS UP TO 50AMPS



THE CHOICE FOR PERFORMANCE

THMS5000



MODIFIED SINE WAVE INVERTER









THOR inverters have set the standard with the way you deal with your mobile power needs, providing AC electricity. A power inverter converts the DC electricity from batteries into everyday AC power.

With a THOR inverter you won't need to rely on a generator to have power for tools, electronics or any AC power needs. THOR inverters are efficient and dependable and come in numerous sizes and power ranges to meet your mobile power demands.

Design Features

- 5000 Watts Continuous Output
- 10000 Watt High Surge Power
- 4 x GFCI Protected 120 Volt AC Outlets
- Compatible with all THOR Remote Controls
- USB Charging Port
- Rugged Aluminum Design
- Compatible with Appliances <= 5000 watts
- Digital Display
- Easy Installation

Accessories

 TH-002	 TH-RC	 TH-IRC
Remote Controls		
 Cables (4/0 - 10 Feet) THCBL10F4/0	 Fuses THANLFB500 500 Amp Fuse	 Isolators THI-500 500 Amp Isolator
 AC Extension TH-EXT	 Low Voltage Disconnect TH-LVD	 Transfer Switch THTS50

5000 WATT MODIFIED SINE WAVE INVERTER WITH USB

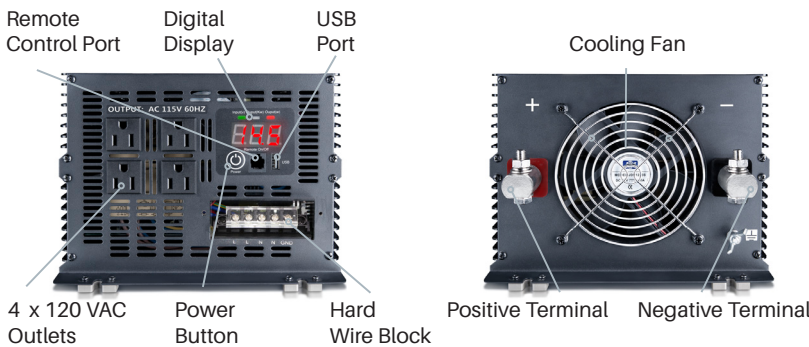

Specifications

DC Input Voltage	12 Vdc
DC Input Voltage range	10.5 - 16.5 +/- .5
Maximum Output Current	50 Amps
Continuous Output Power	5000 Watts
Max Output for 10 Min - 10% over inverters rated continuous wattage	n/a
Surge Output Power	10000 Watts
Peak Efficiency	85-90%
DC Input Connections	Bolt Down Lugs
AC Output Connection	4 x GFCI Protected 120 Volt AC outlets
Terminal Block for Hardwiring	Yes
Display	Digital Display With Error Codes



THOR MANUFACTURING

7050 W. Palmetto Park Rd. Suite 15
 Boca Raton, FL

Phone: (866) 955-THOR
 (866) 955-8467

Mail: sales@thorpowerproducts.com
 Web: www.thorinverters.com

Dimensions

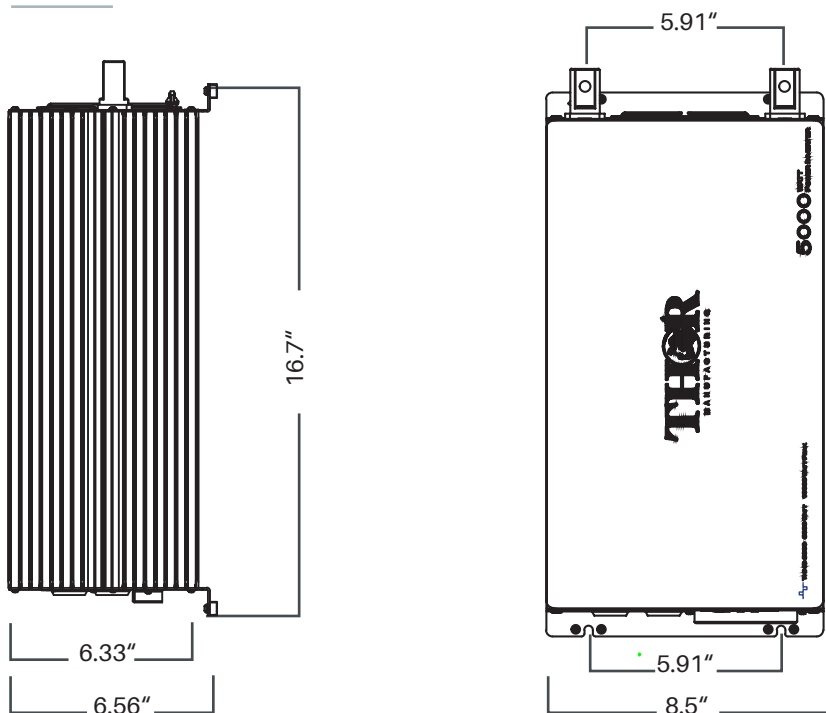

Dimensions: 17.7L x 8.5W x 6.62\"H
 Weight: 25 Lbs
 UPC Code: 853003006636
 Warranty: 1 Year

Installation Diagrams

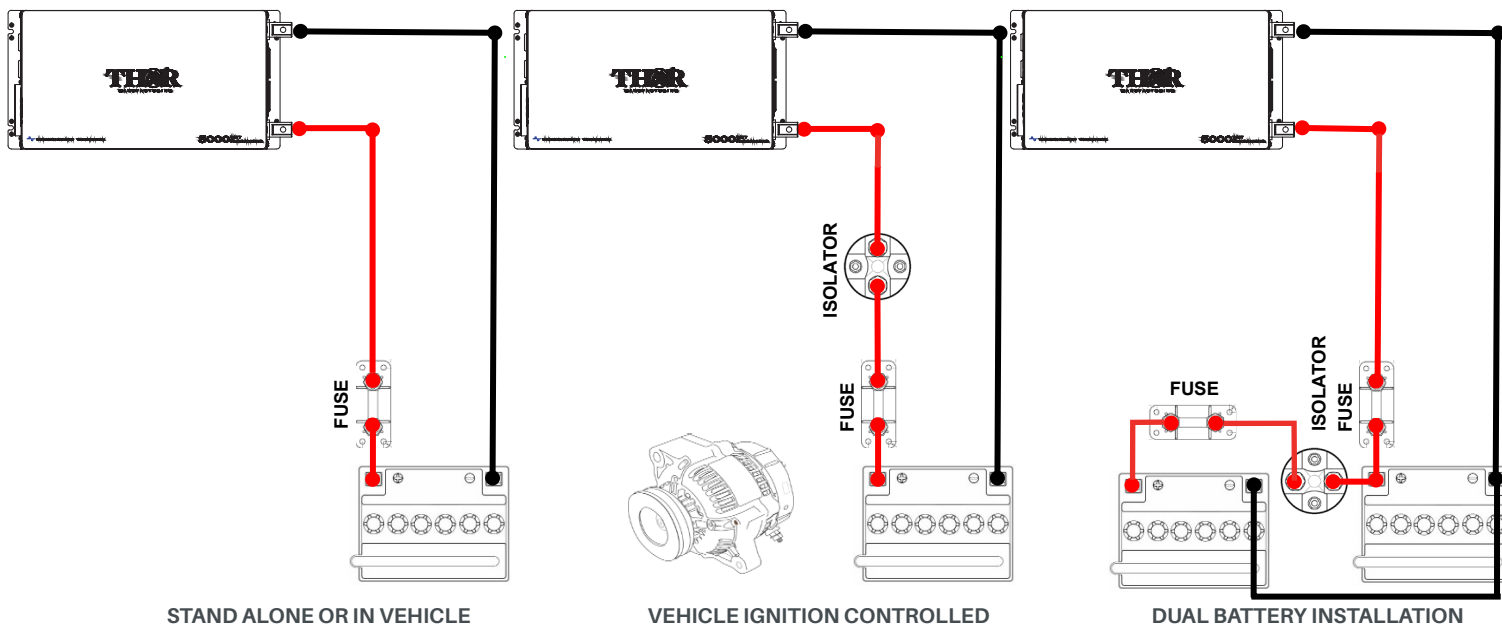

Inverters are also available as Installation Kits (including the inverter)

THMS5000-KIT 2

THMS5000-KIT 3

THMS5000-PRO KIT

THMS5000-RV KIT



THOR MANUFACTURING
 7050 W. Palmetto Park Rd. Suite 15
 Boca Raton, FL

Phone: (866) 955-THOR
 (866) 955-8467

Mail: sales@thorpowerproducts.com
 Web: www.thorinverters.com