





Module Introduction

51.2V200AH 10240WH



-  **All-time monitor**
-  **Safety for home**
-  **Long Lifespan**
-  **Flexible capacity**
-  **Easy Installation**

Normal	
Model	BR4820016
Battery Type	LifePO4(LFP)
Nominal Voltage(V)	51.2V
Nominal Capacity(WH)	10240WH
Usable Capacity(WH)	8192WH
Design Life	10+ Years (25°C/77F)
Physical	
Dimension(mm)	480*422*400
Weight(kg)	110
Electrical	
Cycle Life	>6000, 25°C
Discharge Voltage(V)	40~58.4
Charge Voltage(V)	56~58.4
Charge/Discharge Current(A)	60A(Recommended)
	100A(Max)
Internal Resistance	≤30mΩ
BMS	
Power Consumption	<2W (Work)
	<100mW(Sleep)
Monitoring Parameters	System voltage, Current, cell voltage, cell temperature, module temperature
SOC	Intelligent algorithm
Communication	CAN/RS-485
Operation	
Operating Temperature Range	-10°C~50°C
Transport or Storage Temperature Range	-20°C~45°C
Humidity	15%~85% (No Condensing)

1. Specification

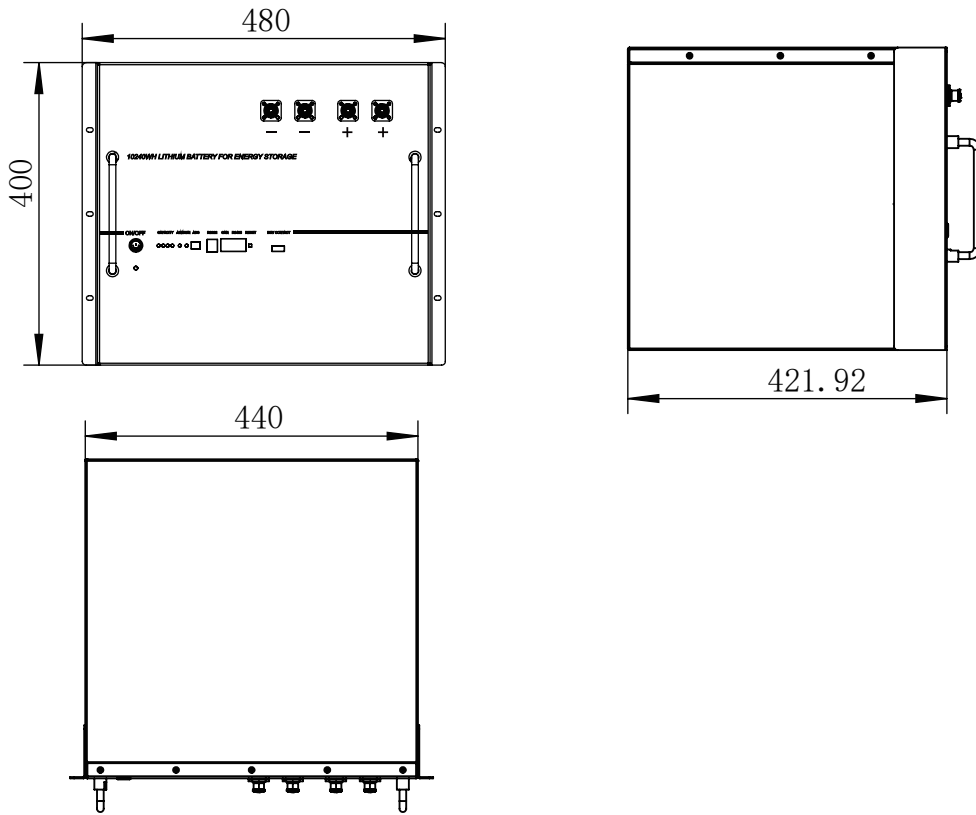

2. Equipment Interface Instruction

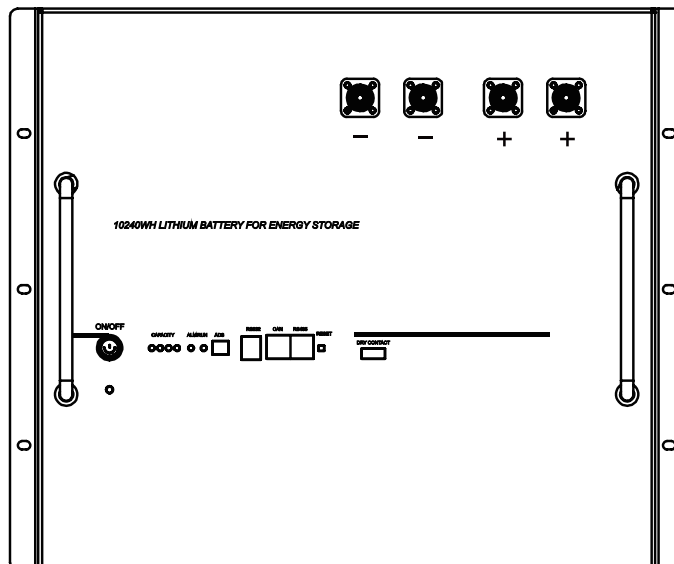

POWER SWITCH

Power Switch: to turn ON/OFF the whole battery BMS standby, power output ready.

SOC

SOC light: green LEDs to show the battery's current capacity.

RUN

RUN light: green LED flashing to show the battery is running.

ALM

Alarm light: red LED flashing to show the battery has alarm, and lighting to show the battery is under protection.

LED INDICATORS INSTRUCTIONS

State	Normal/Warning/Protection	RUN	ALM	Power indicator LED				Instruction
		●	●	●	●	●	●	
Shut down	Dormancy	OFF	OFF	OFF	OFF	OFF	OFF	All OFF
Standby	Normal	Flash 1	OFF	Follow module capacity				Standby
	Warning	Flash 1	Flash 3					Module at low voltage
Charge	Normal	ON	OFF	Follow module capacity				LED flash2 at full capacity,ALM doesn't flash at overcharge warning
	Warning	ON	Flash 3	(Flash 2 at full capacity)				
	Overcharge protection	ON	OFF	ON	ON	ON	ON	if no grid supply, LED turn to standby.
	Temperature,overcurrent,disabled protection	OFF	ON	OFF	OFF	OFF	OFF	Stop charging
Discharge	Normal	Flash 3	OFF	Follow module capacity				
	Warning	Flash 3	Flash 3					
	Under voltage protection	OFF	OFF	OFF	OFF	OFF	OFF	Stop discharging
	Temperature,overcurrent, short circuit, reverse connect, disabled protection	OFF	OFF	OFF	OFF	OFF	OFF	Stop discharging
Disabled		OFF	OFF	OFF	OFF	OFF	OFF	Stop charging and discharge

NOTE: The flashing instructions, flash1 - light 0.25s / off 3.75 seconds; flash 2 - 0.5s light / 0.5s off;flash 3 - 0.5s light / 1.5s off

RS232

RS232 Communication Terminal: (RJ11 port) follow RS232 protocol, for output batteries information.

CAN

CAN Communication Terminal: (RJ45 port) follow CAN protocol, for output batteries information.

RS485

RS485 Communication Terminal: (RJ45 port) follow RS485 protocol, for communication between multiple parallel batteries.

Definition of RJ45 Port Pin

NO	RJ45 PIN
1、 8	RS485-B
2、 7	RS485-A
3、 6	GND
4	CAN-H
5	CAN-L

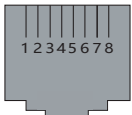

Definition of RJ11 Port Pin

NO	RJ45 PIN
1、 2、 6	NC
3	TX (Single face)
4	RX (Single face)
5	GND

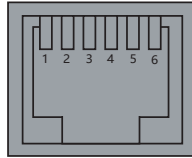

ADD

	Dial code switch position				Instruction
	#1	#2	#3	#4	
0	OFF	OFF	OFF	OFF	No cascade, use single
1	ON	OFF	OFF	OFF	Set to Pack1(Host)
2	OFF	ON	OFF	OFF	Set to Pack2
3	ON	ON	OFF	OFF	Set to Pack3
4	OFF	OFF	ON	OFF	Set to Pack4
5	ON	OFF	ON	OFF	Set to Pack5
6	OFF	ON	ON	OFF	Set to Pack6
7	ON	ON	ON	OFF	Set to Pack7
8	OFF	OFF	OFF	ON	Set to Pack8
9	ON	OFF	OFF	ON	Set to Pack9
10	OFF	ON	OFF	ON	Set to Pack10
11	ON	ON	OFF	ON	Set to Pack11
12	OFF	OFF	ON	ON	Set to Pack12
13	ON	OFF	ON	ON	Set to Pack13
14	OFF	ON	ON	ON	Set to Pack14
15	ON	ON	ON	ON	Set to Pack15



RESET

RESET: Press more than 3 seconds to restart battery module.

DRY CONTACT

Dry Contact Terminal: provided 1 way input and 1 way output dry contact signal.

POWER TERMINAL

Power cable terminals: there are two pair of terminals with same function, one connect equipment, the other one paralleling to other battery module for capacity expanding. For each single module, each terminal can achieve charging and discharging function. For power cables uses water-proofed AMPHENOL connectors. It must keep pressing this Lock Button during pulling out the power plug..

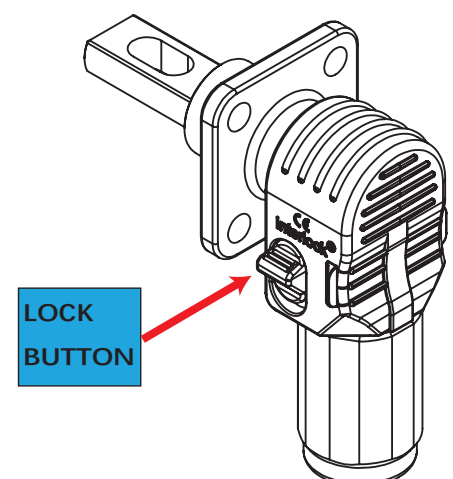

3. BMS Function

Protection and Alarm	Management and Monitor
Charge/Discharge	Cells Balance
Charge Over Voltage	Intelligent Charge Model
Charge/Discharge Over Current	Charge/Discharge Current Limit
High/Low Temperature	Capacity Retention Calculate
Short Circuit	Administrator Monitor
Power Cable Reverse	Operation Record

4. Schematic Diagram of Solution

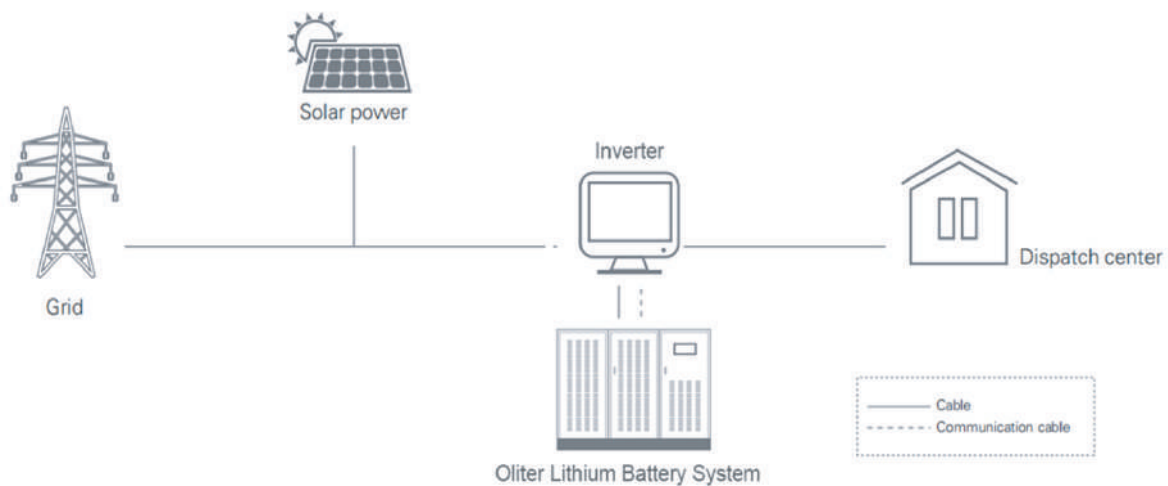

5. Package Items

5.1 For battery module package:

Two power cables and one communication cable for each battery package:

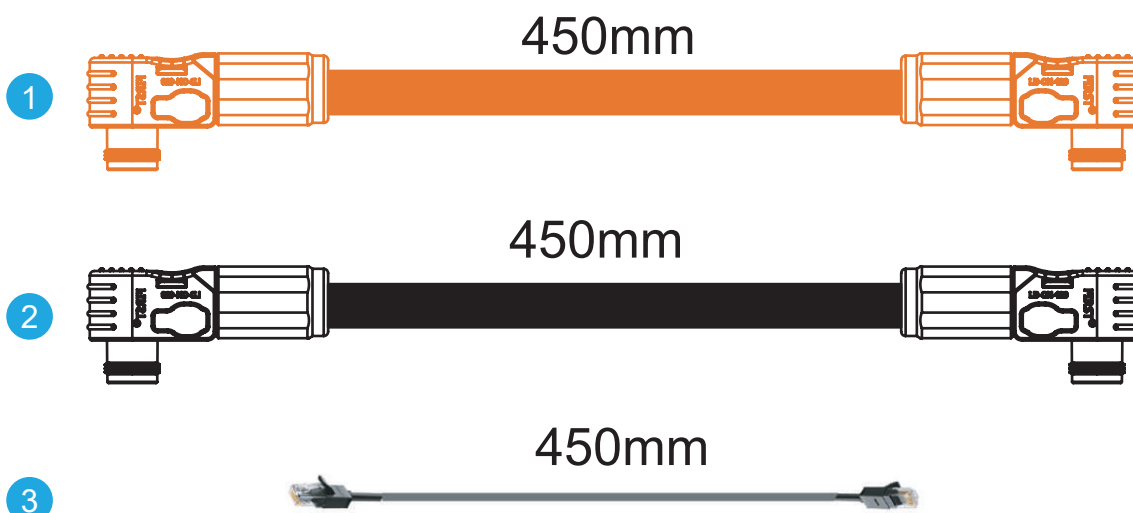

5.2 For battery system connects to inverter:

Two long power cables (current capacity 120A) and one communication cable for each energy storage system:



6. Installation

6.1 Put battery modules into cabinet and connect the cables:

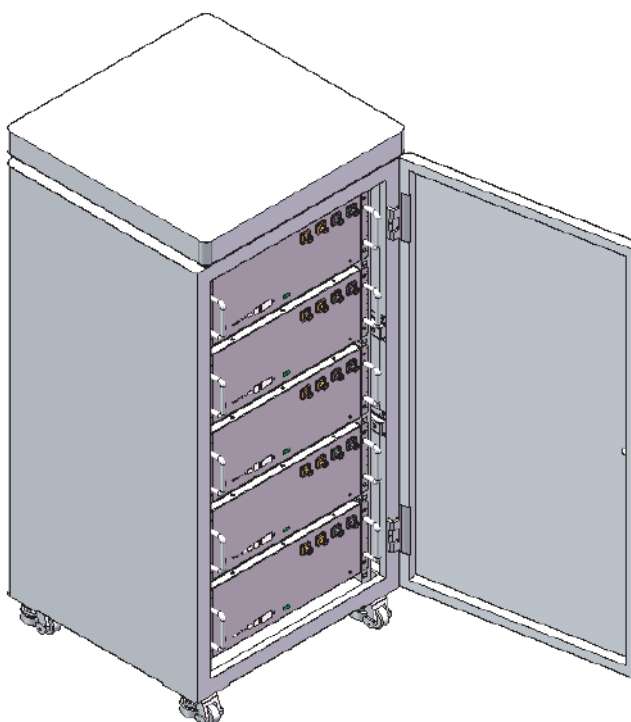

Note: If customer needs cabinet, please contact our salers

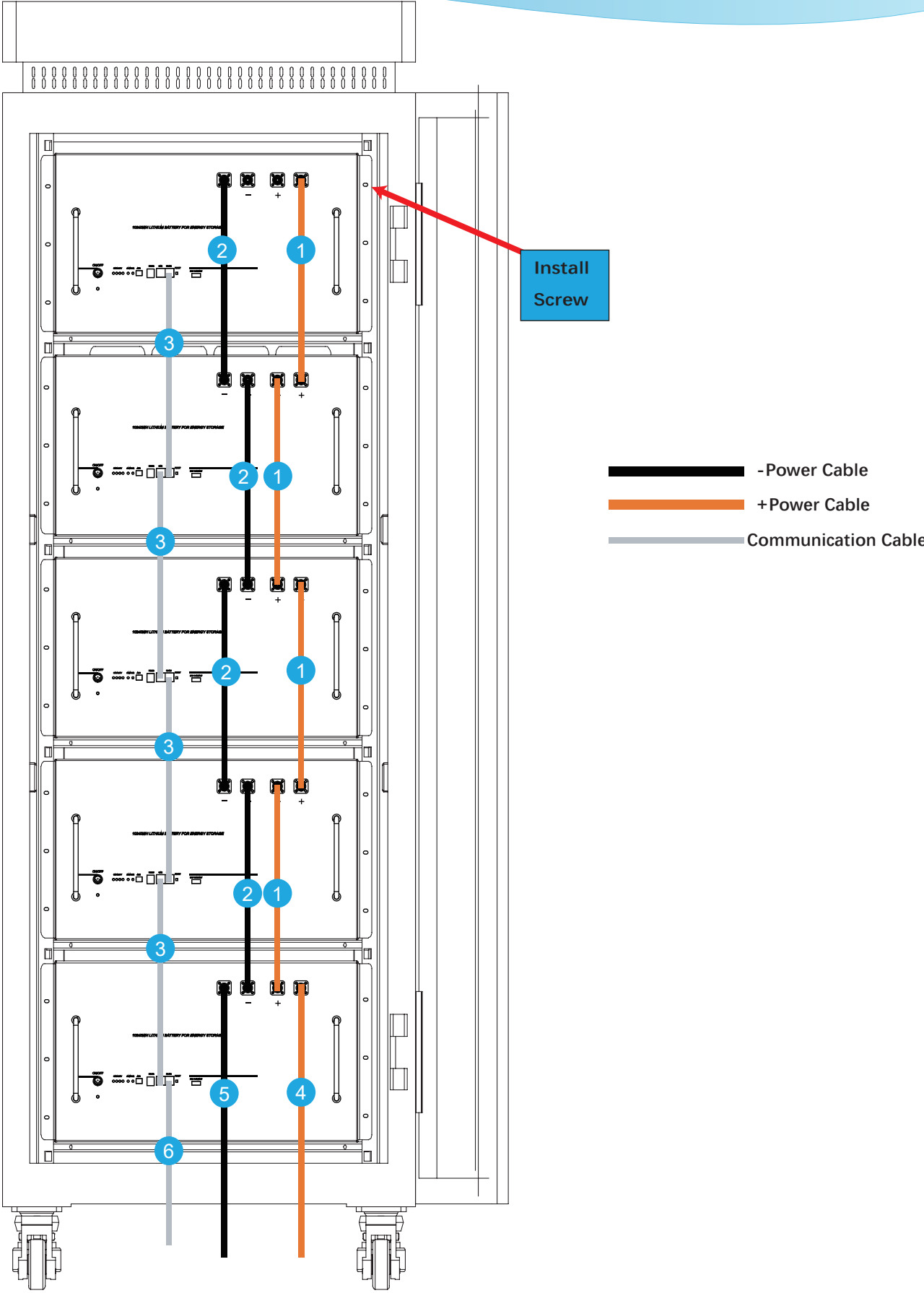

- (1) Put the battery into the cabinet;
- (2) Drive the 4 pcs screws;
- (3) Connect the cables between battery modules;
- (4) Connect the cables to inverter

6.2 Power On

Double check all the power cable and communication cable.

(1) ON/OFF

Switch on all the battery modules and the green LED light below will be on;

(2) Set ADD

Set ADD follow ADD instruction, pack 1 will be host, others are slaves.

7. Trouble Shooting Steps

7.1 Problem determination based on:

(1) Whether the battery can be turned on.

(2) If battery is turned on, check the red light is off, flashing or lighting:

(3) If the red light is off, check whether the battery can be charged/discharged.

7.2 Preliminary determination steps:

1) Battery cannot be turned on, switch on the lights are all no lighting or flashing. If the battery external switch is ON, the RUN light is flashing, and the external power supply voltage is 48V or more, the battery still unable to turn on, please contact distributor.

2) The battery can be turned on, but red light is lighting, and cannot be charged or discharged, red light is lighting, that means system is abnormal, please check values as following:

3) Temperature: Above 50°C or under -10°C, the battery could not work.

Solution: to move battery to the normal operating temperature range between -10°C and 50°C.

4) Current: If current is larger than 100A, battery protection will turn on.

Solution: Check whether current is too large or not, if it is, to change the settings on power supply side.

5) High Voltage: If charging voltage above 54.75V, battery protection will turn on.

Solution: Check whether voltage is too high or not, if it is, to change the settings on power supply side.

6) Low Voltage: When the battery discharges to 37.5V or less, battery protection will turn on.

Solution: Charge the battery for some time, the red light will turn off.

Excluding the four points above, if the faulty is still cannot be located, turn off battery and contact distributor.

7.3 The battery cannot be charged or discharged

(1) Cannot be charged:

Disconnect the power cables, measure voltage on power side, if the voltage is 52.97~54V, restart the battery, connect the power cable and try again, if still not work, turn off battery and contact distributor.

(2) Unable to discharge:

Disconnect the power cables and measure voltage on battery side, if it is under 37.5V, please charge the battery; if voltage is above 54.75V and still cannot discharge, turn off battery and contact distributor.

8. Emergency Situations

8.1 Leaking Batteries

If the battery pack leaks electrolyte, avoid contact with the leaking liquid or gas. If one is exposed to the leaked substance, immediately perform the actions described below.

Inhalation: Evacuate the contaminated area, and seek medical attention.

Contact with eyes: Rinse eyes with flowing water for 15 minutes, and seek medical attention.

Contact with skin: Wash the affected area thoroughly with soap and water, and seek medical attention.

Ingestion: Induce vomiting, and seek medical attention.

8.2 Fire

NO WATER! Only Hfc-227ea fire extinguisher can be used; if possible, move the battery pack to a safe area before it catches fire.

8.3 Wet Batteries

If the battery pack is wet or submerged in water, do not let people access it, and then contact distributor or an authorized dealer for technical support.

8.4 Damaged Batteries

Damaged batteries are dangerous and must be handled with the utmost care. They are not fit for use and may pose a danger to people or property. If the battery pack seems to be damaged, pack it in its original container, and return it to the authorized dealer.

NOTE

Damaged batteries may leak electrolyte or produce flammable gas. If such damage occurs,