









Solar Off-Grid Modules

Conventional Series (50 Wp - 160 Wp)



-  Easy installation and handling for various off-grid applications
-  Guaranteed power output with positive tolerance
-  High performance under low light conditions
(Cloudy days, mornings & evenings)
-  Manufactured according to international quality and environment management system
-  Available in Foldable and Flexible Solar modules
-  Superior quality raw materials used in production
-  Customisable as per requirement
-  OEM with branding and packing available

Gate Corp has been providing our solutions for more than a decade and have supported over 6000 MW (6 Giga Watt) of Solar plants across the globe. We are manufacturing off-grid solar modules with half cell and cut cells using high precision laser cutting of cells at our state-of-the-art manufacturing facility in India. Our plant is equipped in producing modules with both mono and poly crystalline solar PV cells. Strict adherence to quality and timeline separate us from our competition in this space. We also offer customised products in OEM and private labeling.

Solar Off-Grid Modules

Conventional Series (50 Wp - 160 Wp)

Cell Type	Mono/Poly Crystalline Cut Cells
Configuration	4 X 9
No. of Cells	36
Glass	High Transmission, Low Iron, Tempered Glass
Frame	Anodized Aluminum, Inhouse extrusion
Backsheet	White/Black

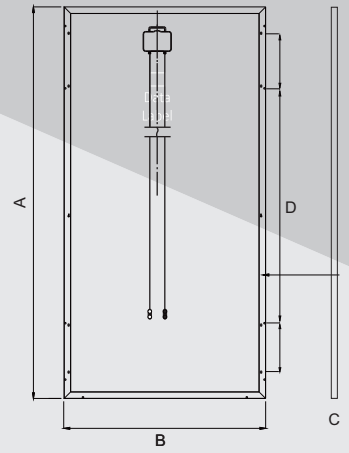

Electrical Data @ STC

Module Type	GSM-P50	GSM-P60	GSM-P80	GSM-P100	GSM-P160
Power (Pmax)	50	60	80	100	160
Voltage (Vmpp)	18	18	18	18	18
Open Circuit Voltage (Voc)	22	22	22	22	22
Shorting Circuit Current (Isc)	3.0	3.5	4.4	6.0	8.6
Maximum System Voltage (Vdc)	600 V				
Module Efficiency (%)	15% - 18%				
Power Tolerance (%)	+1 to 2%				

Temperature Ratings

Nominal Operating Cell Temperature (NOCT)	-40 °C to 85 °C
Temperature Co-efficient of Pmax	- 0.43%/K
Temperature Co-efficient of Vm	-0.36%/K
Temperature Coefficient of Im	+0.06%/K

Mechanical and Packing Configuration *

Module Type	GSM-P50	GSM-P60	GSM-P80	GSM-P100	GSM-P160
Module Dimensions (AxBxC) mm*	665x535x35mm	665X600X35	775x665x35	1030x665x35	1480x665x35
Installation Hole Dimensions (D) mm	611x450	586x450	450X628	611x640	900X628
Cable Length	On request				
Net Weight (Kg)	4.8	4.8	5.95	7.5	11
Quantity/Pallet (Nos.)	100pcs	90	70	52	45
Loading Capacity (20 Ft Container)	1400pcs/20ft	1200	950	800	625

* Mechanical and Packing Configuration may change as per Module dimensions

Warranty

5 years manufacturing warranty
 10 years warranty, 90% power output
 25 years warranty, 80% power output

