

OPzV12-150(12V150Ah)

OPzV series is Valve Regulated Lead Acid battery that adopts immobilized GEL and Tubular Plate technology to offer high reliability and performance. The Battery is designed and manufactured according to DIN standards and with die-casting positive grid and patented formula of active material OPzV series exceeds DIN standard values with more than 18 years floating design life at 25 °C and It is the best solution for cyclic use under extreme operating conditions.



Specification

Cells Per Unit	6
Voltage Per Unit	2
Nominal Capacity	150Ah@10hr-rate to 1.80V per cell @25°C
Weight	Approx. 54.0Kg (Tolerance±3.0%)
Internal Resistance	Approx. 7.0 mΩ
Terminal	F12(M8)
Max. Discharge Current	1500A (5 sec)
Design Life	20 years (floating charge)
Max. Charging Current	30.0 A
Reference Capacity	C3 109.9AH C5 123.2AH C10 150.0AH C20 159.9AH
Float Charging Voltage	13.5 V~13.8 V @ 25°C Temperature Compensation: -3mV/°C/Cell
Cycle Use Voltage	14.2 V~14.4 V @ 25°C Temperature Compensation: -4mV/°C/Cell
Operating Temperature Range	Discharge: -40°C~60°C Charge: -20°C~50°C Storage: -40°C~60°C
Normal Operating Temperature Range	25°C±5°C
Self Discharge	Valve Regulated Lead Acid (VRLA) batteries can be stored for up to 6 months at 25°C and then recharging is recommended. Monthly Self-discharge ratio is less than 2% at 20°C. Please charged batteries before using.
Container Material	A.B.S. UL94-HB, UL94-V0 Optional.

Dimensions

Unit: mm

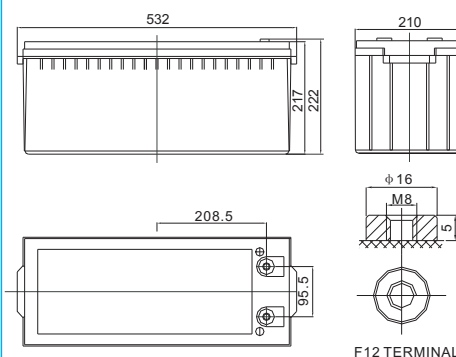

Length	532±2mm
Width	210±2mm
Height	217±2mm
Total Height	222±2mm
Torque Value	10~12 N*m

Constant Current Discharge Characteristics :A(25°C)

F.V/ Time	10min	15min	30min	1h	2h	3h	5h	8h	10h	20h
1.60V	229.1	183.9	121.8	83.83	51.94	40.25	26.46	17.82	14.98	7.865
1.65V	214.8	173.8	117.4	81.36	50.26	39.38	25.90	17.54	14.70	7.718
1.70V	196.4	162.0	112.2	78.62	48.58	38.07	25.34	17.26	14.42	7.571
1.75V	179.8	149.2	104.8	74.50	46.90	36.62	24.63	16.98	14.28	7.497
1.80V	156.7	133.5	97.46	69.97	44.66	35.02	23.79	16.56	14.00	7.350
1.85V	130.4	115.6	86.81	63.80	41.30	32.70	22.66	15.86	13.40	7.034

Constant Power Discharge Characteristics : WPC(25°C)

F.V/ Time	10min	15min	30min	1h	2h	3h	5h	8h	10h	20h
1.60V	359.4	298.2	223.7	158.9	99.26	77.46	51.52	35.23	29.54	15.51
1.65V	350.2	292.2	217.9	155.0	96.46	76.15	50.54	34.67	29.12	15.29
1.70V	332.3	280.8	210.3	150.9	93.80	73.82	49.55	34.25	28.70	15.07
1.75V	301.5	260.7	198.3	143.5	91.00	71.50	48.42	33.68	28.42	14.92
1.80V	259.4	236.3	186.0	135.6	86.94	68.30	46.74	32.84	27.86	14.63
1.85V	214.5	198.3	167.1	124.2	80.64	63.94	44.62	31.44	26.74	14.04

(Note) The above characteristics data are average values obtained within three charge/discharge cycle not the minimum values.

The battery must be fully charged before the capacity test. The C₁₀ should reach 95% after the first cycle and 100% after the third cycle.

OPzV12-150(12V150Ah)

Discharge Characteristics Curve

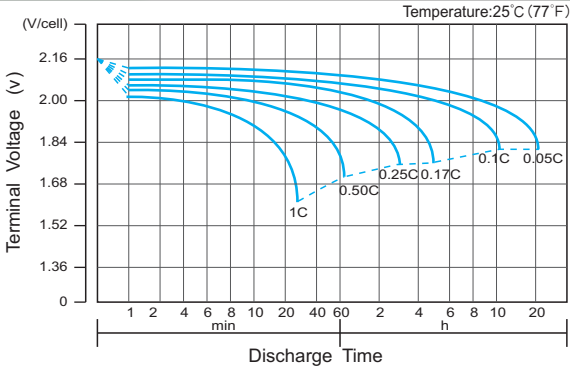

Charge Characteristic Curve for Cycle Use(IU)

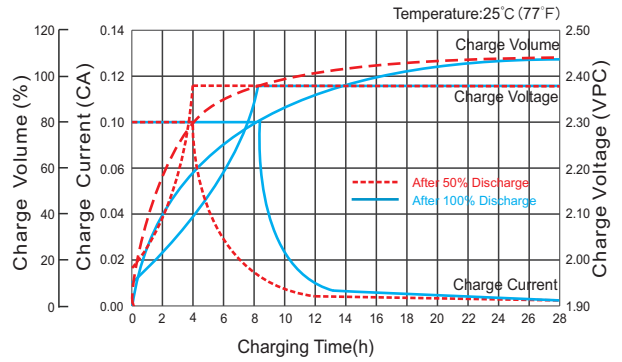

Cycle Life in Relation to Depth of Discharge

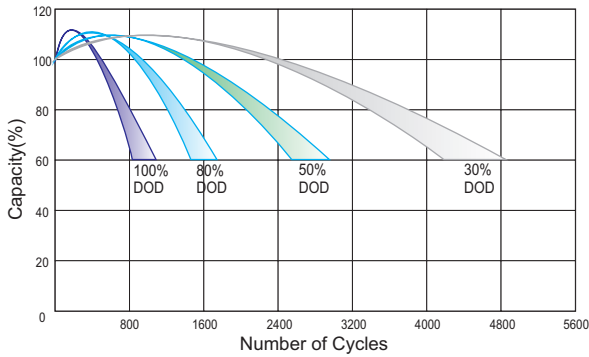

Relationship Between Charging Voltage and Temperature

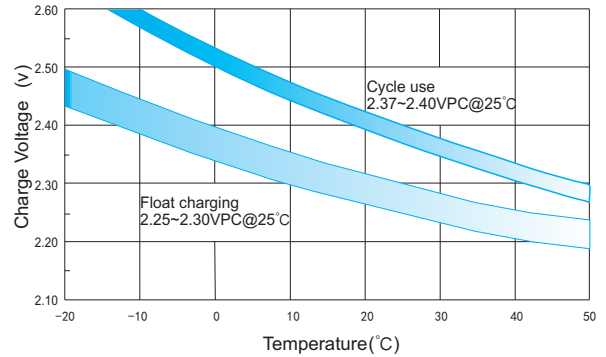

Temperature Effects on Capacity

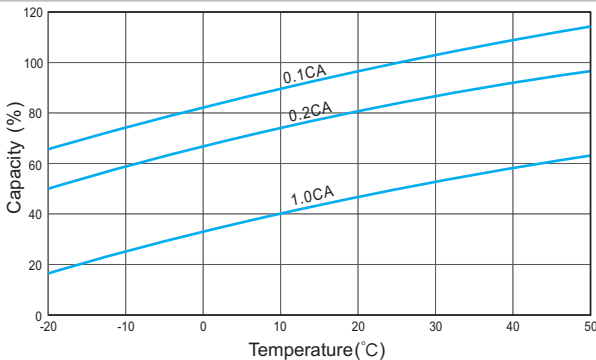

Storage Characteristics

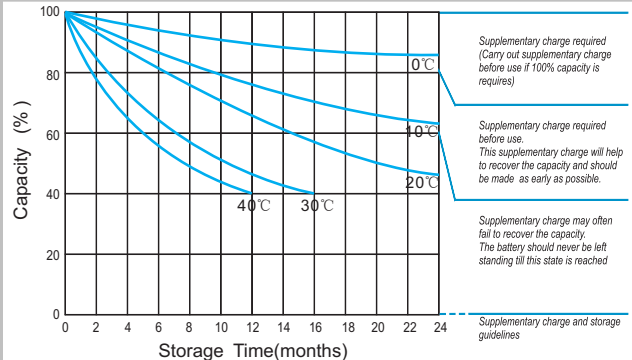

Effect of Temperature on Long Term Life

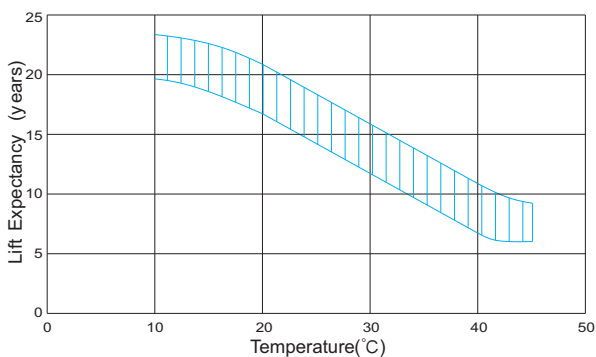

Relationship of OCV And State of Charge(20°C)

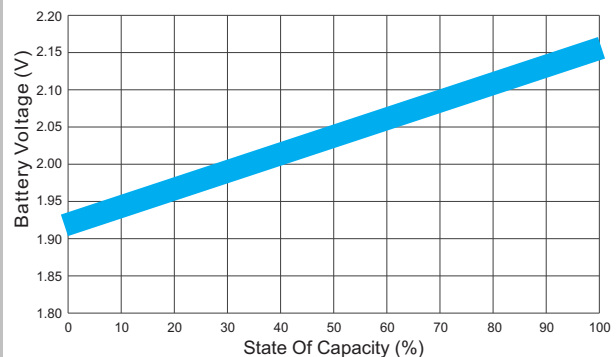

(Note) All above information shall be changed without prior notice, Ritar reserves the right to explain and update the latest information.