

12-100Ah (12V100Ah)



Specifications

Nominal Voltage		12 V
Rated capacity(10HR)		100Ah
Dimension	Length	407 ± 2mm (16.02inch)
	Width	173 ± 2mm (6.81inch)
	Height	208 ± 2mm (8.19inch)
	Total Height	233 ± 2mm (9.17inch)
Approx. Weight		28.8kg (63.5lbs) ± 3%

Dimensions

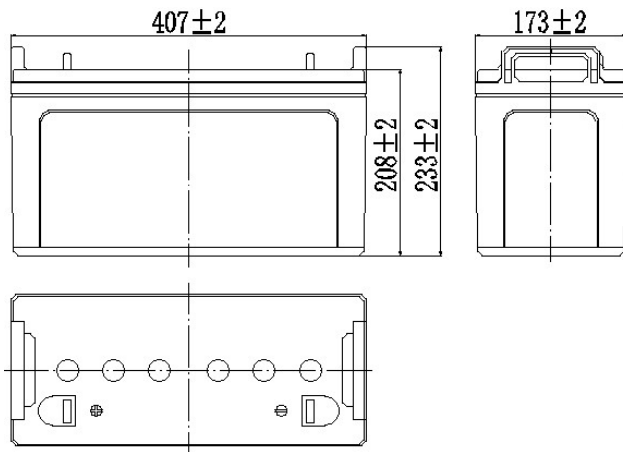

Characteristics

Capacity (25°C)	10HR(10.8V)	100 Ah
	3HR(10.8V)	75Ah
	1HR(10.5V)	55Ah
Terminal type		T9
Internal resistance (Fully charged, 25°C)		Approx. 6m Ω
Capacity affected by temperature (10HR)	40°C	102%
	25°C	100%
	0°C	85%
	-15°C	65%
Self-discharge (25°C)	3 month	Remaining Capacity: 91%
	6 month	Remaining Capacity: 82%
	12 month	Remaining Capacity: 65%
Nominal operating temperature		25°C ± 3°C (77°F ± 5°F)
Operating temperature range	Discharge	-15°C ~ 50°C (5°F ~ 122°F)
	Charge	-10°C ~ 50°C (14°F ~ 122°F)
	Storage	-20°C ~ 50°C (-4°F ~ 122°F)
Float charging voltage(25°C)		13.50 to 13.80V Temperature compensation: -18mV/°C
Cyclic charging voltage(25°C)		14.50 to 15.00V Temperature compensation: -30mV/°C
Maximum charging current		30A
Maximum discharge current		800A(5 sec.)
Designed floating life(20°C)		10 years

Terminal

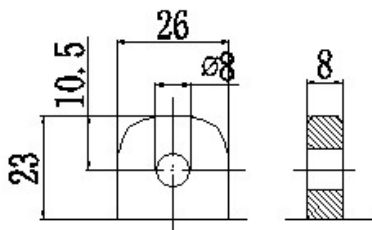

Construction

Component	Positive plate	Negative plate	Container	Cover	Separator	Electrolyte	Safety valve	Terminal
Raw material	Lead dioxide	Lead	ABS	ABS	AGM	Sulfuric acid	Rubber	Lead

Constant Current Discharge Characteristics (A, 25°C)

F.V/TIME	10min	15min	30min	60min	2h	3h	4h	5h	8h	10h	20h
9.60V	218	168	101	61.8	36.5	26.3	21.0	18.0	12.3	10.2	5.40
9.90V	211	164	98.5	60.9	36.3	26.2	20.9	17.8	12.3	10.2	5.38
10.2V	203	158	95.5	59.3	36.0	26.0	20.7	17.7	12.2	10.1	5.37
10.5V	194	153	93.2	57.5	35.5	25.8	20.6	17.6	12.1	10.1	5.34
10.8V	183	144	89.7	55.6	34.6	25.0	20.0	17.1	11.7	10.0	5.30

Constant Power Discharge Characteristics (Watt, 25°C)

F.V/TIME	10min	15min	30min	60min	2h	3h	4h	5h	8h	10h	20h
9.60V	2354	1845	1128	705	423	309	247	212	147	122	64.7
9.90V	2284	1800	1105	694	421	308	246	211	146	121	64.6
10.2V	2190	1734	1071	676	417	306	244	209	145	121	64.4
10.5V	2095	1675	1045	655	411	303	242	208	144	120	64.0

12-100Ah (12V100Ah)

10.8V	1978	1586	1007	634	400	294	235	202	139	119	63.6
-------	------	------	------	-----	-----	-----	-----	-----	-----	-----	------

Note: The above characteristics data can be obtained within three charge/discharge cycles.

Discharge Characteristics(25°C)

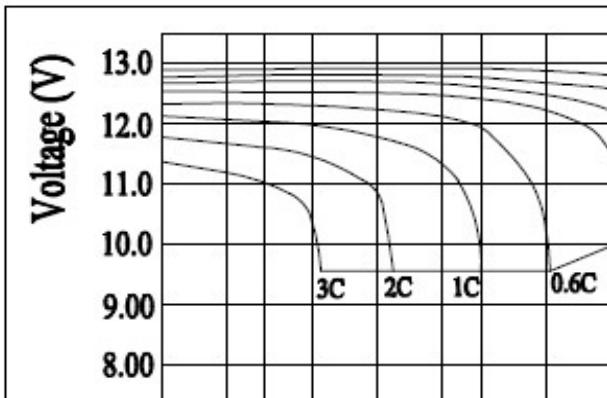

Charging Characteristics(25°C)

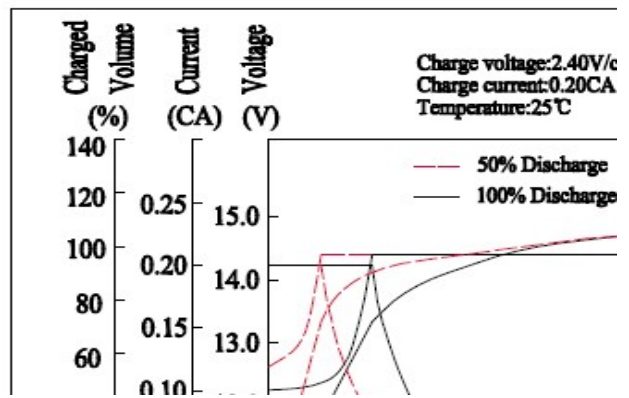

Effect of Temperature on Capacity



Self-discharge Characteristics

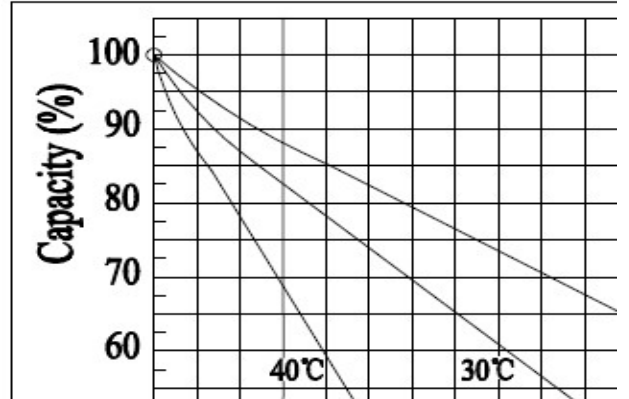

Floating Life on Temperature

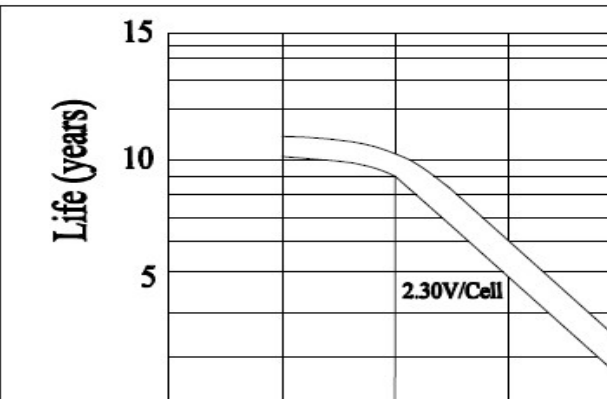

Cycle Life on D.O.D(25°C)

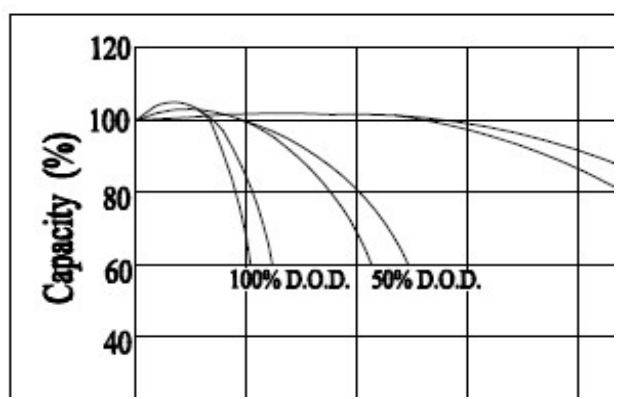

The Relationship for Open Circuit Voltage and Residual Capacity (25°C)

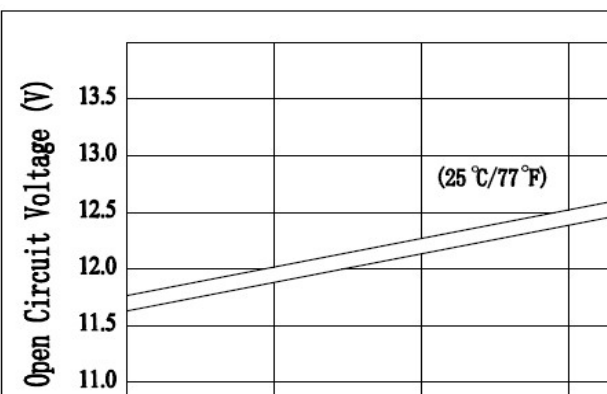

The Relationship for Charging Voltage and Temperature

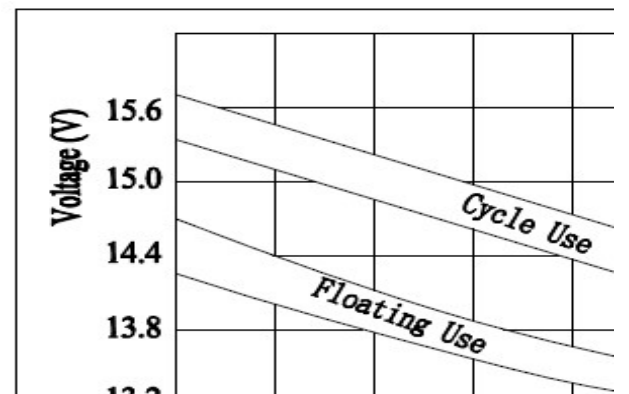

12-100Ah (12V100Ah)
