

XT Series 80



Your recycling needs. Our grinding solutions.

Granulators dedicated to scraps recovery from rigid or flexible extrusion for small sprues or heavy moulds, also suitable for second step grinding of pre-crushed pieces.

The granulators of this series, thanks to the special design of the grinding chamber, are also widely used for an immediate and safe in-line grinding of film and trims.

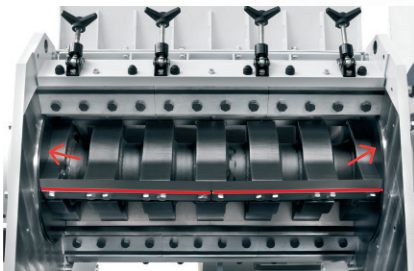

Arrow cutting configuration for 7 knives rotor. Rotary discs integral with the rotor and containment rings.



Scissors cutting configuration for 5 knives rotor. Bench adjustment of rotating and fixed knives.

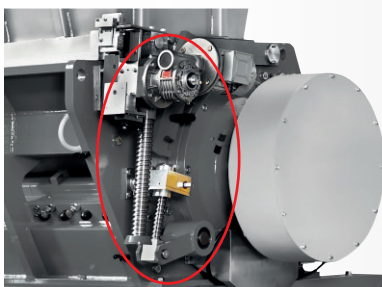

Hopper opening with motorized jack and screen-holder with manual jack.



Rotor lock device for maintenance. Safety devices and circuit in compliance with EEC Directives.



Keys for the fixing of motor pulley and flywheel. Pulley and flywheel manufactured as per drawing due to high inertia.

XT Series 80

FEATURES XT 10080

Feeding opening (mm): 1040 x 800
 Nr. rotating / fixed knives: 5 / 2
 Forged wet rotor: 6 / 2
 Rotor speed (RPM): 460
 Rotor diameter (mm): 620
 Motor (kW): 110
 Weight (kg): 9500
 Standard screen (mm): 12
 Indicative throughput (kg/hr): 1500 ÷ 1800

FEATURES XT 15080

Feeding opening (mm): 1560 x 800
 Nr. rotating / fixed knives: 5 - 7 / 2
 Forged wet rotor: 6 / 2
 Rotor speed (RPM): 460
 Rotor diameter (mm): 620
 Motor (kW): 132
 Weight (kg): 11300
 Standard screen (mm): 12
 Indicative throughput (kg/hr): 1800 ÷ 2200

OPTIONAL

- A) Knives and screen in antiwear execution
- B) Traction group
- C) Hopper for pipes and sheets
- D) Hopper with doors
- E) Wet grinding execution
- F) Fixed discs
- G) Pneumatic opening of screenholder
- H) Level control
- I) Bearings vibration monitoring
- L) Chamber temperature monitoring
- M) Discharge with suction group not on board
- N) III fixed knife

DIMENSIONS

	A	B	C	D	E
XT 10080	1910	2970	4050	2000	1034
XT 15080	2150	3100	4150	2604	1540

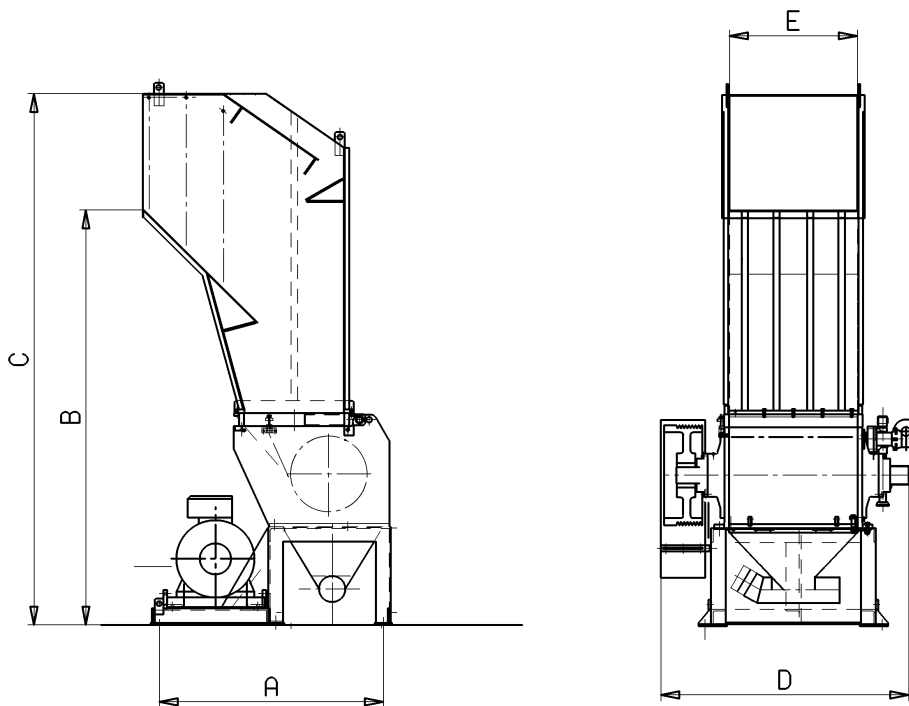

ACCESSORIES

Conveyor belt

Dust removing system LT

Suction group and filtering system

Granulator into a pit

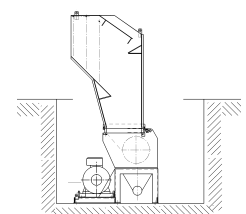
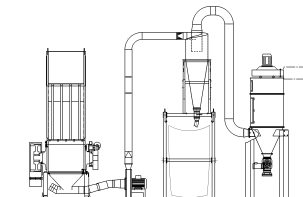
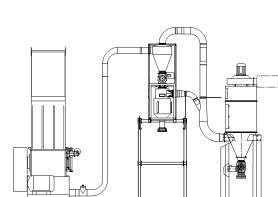
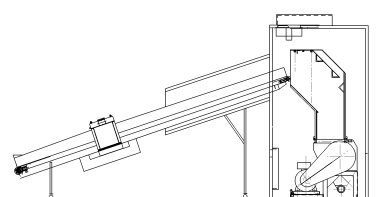

Your recycling needs. Our grinding solutions.

TRIA Italy
www.trioplastics.com

TRIA America
 TRIA Brazil

TRIA China
 TRIA Germany