

# BM Series 20

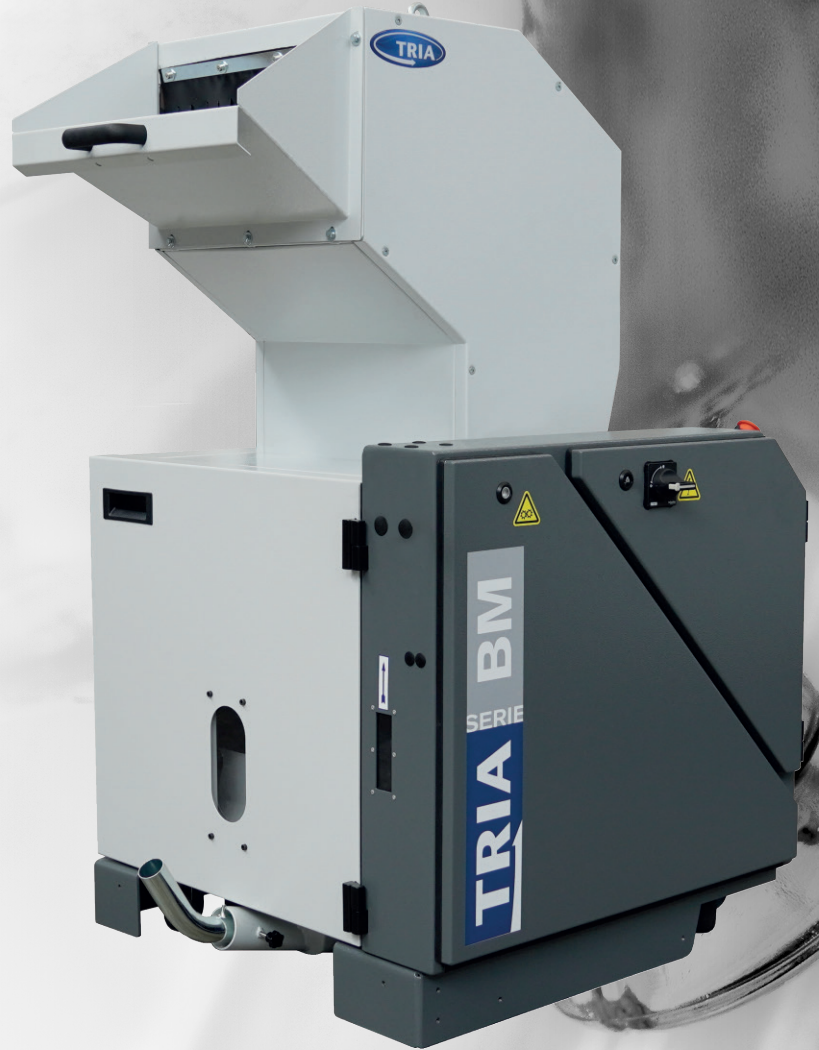

Your recycling needs. Our grinding solutions.

Granulators dedicated to small blow molding scrap recovery. The new BM 20 series can either work off-line or in-line. The compact footprint and the available options of the hoppers style guarantees flexibility for the customer needs.



Rotary discs integral with the rotor and containment rings. Scissors cutting configuration.

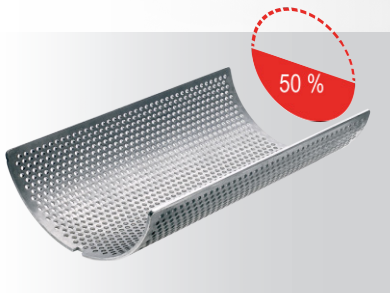

Grinding chamber suitable for small hollow pieces. Screen surface equal to approx. 50% of the knives rotation length.



Access without tools to the main parts subject to ordinary maintenance. Moving on castors.

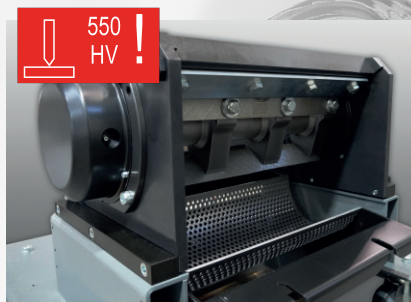

Grinding chamber in antiwear execution 550 HV. Roller bearings mounted to the grinding chamber and fixed to the circumference.



Integrated electric control panel. Safety devices and circuit in compliance with EEC Directives.

# BM Series 20

## FEATURES BM 4220

Feeding opening (mm): 420 x 200  
Nr. rotating / fixed knives: 3 / 2  
Rotor speed (RPM): 315  
Rotor diameter (mm): 180  
Motor (kW): 3  
Weight (kg): 380  
Standard screen (mm): 7  
Indicative throughput (kg/hr): 50 ÷ 80

## OPTIONAL

- A) Knives and screen in antiwear execution
- B) Soundproof rigid flap
- C) Not soundproof version
- D) Level control
- E) Discharge for hopper loader
- F) Discharge with auger screw
- G) EC extractor with storage
- H) Discharge with suction group on board
- I) Discharge with suction group not on board

## DIMENSIONS

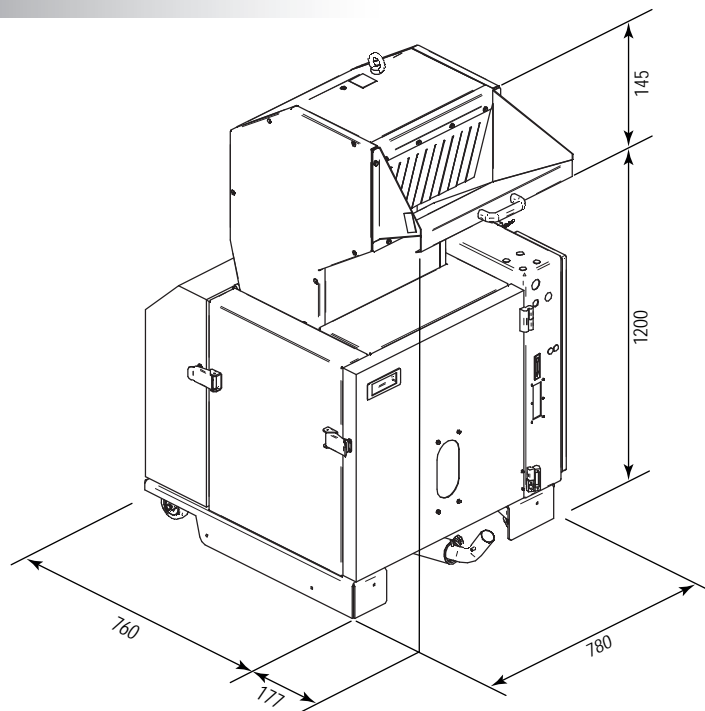

## ACCESSORIES

Suction group on board

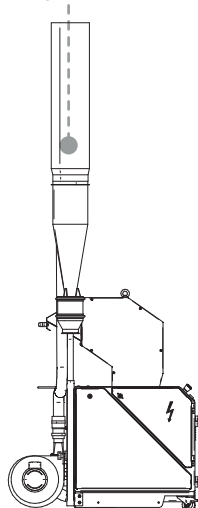

Dust removing system

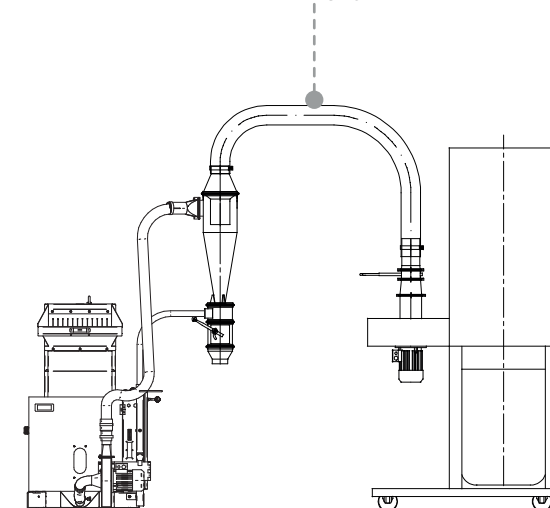

Auger screw

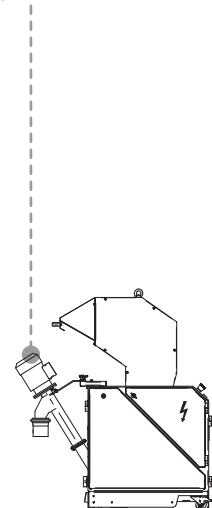

Your recycling needs. Our grinding solutions.

TRIA Italy  
[www.trioplastics.com](http://www.trioplastics.com)

TRIA America  
TRIA Brazil

TRIA China  
TRIA Germany