

K 8/25
K10/25
K13/25

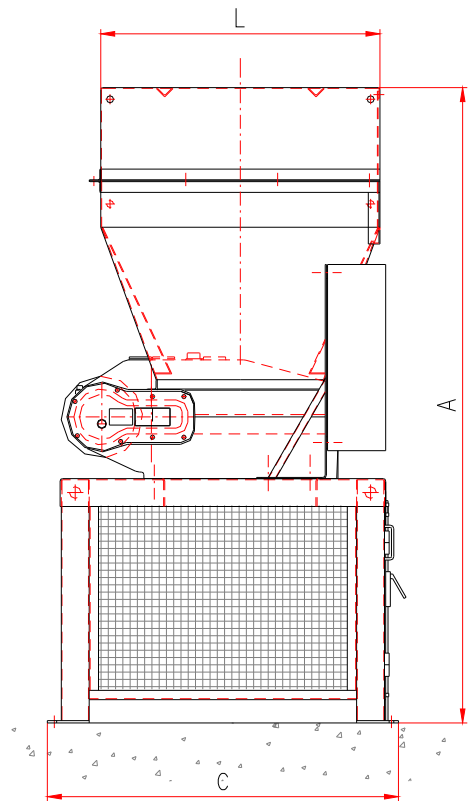

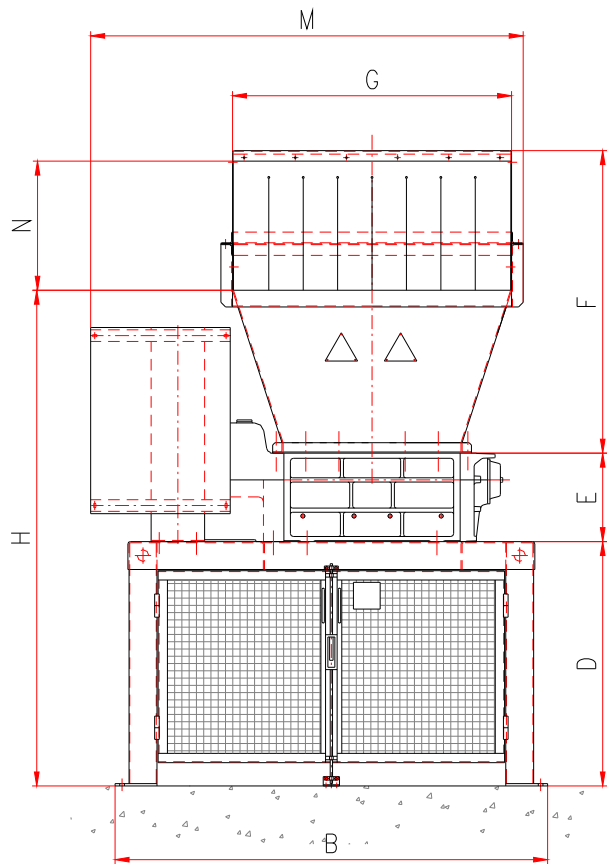



Dati tecnici Technical data	K 8/25	K 10/25	K 13/25
Camera di lavoro (mm) Shredding chamber (mm)	758x700	1008x700	1258x700
Lame da 30 mm (n.) 30 mm blades (no.)	25	33	41
Lame da 50 mm (n.) 50 mm blades (no.)	15	20	25
Potenza (kW) Power (kW)	18,5	18,5	18,5
Tensione (V) Voltage (V)	220/400/460	220/400/460	220/400/460
Peso (kg) Weight (kg)	2500	2810	3145

Per pezzature piccole e uniformi prevista versione con sistema a controlame "CL"
For small and uniform material shred size available version with "CL" Counter Blades System

Dati Tecnici/Technical Data



Esempi di materiali trattati / Some applications:

Plastica Plastics		400 ÷ 800 Kg/h
Bancali Pallets		40 ÷ 60 pcs/h
Rifiuti da catering Waste from catering		800 ÷ 1500 Kg/h
Fusti plastica (200/220 lt) Plastic drums (200/220 lt)		60 ÷ 90 pcs/h
Rifiuti industriali Industrial scraps		600 ÷ 1200 Kg/h
Pneumatici auto Car tyres		60 ÷ 150 pcs/h

	K8/25	K10/25	K13/25
A	2730	2730	2730
B	1860	1860	2110
C	1510	1510	1510
D	1050	1050	1050
E	380	380	380
F	1300	1300	1300
G	1200	1450	1700
H	2130	2130	2130
L	1200	1200	1200
M	1860	2085	2335
N	555	555	555

CAT1008 Rev. A.04/15

SatrindTech S.r.l.

Via Monfalcone, 122 - 20010 Arluno (MI) - Italy

Tel. (+39) 02 90376683

Fax (+39) 02 90376721

info@satrindtech.com

www.satrindtech.com

